

NUDURA  
Product Guide

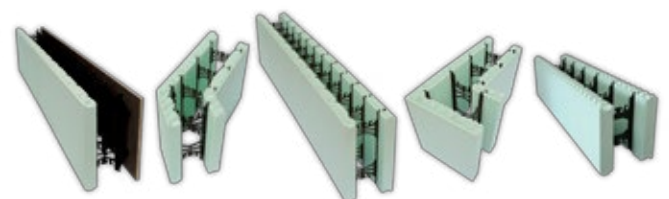
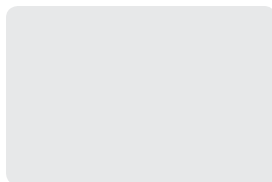
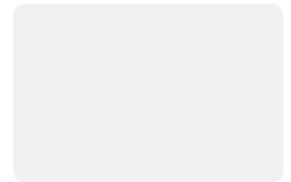
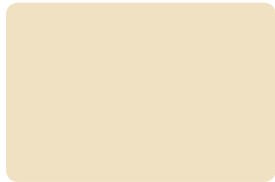
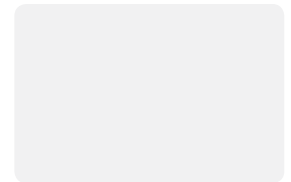
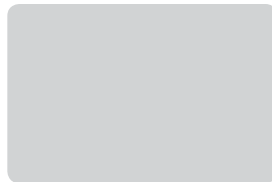

# TABLE OF CONTENTS

Introduction .....	3
Product Innovation .....	4
Product Lines .....	5
NUDURA ICF Series	
Assembled Forms:	
Standard Form .....	6
90° Form .....	7
45° Form .....	8
Taper Top Form .....	9
Brick Ledge Form .....	10
Radius Form .....	11
T-Form .....	12 - 13
Unassembled Forms:	
Standard Form .....	14
Taper Top Form .....	15
Double Sided Taper Top Form .....	16
Brick Ledge Form .....	17
Double Sided Brick Ledge Form .....	18
Brick Ledge & Taper Top Form .....	19
Optimizer Form .....	20
One Series .....	21 - 22
Plus Series	
NUDURA Plus Forms .....	23
R-Value Inserts .....	24
Integrated Series	
HYDROFOAM® .....	25
RetroFit .....	26
Ceiling Technology .....	27
Floor Technology .....	27
NOVOFOIL® .....	28
AIRCLAD® .....	29
NUDURA Form Accessories .....	30
NUDURA Accessories .....	31-35
NUDURA Alignment System .....	36-37
NUDURA Tall Wall Adapter Kit .....	38
Customer Service .....	39

© CMTA Engineering Consultants



Designed for  
Optimal Performance

Innovation Makes a  
Difference



Energy Efficient  
Building  
Envelope



Superior  
Customer Service

Training &  
Technical Support

Buildings today demand reliable, energy efficient, eco-friendly building envelopes that provide superior performance benefits to minimize energy costs, reduce carbon emissions, and maximize property value. NUDURA structures offer superior strength, storm, sound, and fire resistance, and are why the design community, developers, and contractors across the world continue to choose NUDURA's Integrated Building Technology® as a proven alternative to traditional building methods.

Our Insulated Concrete Forms provide design professionals, architects, home owners and contractors the freedom and versatility to design and build a structure the way it was envisioned. Building with NUDURA gives you the opportunity to build faster and more efficient, while offering your clients an eco-friendly structure with substantial benefits that contribute to long-term energy savings. When specifying NUDURA you can assure your customers that you are using the best building solution available today.

Architect: Nathalie Tremblay



NUDURA forms are manufactured with industry leading patented technologies that are exclusive to NUDURA, offering you a full line of innovative products designed to provide superior energy efficiency, greater strength, and sound resistance. Our building envelope provides an affordable eco-friendly building solution that allows you to build faster, more efficiently and offers substantial benefits over traditional construction.

## Innovation makes us the solution to better building.



- **DURALOK Technology**<sup>®</sup> - Securely locks forms into place with a triple tooth interlock eliminating the need to wire or glue forms, resulting in reduced labor costs during installation. Once the forms are stacked together a continuous full height-fastening strip ensures wall heights are always accurate, compared to other forms without full height-fastening which can cause wall height shrinkage once concrete is placed. DURALOK makes NUDURA the strongest in the industry.



- **DURAFOLD Technology**<sup>®</sup> - Patented hinged web technology allows the entire NUDURA form line up to fold and ship flat, allowing for 40% more product on a truck compared to other Insulated Concrete Form products. Once on-site, simply unfold and stack.



- **DURAMAX Technology**<sup>®</sup> - Largest standard form on the market measuring 96" x 18" (2438mm x 457mm). Our 96" (2438mm) form creates 60% fewer joints in the wall compared to other wall systems and allows installers the ability to place 12 sq.ft. (1.11 m<sup>2</sup>) of wall area with one block.



- **4-WAY REVERSIBLE System** - Patented foam interlock allows the form to be 4 way reversible, eliminating left and right corners, which helps speed up the building process and reduces product waste on-site.

Watch our Innovation Video  
at [nudura.com/innovation](http://nudura.com/innovation)



# nudura<sup>icf</sup> —series—

The NUDURA ICF Series is the leader in Insulated Concrete Form Innovation and technology and offers users the ability to combine a variety of products during the building process. The NUDURA ICF Series offers unique advantages over other products currently on the market.

DURAMAX Technology®  
DURAFOLD Technology®  
DURALOK Technology®  
The 4-Way Reversible System

# one<sup>1</sup> —series—

The One Series is the industry's only multi-link form system that enables the creation of a fully exposed concrete surface that extends to the face of a standard NUDURA form panel. This offers builders and architects unmatched versatility for projects designed to use ICFs. At the core of this innovative line is our DURA MULTI-LINK® Technology, a newly designed web that enables the builder to create custom multi-sided form combinations for a variety of commercial and residential building projects.

# plus<sup>+</sup> —series—

The Plus Series product line introduces an innovative way for designers and engineers to build their own R-value. Comprised of two new products, the Plus Form and the R-Value Plus+ insert, this product line offers the ability to optimize R-Value with thermal mass to provide significant energy savings for building owners. The NUDURA Plus Series allows professionals the ability to meet new installation requirements with one product.

# integrated<sup>↔</sup> —series—

The Integrated Series from NUDURA combines building envelope products that work in conjunction with our line of Insulated Concrete Forms to provide maximum energy efficiency. Each Integrated Series product has been manufactured to install quickly and efficiently and replaces many traditional forms of insulation products that are far more labor intensive.



**Preventol®** is an “imidacloprid” based **Termite Insecticide Treatment** that can be added at the manufacturing stage to any NUDURA ICF products. Preventol® is formally evaluated by the ICC-Evaluation Service for Termite Resistance as an insect treatment designed for use in EPS Foam. (ESR-2918). (NOTE: Product option is only available from NUDURA’s Southern US Plant location per USA Code Requirements.)



Close view of folding metal-hinged web

Assembled Product Shown Above

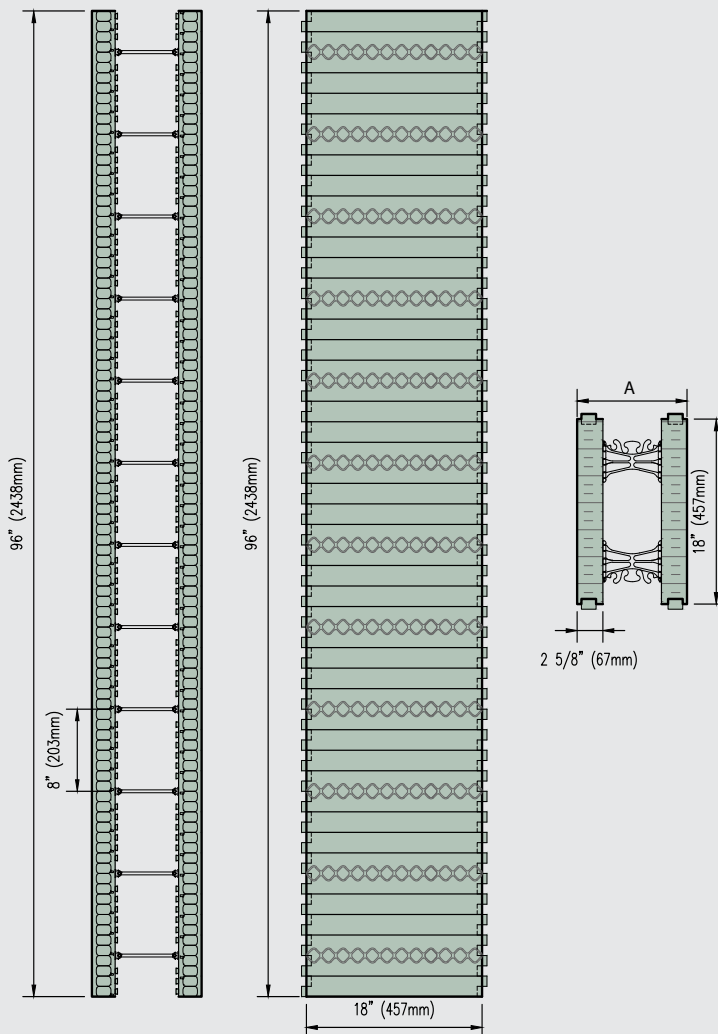

## MAY WE SUGGEST: FORM-LOCK

Used to maintain wall straightness. Other uses include wall alignment for vertical stack joints.



Available for 6" (150mm), 8" (200mm), 10" (250mm), 12" (300mm) Standard Forms.

Core Width	6" (150mm)	8" (200mm)	10" (250mm)	12" (300mm)
Length	10' (3m)	10' (3m)	10' (3m)	10' (3m)
Qty./Bundle	10 pcs	10 pcs	10 pcs	10 pcs
Code #	BLOK06	BLOK08	BLOK10	BLOK12

Visit the Resource Center on NUDURA's website ([nudura.com/resource-center](http://nudura.com/resource-center)) for design details, BIM library, installation links & more.

Refer to pages 30-35 for all related product accessories & tools.  
For additional information visit [nudura.com](http://nudura.com) or call 866-468-6299.

Core Width	4" (100mm)	6" (150mm)	8" (200mm)	10" (250mm)	12" (300mm)
Length	96" (2438mm)	96" (2438mm)	96" (2438mm)	96" (2438mm)	96" (2438mm)
Width A	9 1/4" (235mm)	11 1/4" (286mm)	13 1/4" (337mm)	15 1/4" (387mm)	17 1/4" (438mm)
Height	18" (457mm)	18" (457mm)	18" (457mm)	18" (457mm)	18" (457mm)
EPS Thickness	2 5/8" (67mm)	2 5/8" (67mm)	2 5/8" (67mm)	2 5/8" (67mm)	2 5/8" (67mm)
Qty./Bundle	3	3	3	3	3
Code #	96-4	96-6	96-8	96-10	96-12

Units come assembled with folding, metal-hinged webs.

Webs are included with assembled forms.

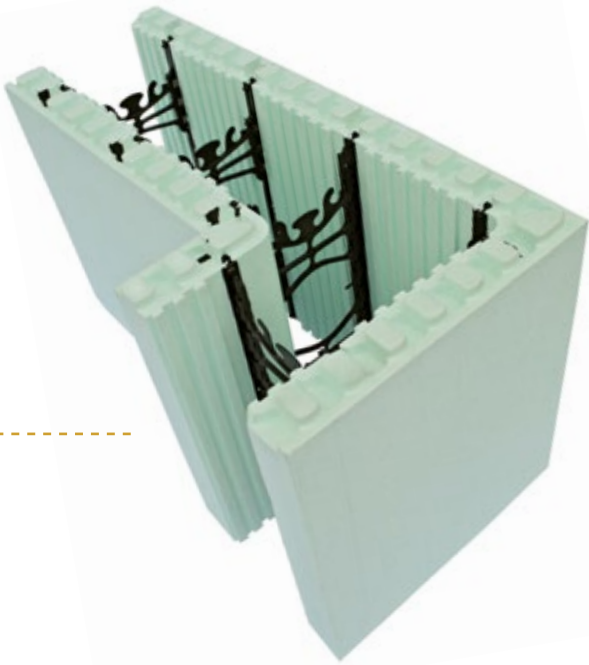

View of folding metal-hinged web and insert web for angled corner (included in order).

Assembled Product Shown Above

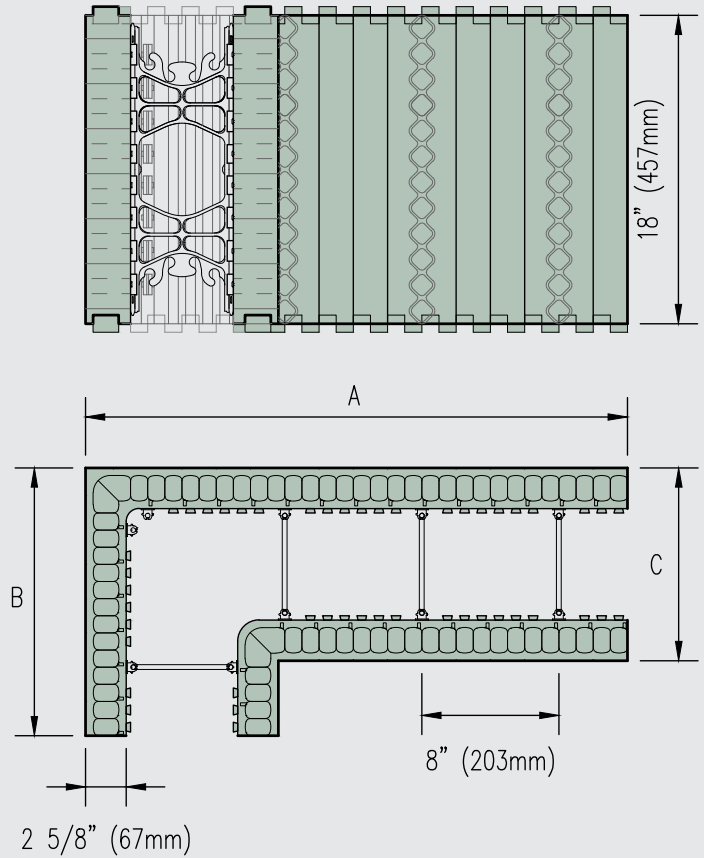

## MAY WE SUGGEST: Vertical Joint Clip

### 8 5/8" (219mm) Vertical Joint Clip

This metal clip is designed to connect the form together at the vertical joints. It replaces having to tie wire or tape forms together while providing a solid connection using minimal amount of labor to install.

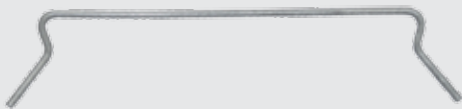

Qty./Box	200
Code #	VJC

Visit the Resource Center on NUDURA's website ([nudura.com/resource-center](http://nudura.com/resource-center)) for design details, BIM library, installation links & more.

Refer to pages 30-35 for all related product accessories & tools. For additional information visit [nudura.com](http://nudura.com) or call 866-468-6299.

Core Width	4" (100mm)	6" (150mm)	8" (200mm)	10" (250mm)	12" (300mm)
Length A	31 5/8" (803mm)	31 5/8" (803mm)	33 5/8" (854mm)	35 5/8" (905mm)	37 5/8" (956mm)
Length B	15 5/8" (397mm)	15 5/8" (397mm)	17 5/8" (448mm)	19 5/8" (498mm)	21 5/8" (549mm)
Width C	9 1/4" (235mm)	11 1/4" (286mm)	13 1/4" (337mm)	15 1/4" (387mm)	17 1/4" (438mm)
Height	18" (457mm)	18" (457mm)	18" (457mm)	18" (457mm)	18" (457mm)
Qty./Bundle	6	6	6	4	4
Code #	90-4	90-6	90-8	90-10	90-12

Units come assembled with folding metal-hinged webs.

Webs are included with assembled forms.

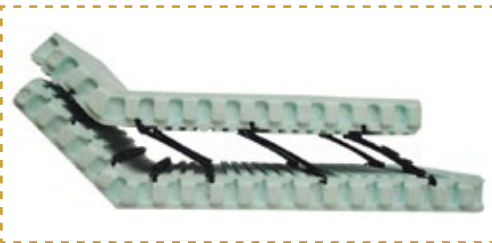

View of folding metal-hinged web and insert web for angled corner (included in order).

Assembled Product Shown Above

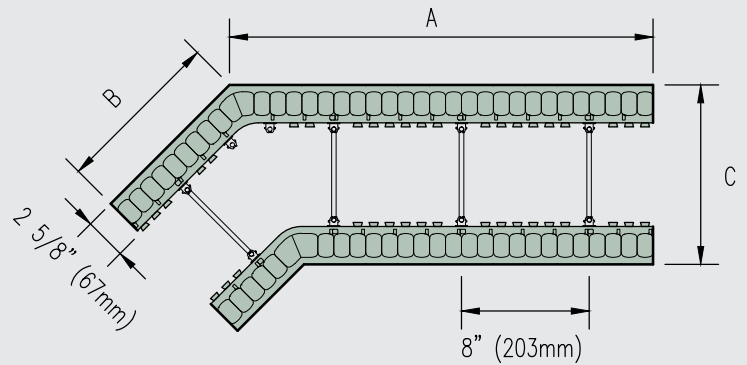
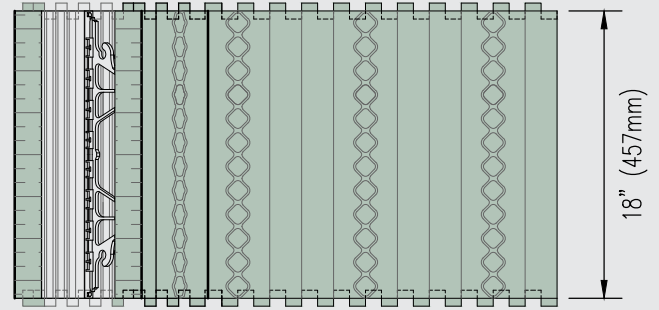

## MAY WE SUGGEST: Vertical Joint Clip

### 8 5/8" (219mm) Vertical Joint Clip

This metal clip is designed to connect the form together at the vertical joints. It replaces having to tie wire or tape forms together while providing a solid connection using minimal amount of labor to install.

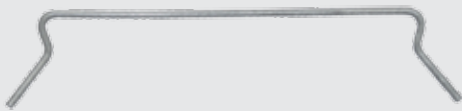

Qty./Box	200
Code #	VJC

Visit the Resource Center on NUDURA's website ([nudura.com/resource-center](http://nudura.com/resource-center)) for design details, BIM library, installation links & more.

Refer to pages 30-35 for all related product accessories & tools. For additional information visit [nudura.com](http://nudura.com) or call 866-468-6299.

Core Width	4" (100mm)	6" (150mm)	8" (200mm)	10" (250mm)	12" (300mm)
Length A	26 1/2" (673mm)	26 1/2" (673mm)	26 1/2" (673mm)	28 1/2" (724mm)	30 1/2" (775mm)
Length B	10 1/2" (267mm)	10 1/2" (267mm)	10 1/2" (267mm)	12 1/2" (318mm)	14 1/2" (368mm)
Width C	9 1/4" (235mm)	11 1/4" (286mm)	13 1/4" (337mm)	15 1/4" (387mm)	17 1/4" (438mm)
Height	18" (457mm)	18" (457mm)	18" (457mm)	18" (457mm)	18" (457mm)
Qty./Bundle	6	6	6	4	4
Code #	45-4	45-6	45-8	45-10	45-12

Units come assembled with folding, metal-hinged webs.

Webs are included with assembled forms.





Close view of folding metal-hinged web

Assembled Product Shown Above

## MAY WE SUGGEST: Heavy Duty Tape

4" Heavy Duty Tape - 4' x 260' (96mm x 66m)

Used for covering the interlock at the top of a wall to protect it from concrete getting into the sockets. Can also be used as an air barrier tape.



Qty./Box	24
Code #	TAP4HD

Visit the Resource Center on NUDURA's website ([nudura.com/resource-center](http://nudura.com/resource-center)) for design details, BIM library, installation links & more.

Refer to pages 30-35 for all related product accessories & tools.  
For additional information visit [nudura.com](http://nudura.com) or call 866-468-6299.

2 5/8" (67mm) 5/8" (16mm)

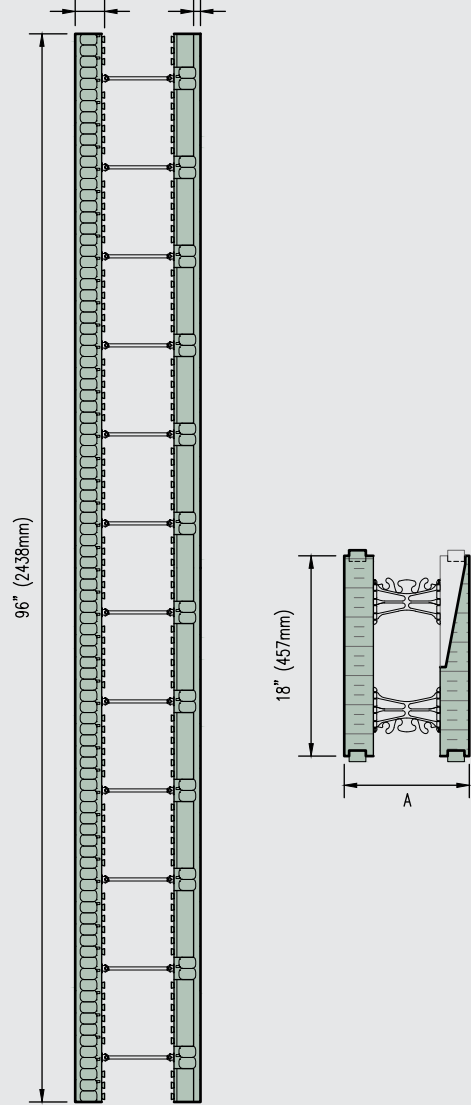

Assembled 96" (2438mm) One-Sided Taper Top Shown Above

Core Width	4" (100mm)	6" (150mm)	8" (200mm)	10" (250mm)	12" (300mm)
Length - 96"		96" (2438mm)	96" (2438mm)		
Qty./Bundle		3	3		
Code #		TT96-6	TT96-8		

Webs are included with assembled units.

- Units come assembled with folding, metal-hinged webs.
- Only available as an unassembled Form Unit. Refer to page 15 for order information.

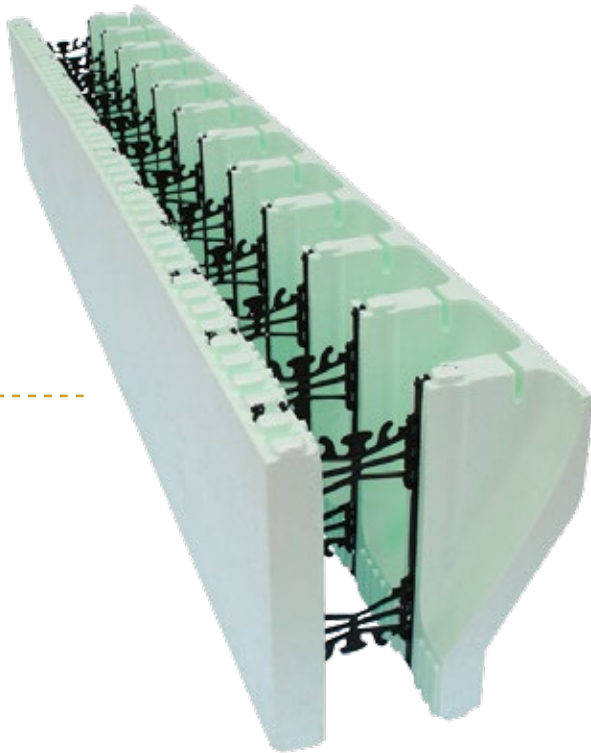

Close view of folding metal-hinged web

Assembled Product Shown Above

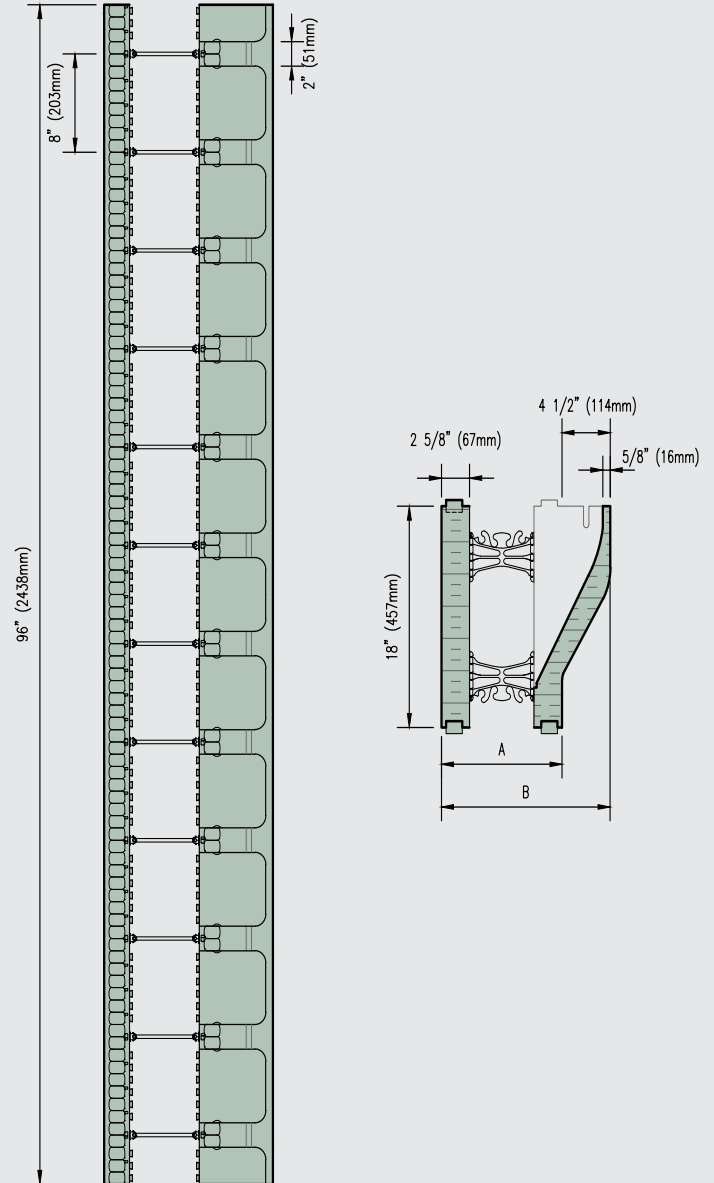

Assembled 96" (2438mm) Molded Brick Ledge Shown Above

## MAY WE SUGGEST: Brick Ledge Extension

### Brick Ledge Extension

Used for supporting standard brick or stone veneer finishes, when constructing brick ledges at corners, and can be installed to meet any elevation change or slope.

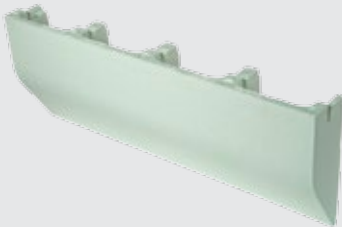

Qty./Bundle	14
Code #	BRICK

Refer to page 20 for more order information.

Refer to pages 30-35 for all related product accessories & tools.  
For additional information visit [nudura.com](http://nudura.com) or call 866-468-6299.

Core Width	4" (100mm)	6" (150mm)	8" (200mm)	10" (250mm)	12" (300mm)
Width A		11 1/4" (268mm)	13 1/4" (337mm)		
Height		15 1/4" (457mm)	17 3/4" (457mm)		
Length - 48"		48" (1219mm)	48" (1219mm)		
Qty./Bundle		4	4		
Code #		BRI-6	BRI-8		
Webs are included with assembled units.					
Length - 96"		96" (2438mm)	96" (2438mm)		
Qty./Bundle		2	2		
Code #		BR96-6	BR96-8		
Webs are included with assembled units.					

- Units come assembled with folding, metal-hinged webs.
- Units come assembled with folding, insert webs.
- Only available as an unassembled Form Unit. Refer to page 17 for order info.

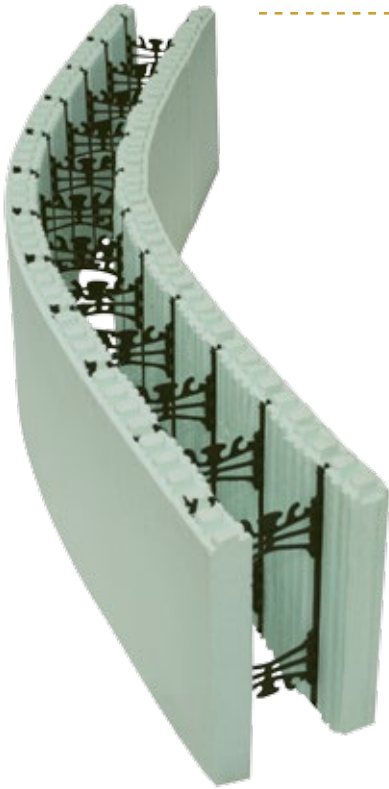

Close view of folding metal-hinged web

Assembled Product Shown Above

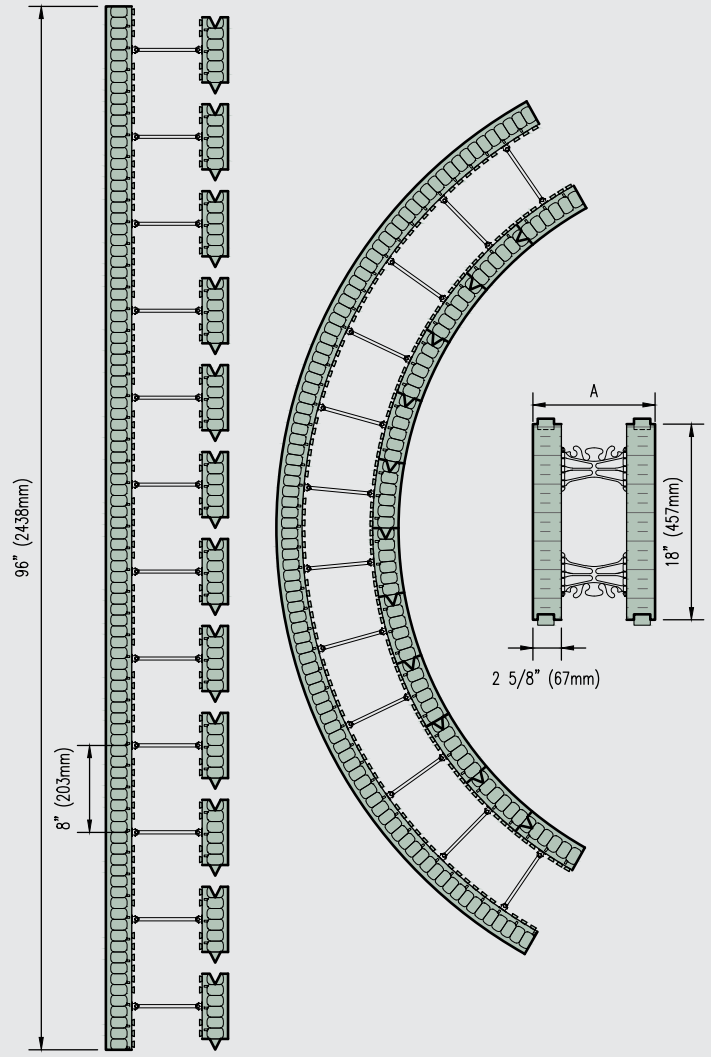

## MAY WE SUGGEST: Parging Mix & Fiber Mesh

### Parging Mix and Fiber Mesh

The parge mix is a dry cementitious product that is used to cover exposed EPS that is not covered by an exterior finish. Used in conjunction with Fiber Mesh. The Fiber Mesh gets embedded into the parge coat to give it strength.



Parging Mix  
Coverage - 75 sq ft (7m<sup>2</sup>)



Fiber Mesh  
Coverage - 475 sq ft (44m<sup>2</sup>)

Qty./Each	1 BAG
Code #	PARG

Qty./Each	1 ROLL
Code #	MESH

Core Width	4" (100mm)	6" (150mm)	8" (200mm)	10" (250mm)	12" (300mm)
Length	96" (2438mm)	96" (2438mm)	96" (2438mm)q	96" (2438mm)	96" (2438mm)
Width	9 1/4" (235mm)	11 1/4" (286mm)	13 1/4" (337mm)	15 1/4" (387mm)	17 1/4" (438mm)
Height	18" (457mm)	18" (457mm)	18" (457mm)	18" (457mm)	18" (457mm)
Radius	Manufactured to Specifications.				
Qty./Bundle	Varies with radius size. Contact your local distributor for details.				
Code #	RAD-4	RAD-6	RAD-8	RAD-10	RAD-12

Units come assembled with folding metal-hinged webs.

Refer to pages 30-35 for all related product accessories & tools.  
For additional information visit [nudura.com](http://nudura.com) or call 866-468-6299.

Refer to NUDURA's Installation Manual for the Radius Form Calculator.  
Visit the Resource Center on NUDURA's website ([nudura.com/resource-center](http://nudura.com/resource-center))  
for design details, BIM library, installation links & more.

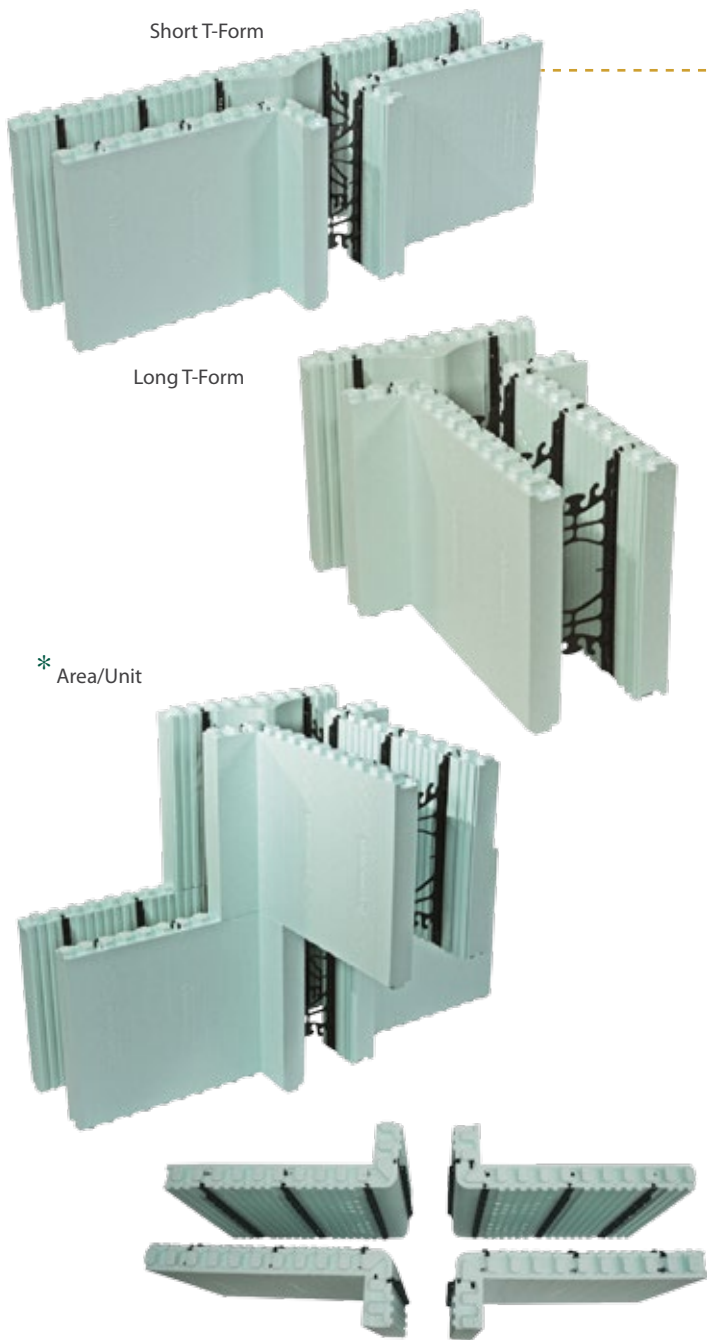

Short T-Form

Long T-Form

\* Area/Unit

S-TW-6 \*\* T-Cross - Webs ordered separately.

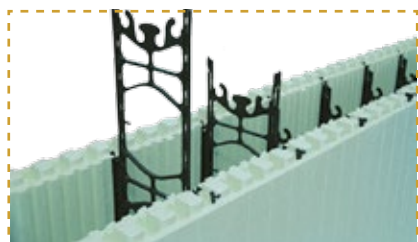

Close view of insert webs - Webs are included with order

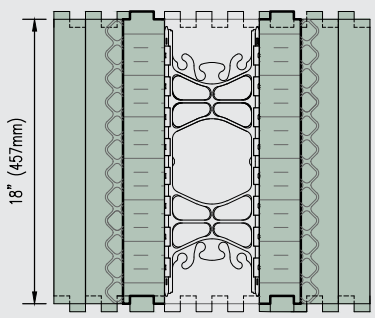
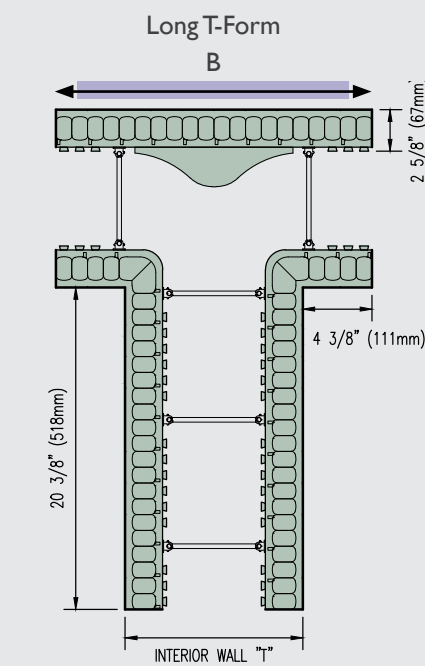
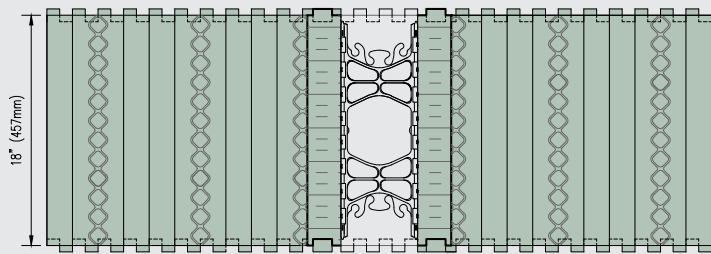
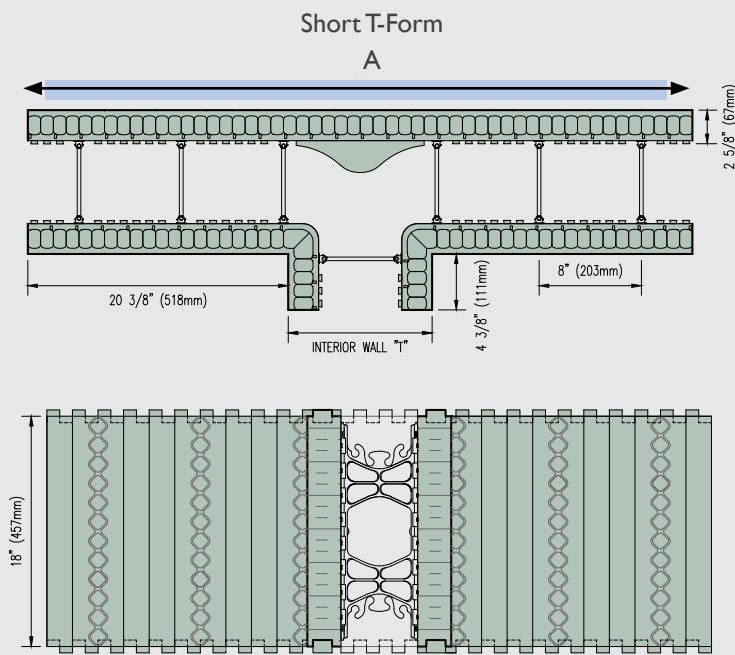

## Webs are Included - Site Assembly Required

Refer to pages 30-35 for all related product accessories & tools.  
For additional information visit [nudura.com](http://nudura.com) or call 866-468-6299.

For more form dimensions refer to NUDURA's Installation Manual.

## Bundle Includes 4 Courses - 2 Short and 2 Long T-Forms

Main Wall - represents the concrete core of the outside form

Interior Wall "T" - represents the concrete core of the inside form that joins to the Main Wall

CORE WIDTH	Main Wall	4" (100mm)	6" (150mm)	8" (200mm)	10" (250mm)	12" (300mm)
Interior Wall - T 4" (100mm)	Short T-Form Length (A)	50" (1270mm)	50" (1270mm)	50" (1270mm)	50" (1270mm)	50" (1270mm)
	Long T-Form Length (B)	18" (457mm)	18" (457mm)	18" (457mm)	18" (457mm)	18" (457mm)
	Area/Unit*	11 ½ ft² (1.068m²)	11 ½ ft² (1.068m²)	11 ½ ft² (1.068m²)	11 ½ ft² (1.068m²)	11 ½ ft² (1.068m²)
	Bundle Code #	T4-M4	T4-M6	T4-M8	T4-M10	T4-M12
Interior Wall - T 6" (150mm)	Short T-Form Length (A)	52" (1321mm)	52" (1321mm)	52" (1321mm)	52" (1321mm)	52" (1321mm)
	Long T-Form Length (B)	20" (508mm)	20" (508mm)	20" (508mm)	20" (508mm)	20" (508mm)
	Area/Unit*	12 ft² (1.115m²)	12 ft² (1.115m²)	12 ft² (1.115m²)	12 ft² (1.115m²)	12 ft² (1.115m²)
	Bundle Code #	T6-M4	T6-M6	T6-M8	T6-M10	T6-M12
Interior Wall - T 8" (200mm)	Short T-Form Length (A)	54" (1372mm)	54" (1372mm)	54" (1372mm)	54" (1372mm)	54" (1372mm)
	Long T-Form Length (B)	22" (559mm)	22" (559mm)	22" (559mm)	22" (559mm)	22" (559mm)
	Area/Unit*	12 ½ ft² (1.161m²)	12 ½ ft² (1.161m²)	12 ½ ft² (1.161m²)	12 ½ ft² (1.161m²)	12 ½ ft² (1.161m²)
	Bundle Code #	T8-M4	T8-M6	T8-M8	T8-M10	T8-M12
Interior Wall - T 10" (250mm)	Short T-Form Length (A)	56" (1422mm)	56" (1422mm)	56" (1422mm)	56" (1422mm)	56" (1422mm)
	Long T-Form Length (B)	24" (610mm)	24" (610mm)	24" (610mm)	24" (610mm)	24" (610mm)
	Area/Unit*	13 ft² (1.208m²)	13 ft² (1.208m²)	13 ft² (1.208m²)	13 ft² (1.208m²)	13 ft² (1.208m²)
	Bundle Code #	T10-M4	T10-M6	T10-M8	T10M10	T10M12
Interior Wall - T 12" (300mm)	Short T-Form Length (A)	58" (1473mm)	58" (1473mm)	58" (1473mm)	58" (1473mm)	58" (1473mm)
	Long T-Form Length (B)	26" (660mm)	26" (660mm)	26" (660mm)	26" (660mm)	26" (660mm)
	Area/Unit*	13 ½ ft² (1.254m²)	13 ½ ft² (1.254m²)	13 ½ ft² (1.254m²)	13 ½ ft² (1.254m²)	13 ½ ft² (1.254m²)
	Bundle Code #	T12-M4	T12-M6	T12-M8	T12M10	T12M12

**\*\* Special Order:** Code #S-TW-6: T-Cross Form Unit Unassembled - 4 panels per T-Cross (4 T-Cross Form Units per bundle) - 32 webs required per bundle. Webs ordered separately. Refer to page 15 for web order information.

Short T-Form Main Exterior Wall Length. Webs are included.

Long T-Form Main Exterior Wall Length. Webs are included.

\*Area/Unit - a unit represents one Short T-Form and one Long T-Form connected together forming 2 courses (reference photo on left).

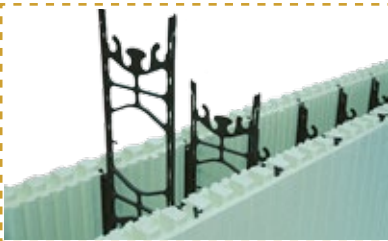

Close view of insert webs - available in 4"-12" (100-300mm) sizes

Unassembled Product Shown Above

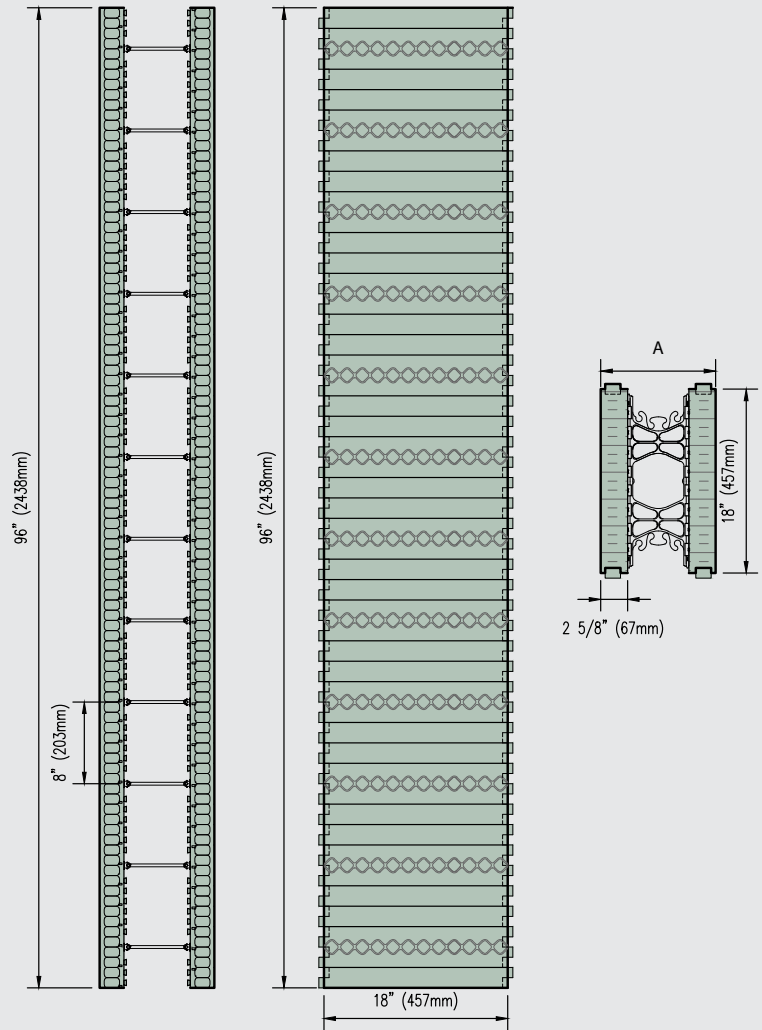

## Insert Webs (Ordered Separately)

### Small Box

Core Width	4" (100mm)	6" (150mm)	8" (200mm)	10" (250mm)	12" (300mm)
Qty./Box	100	100	100	100	100
Code #	WEB-4	WEB-6	WEB-8	WEB-10	WEB-12

### Large Box

Core Width	4" (100mm)	6" (150mm)	8" (200mm)	10" (250mm)	12" (300mm)
Qty./Box	957	655	465	388	295
Code #	WEB4	WEB6	WEB8	WEB10	WEB12

Core Width	4" (100mm)	6" (150mm)	8" (200mm)	10" (250mm)	12" (300mm)
Length	96" (2438mm)	96" (2438mm)	96" (2438mm)	96" (2438mm)	96" (2438mm)
Width A	9 1/4" (235mm)	11 1/4" (286mm)	13 1/4" (337mm)	15 1/4" (387mm)	17 1/4" (438mm)
Height	18" (457mm)	18" (457mm)	18" (457mm)	18" (457mm)	18" (457mm)
Qty./Bundle	Includes: 6 Standard Panels (3 pairs per bundle)				
Code #	Panel	Panel	Panel	Panel	Panel
Web Qty. Req'd/Bundle	36	36	36	36	36

- Units come unassembled.
- Insert webs required per bundle - refer to web order chart on left.

Visit the Resource Center on NUDURA's website ([nudura.com/resource-center](http://nudura.com/resource-center)) for design details, BIM library, installation links & more.

Refer to pages 30-35 for all related product accessories & tools. For additional information visit [nudura.com](http://nudura.com) or call 866-468-6299.

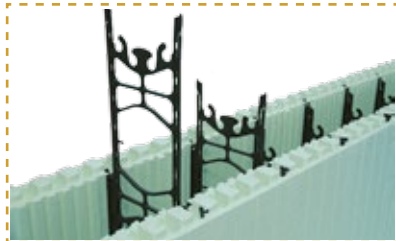

Close view of insert webs - available in 4"-12" (100-300mm) sizes

Unassembled Product Shown Above

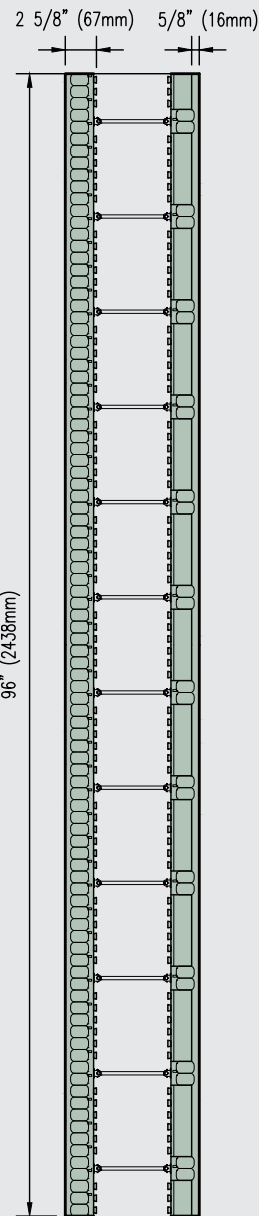

## Insert Webs (Ordered Separately)

### Small Box

Core Width	4" (100mm)	6" (150mm)	8" (200mm)	10" (250mm)	12" (300mm)
Qty./Box	100	100	100	100	100
Code #	WEB-4	WEB-6	WEB-8	WEB-10	WEB-12

### Large Box

Core Width	4" (100mm)	6" (150mm)	8" (200mm)	10" (250mm)	12" (300mm)
Qty./Box	957	655	465	388	295
Code #	WEB4	WEB6	WEB8	WEB10	WEB12

Core Width	4" (100mm)	6" (150mm)	8" (200mm)	10" (250mm)	12" (300mm)
Overall Width A	9 1/4" (235mm)	11 1/4" (286mm)	13 1/4" (337mm)	15 1/4" (387mm)	17 1/4" (438mm)
Length - 96"	96" (2438mm)	96" (2438mm)	96" (2438mm)	96" (2438mm)	96" (2438mm)
Qty./Bundle	Includes: 3 Taper Top Panels & 3 Standard Panels				
Code #	TT96-P	TT96-P	TT96-P	TT96-P	TT96-P
Web Qty. Req'd/Bundle	36	36	36	36	36

Visit the Resource Center on NUDURA's website ([nudura.com/resource-center](http://nudura.com/resource-center)) for design details, BIM library, installation links & more.

Refer to pages 30-35 for all related product accessories & tools. For additional information visit [nudura.com](http://nudura.com) or call 866-468-6299.

- Units come unassembled.
- Insert webs required per bundle - refer to web order chart on left.

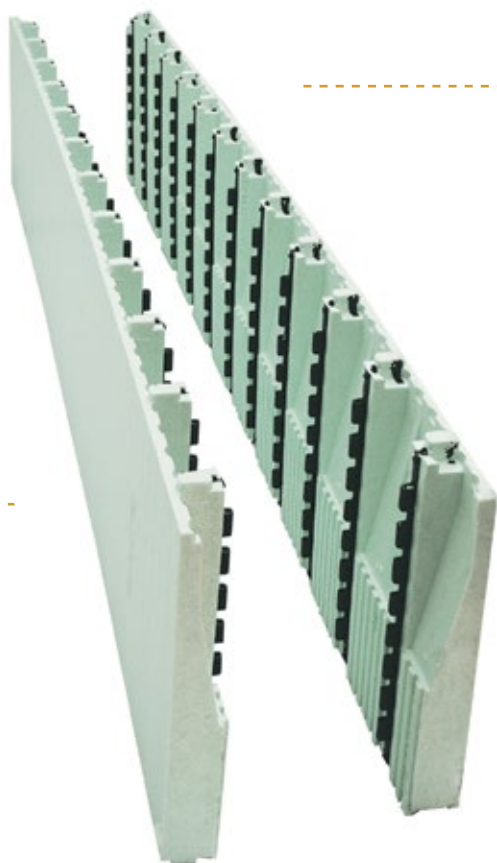

Close view of insert webs - available in 4"-12" (100-300mm) sizes

Unassembled Product Shown Above

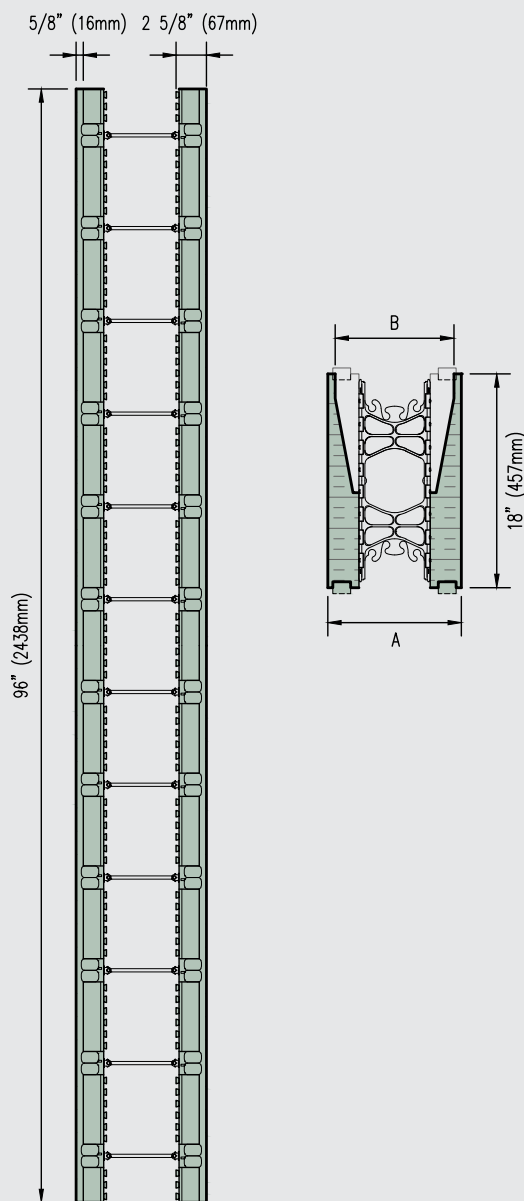

## Insert Webs (Ordered Separately)

### Small Box

Core Width	4" (100mm)	6" (150mm)	8" (200mm)	10" (250mm)	12" (300mm)
Qty./Box	100	100	100	100	100
Code #	WEB-4	WEB-6	WEB-8	WEB-10	WEB-12

### Large Box

Core Width	4" (100mm)	6" (150mm)	8" (200mm)	10" (250mm)	12" (300mm)
Qty./Box	957	655	465	388	295
Code #	WEB4	WEB6	WEB8	WEB10	WEB12

Core Width	4" (100mm)	6" (150mm)	8" (200mm)	10" (250mm)	12" (300mm)
Overall Width A	9 1/4" (235mm)	11 1/4" (286mm)	13 1/4" (337mm)	15 1/4" (387mm)	17 1/4" (438mm)
Overall Width B	8" (203mm)	10" (254mm)	12" (305mm)	14" (356mm)	16" (406mm)
Length - 96"	96" (2438mm)	96" (2438mm)	96" (2438mm)	96" (2438mm)	96" (2438mm)
Qty./Bundle	Includes: 6 Taper Top Panels				
Code #	TT-D	TT-D*	TT-D*	TT-D	TT-D
Web Qty. Req'd/Bundle	36	36	36	36	36

- Units come unassembled.
- \*Available assembled - 3 units/bundle (webs included): 6" (150mm) - TD96-6  
8" (200mm) - TD96-8
- Insert webs required per bundle - refer to web order chart on left.

Visit the Resource Center on NUDURA's website ([nudura.com/resource-center](http://nudura.com/resource-center)) for design details, BIM library, installation links & more.

Refer to pages 30-35 for all related product accessories & tools.  
For additional information visit [nudura.com](http://nudura.com) or call 866-468-6299.



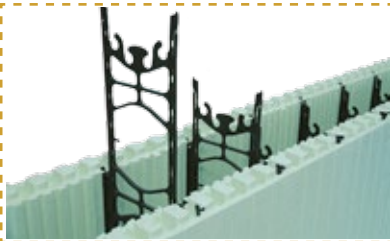
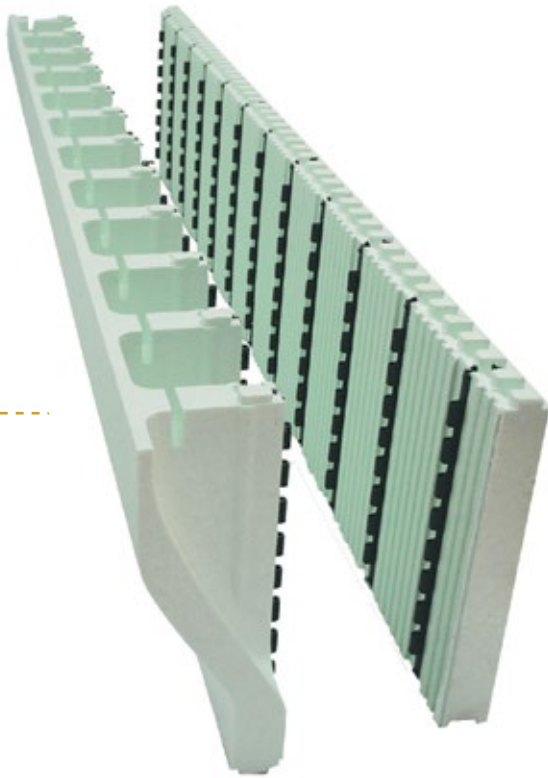

Close view of insert webs - available in 4"-12" (100-300mm) sizes

Unassembled Product Shown Above

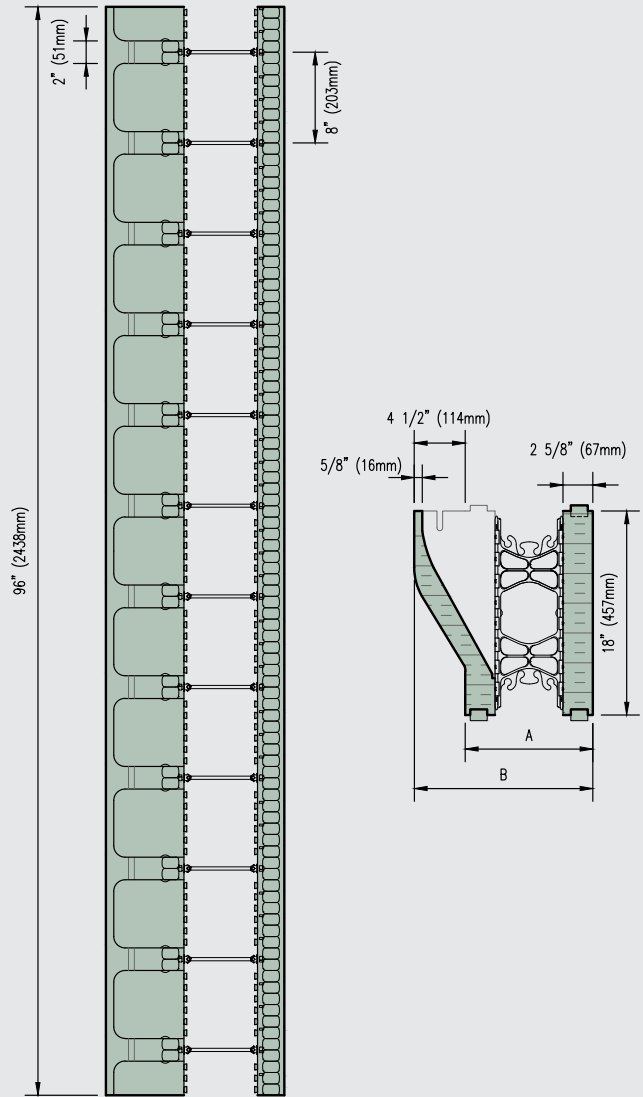

## Insert Webs (Ordered Separately)

### Small Box

Core Width	4" (100mm)	6" (150mm)	8" (200mm)	10" (250mm)	12" (300mm)
Qty/Box	100	100	100	100	100
Code #	WEB-4	WEB-6	WEB-8	WEB-10	WEB-12

### Large Box

Core Width	4" (100mm)	6" (150mm)	8" (200mm)	10" (250mm)	12" (300mm)
Qty/Box	957	655	465	388	295
Code #	WEB4	WEB6	WEB8	WEB10	WEB12

Visit the Resource Center on NUDURA's website ([nudura.com/resource-center](http://nudura.com/resource-center)) for design details, BIM library, installation links & more.

Refer to pages 30-35 for all related product accessories & tools. For additional information visit [nudura.com](http://nudura.com) or call 866-468-6299.

Core Width	4" (100mm)	6" (150mm)	8" (200mm)	10" (250mm)	12" (300mm)
Overall Width A	9 1/4" (235mm)	11 1/4" (286mm)	13 1/4" (337mm)	15 1/4" (387mm)	17 1/4" (438mm)
Overall Width B	13 3/4" (349mm)	15 3/4" (400mm)	17 3/4" (451mm)	19 3/4" (502mm)	21 3/4" (552mm)
48" requires one Brick Ledge Panel & one Standard Panel to assemble one form unit					
Length - 48"	48" (1219mm)	48" (1219mm)	48" (1219mm)	48" (1219mm)	48" (1219mm)
Qty/Bundle	Includes: 4 Brick Ledge Panels & 4 Standard Panels				
Code #	BRI-P	BRI-P	BRI-P	BRI-P	BRI-P
Web Qty. Req'd/Bundle	24	24	24	24	24
96" requires one Brick Ledge Panel & one Standard Panel to assemble one form unit					
Length - 96"	96" (2438mm)	96" (2438mm)	96" (2438mm)	96" (2438mm)	96" (2438mm)
Qty/Bundle	Includes: 2 Brick Ledge Panels & 2 Standard Panels				
Code #	BR96-P	BR96-P	BR96-P	BR96-P	BR96-P
Web Qty. Req'd/Bundle	24	24	24	24	24

Units come unassembled.

Insert webs required per bundle - refer to web order chart on left.

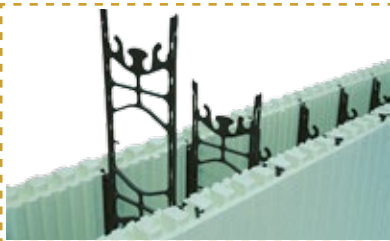
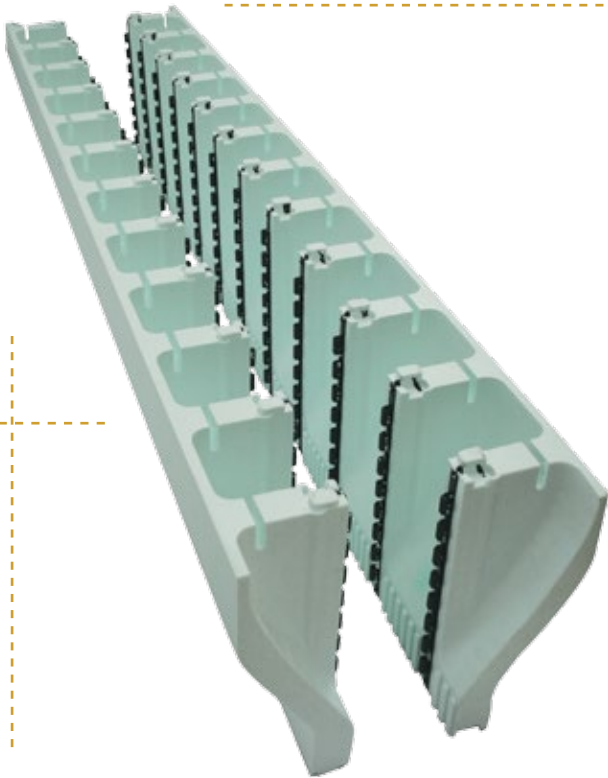

Close view of insert webs - available in 4"-12" (100-300mm) sizes

Unassembled Product Shown Above

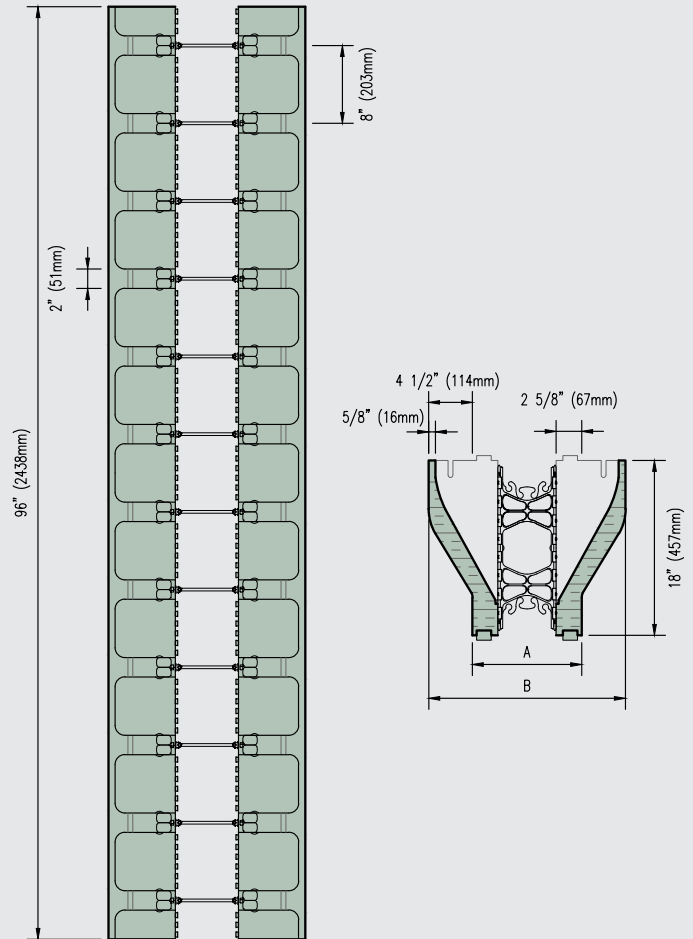

## Insert Webs (Ordered Separately)

### Small Box

Core Width	4" (100mm)	6" (150mm)	8" (200mm)	10" (250mm)	12" (300mm)
Qty./Box	100	100	100	100	100
Code #	WEB-4	WEB-6	WEB-8	WEB-10	WEB-12

### Large Box

Core Width	4" (100mm)	6" (150mm)	8" (200mm)	10" (250mm)	12" (300mm)
Qty./Box	957	655	465	388	295
Code #	WEB4	WEB6	WEB8	WEB10	WEB12

Visit the Resource Center on NUDURA's website ([nudura.com/resource-center](http://nudura.com/resource-center)) for design details, BIM library, installation links & more.

Refer to pages 30-35 for all related product accessories & tools. For additional information visit [nudura.com](http://nudura.com) or call 866-468-6299.

Core Width	4" (100mm)	6" (150mm)	8" (200mm)	10" (250mm)	12" (300mm)
Overall Width A	9 1/4" (235mm)	11 1/4" (286mm)	13 1/4" (337mm)	15 1/4" (387mm)	17 1/4" (438mm)
Overall Width B	18 1/4" (463mm)	20 1/4" (514mm)	22 1/4" (565mm)	24 1/4" (616mm)	26 1/4" (667mm)
48" requires two Brick Ledge Panels (BRI-P) to assemble one double sided unit					
Length - 48"	48" (1219mm)	48" (1219mm)	48" (1219mm)	48" (1219mm)	48" (1219mm)
Qty./Bundle	Includes: 4 Brick Ledge Panels & 4 Standard Panels				
Code #	BRI-P	BRI-P	BRI-P	BRI-P	BRI-P
Web Qty. Req'd/Bundle	24	24	24	24	24
96" requires two Brick Ledge Panels (BR96-P) to assemble one double sided unit					
Length - 96"	96" (2438mm)	96" (2438mm)	96" (2438mm)	96" (2438mm)	96" (2438mm)
Qty./Bundle	Includes: 2 Brick Ledge Panels & 2 Standard Panels				
Code #	BR96-P	BR96-P	BR96-P	BR96-P	BR96-P
Web Qty. Req'd/Bundle	24	24	24	24	24

- Units come unassembled.
- Insert webs required per bundle - refer to web order chart on left.

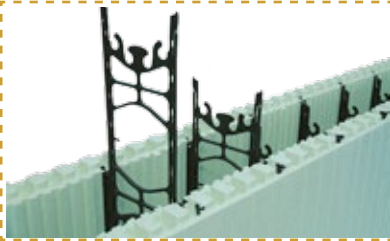
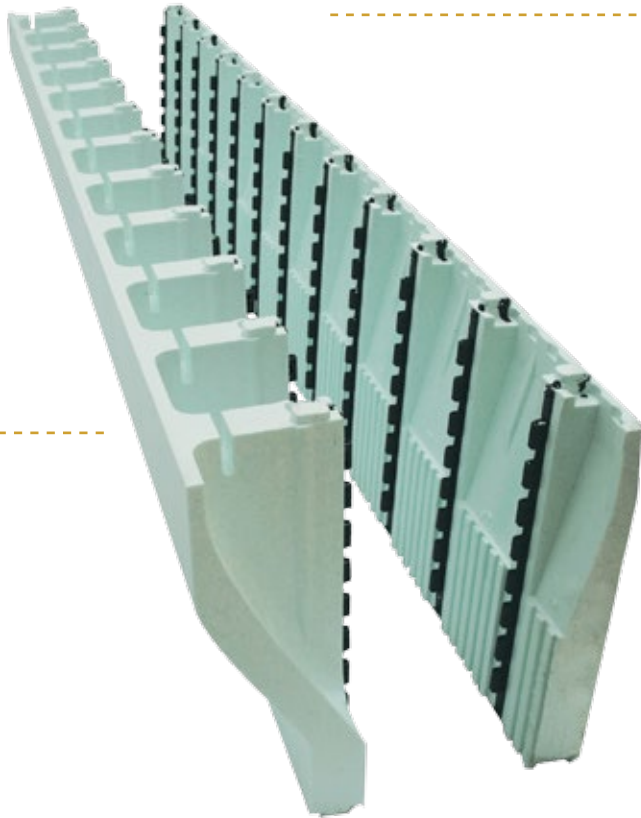

Close view of insert webs - available in 4"-12" (100-300mm) sizes

Unassembled Product Shown Above

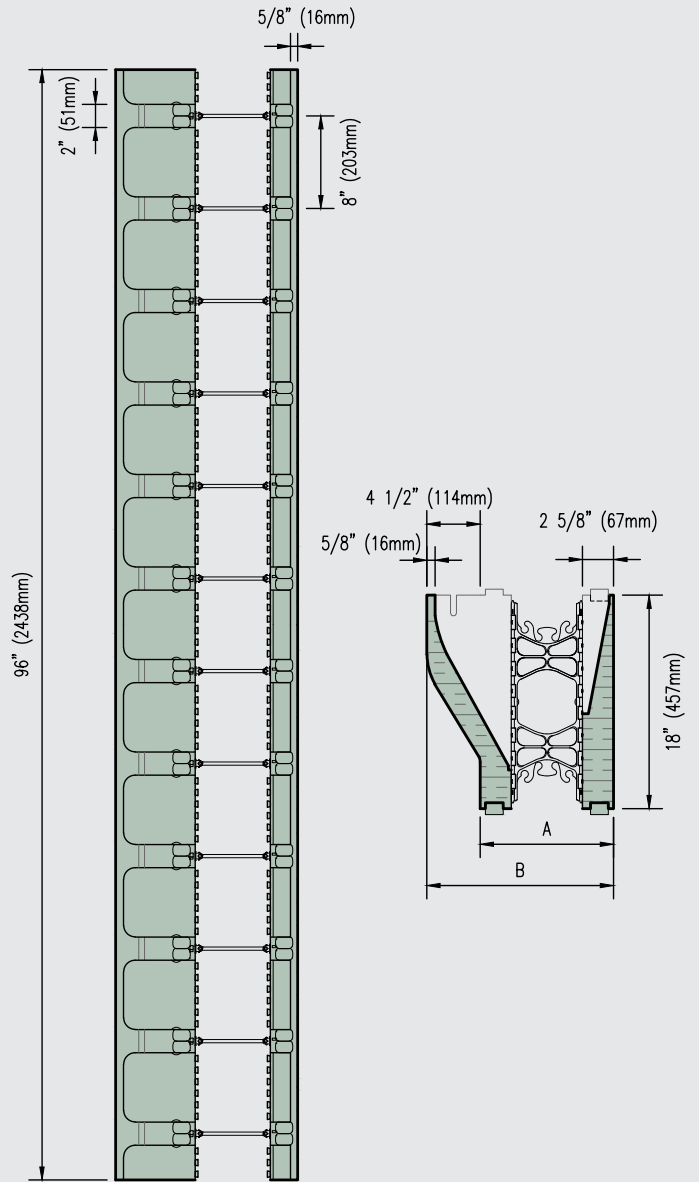

## Insert Webs (Ordered Separately)

### Small Box

Core Width	4" (100mm)	6" (150mm)	8" (200mm)	10" (250mm)	12" (300mm)
Qty./Box	100	100	100	100	100
Code #	WEB-4	WEB-6	WEB-8	WEB-10	WEB-12

### Large Box

Core Width	4" (100mm)	6" (150mm)	8" (200mm)	10" (250mm)	12" (300mm)
Qty./Box	957	655	465	388	295
Code #	WEB4	WEB6	WEB8	WEB10	WEB12

Visit the Resource Center on NUDURA's website ([nudura.com/resource-center](http://nudura.com/resource-center)) for design details, BIM library, installation links & more.

Refer to pages 30-35 for all related product accessories & tools. For additional information visit [nudura.com](http://nudura.com) or call 866-468-6299.

Core Width	4" (100mm)	6" (150mm)	8" (200mm)	10" (250mm)	12" (300mm)
Overall Width A	9 1/4" (235mm)	11 1/4" (286mm)	13 1/4" (337mm)	15 1/4" (387mm)	17 1/4" (438mm)
Overall Width B	13 3/4" (349mm)	15 3/4" (400mm)	17 3/4" (451mm)	19 3/4" (502mm)	21 3/4" (552mm)
96" requires two Brick Ledge Panels (BRI-P) & one Taper-Top Panel (TT96-P) to assemble one unit					
Length - 48"	48" (1219mm)	48" (1219mm)	48" (1219mm)	48" (1219mm)	48" (1219mm)
Qty./Bundle	Includes: 4 Brick Ledge Panels w/ 4 Standard Panels & 3 Taper Top Panels w/ 3 Standard Panels				
Code #	BRI-P & TT96-P	BRI-P & TT96-P	BRI-P & TT96-P	BRI-P & TT96-P	BRI-P & TT96-P
Web Qty. Req'd/Bundle	60	60	60	60	60
96" requires one Brick Ledge Panel (BR96-P) & one Taper Top Panel (TT96-P) to assemble one unit					
Length - 96"	96" (2438mm)	96" (2438mm)	96" (2438mm)	96" (2438mm)	96" (2438mm)
Qty./Bundle	Includes: 2 Brick Ledge Panels w/ 2 Standard Panels & 3 Taper Top Panels w/ 3 Standard Panels				
Code #	BR96-P & TT96-P	BR96-P & TT96-P	BR96-P & TT96-P	BR96-P & TT96-P	BR96-P & TT96-P
Web Qty. Req'd/Bundle	60	60	60	60	60

Units come unassembled.

Insert webs required per bundle - refer to web order chart on left.

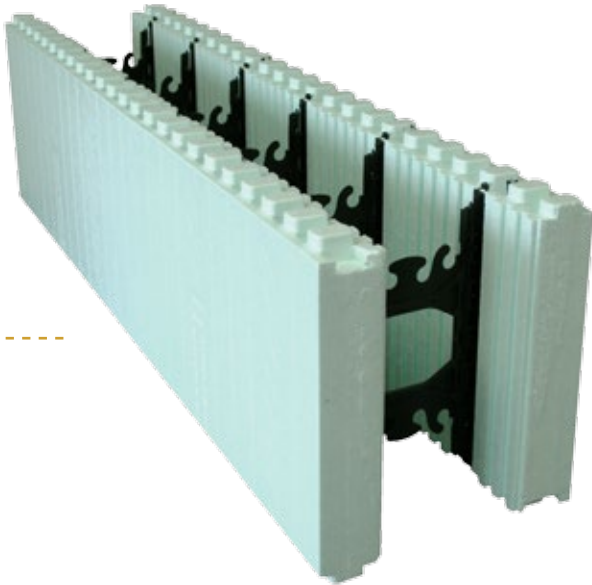

Close view of insert webs - available in 6"-12" (150-300mm) sizes

Product Shown Assembled Above

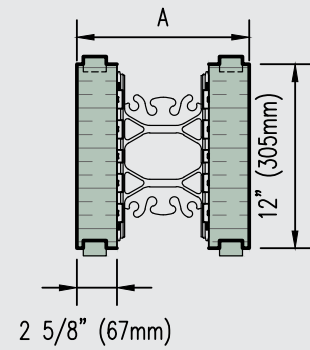
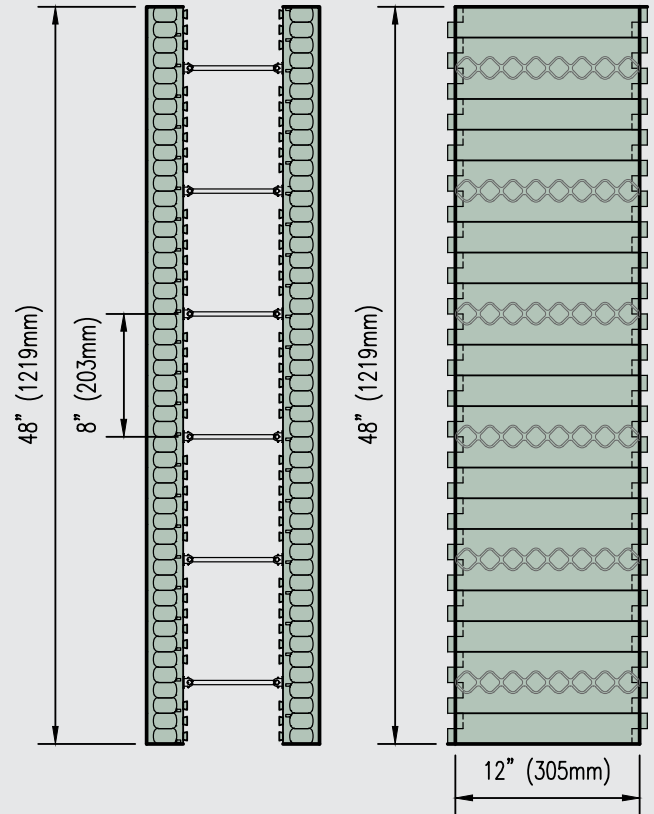

## Insert Webs (Ordered Separately)

Core Width	4" (100mm)	6" (150mm)	8" (200mm)	10" (250mm)	12" (300mm)
Qty./Box		120	120	84	84
Code #		OWEB-6	OWEB-8	OWEB10	OWEB12

Core Width	4" (100mm)	6" (150mm)	8" (200mm)	10" (250mm)	12" (300mm)
Length		48" (1219mm)	48" (1219mm)	48" (1219mm)	48" (1219mm)
Overall Width A		11 1/4" (286mm)	13 1/4" (337mm)	15 1/4" (387mm)	17 1/4" (438mm)
Height		12" (300mm)	12" (300mm)	12" (300mm)	12" (300mm)
Qty./Bundle	Includes: 12 Optimizer Panels (6 pairs per bundle)				
Code #		OP-PAN	OP-PAN	OP-PAN	OP-PAN
Web Qty. Red'd/Bundle		36	36	36	36

- Units come unassembled.
- Insert webs required per bundle - refer to web order chart on left.

Visit the Resource Center on NUDURA's website ([nudura.com/resource-center](http://nudura.com/resource-center)) for design details, BIM library, installation links & more.

Refer to pages 30-35 for all related product accessories & tools. For additional information visit [nudura.com](http://nudura.com) or call 866-468-6299.

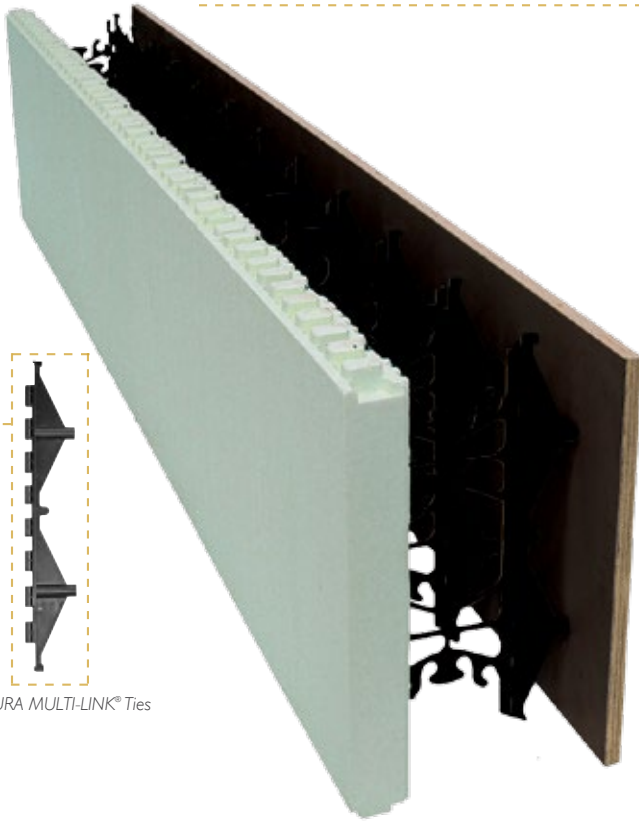

DURA MULTI-LINK® Ties



Metal Jig for One Series assembly

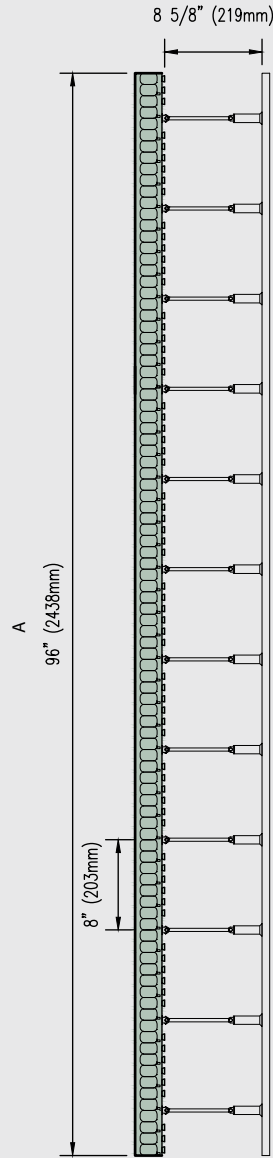

### 90° Corner Panel Options

#### 90° Corner EPS Panel Outside

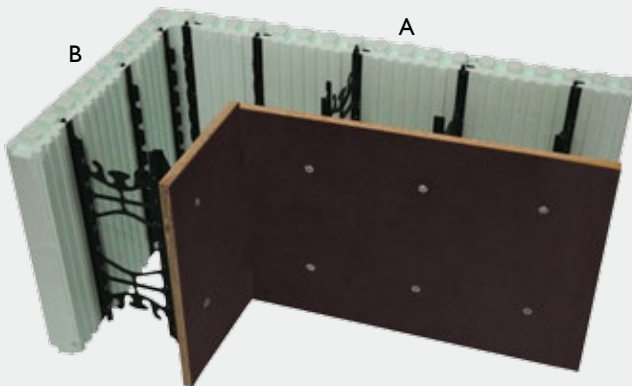

#### 90° Corner EPS Panel Inside

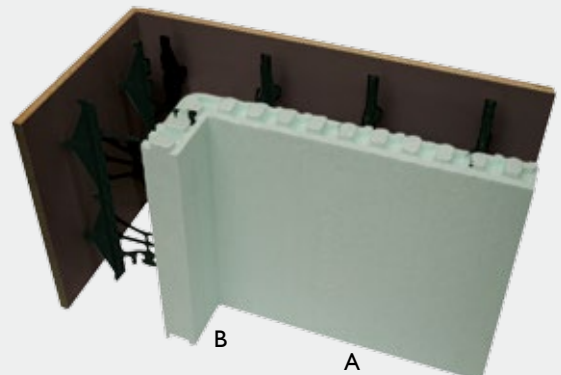

Note: Corner designation refers to EPS panel location.

Refer to pages 30-35 for all related product accessories & tools.  
For additional information visit [nudura.com](http://nudura.com) or call 866-468-6299.  
See next page for more information and codes to order the One Series.

Visit the Resource Center on NUDURA's website ([nudura.com/resource-center](http://nudura.com/resource-center)) for design details, BIM library, installation links & more.

**NOTE:**  
**To assemble a SINGLE One Series Form Unit you will require the following components:**

### STANDARD

- 1 x Standard EPS Panel
- 1 x Plywood Panel
- 24 x Screws
- 12 x DURA MULTI-LINK® Ties
- 12 x Insert Webs
- 1 x Jig

### 90° CORNER OUTSIDE

- 1 x 90° **Outside** EPS Panel
- 1 x Plywood Panel
- 8 x Screws
- 4 x DURA MULTI-LINK® Ties
- 4 x Insert Webs
- 1 x Jig

### 90° CORNER INSIDE

- 1 x 90° **Inside** EPS Panel
- 1 x Plywood Panel
- 12 x Screws
- 6 x DURA MULTI-LINK® Ties
- 4 x Insert Webs
- 1 x Jig

	Plywood*	Standard	90° Outside	90° Inside
Length A	96" (2438mm)	96" (2438mm)	37 5/8" (956mm)	20 3/8" (518mm)
Length B	-	-	21 5/8" (549mm)	4 3/8" (111mm)
Height	18" (457mm)	18" (457mm)	18" (457mm)	18" (457mm)
Qty/Bundle	1 Plywood Panel	6 Standard Panels	4 Panels	16 Panels
Code	PLYPAN	PANEL	90-OUT	S-TW-6
Web Qty Req/Bundle	-	72	16	64

Unassembled 45° Inside and Outside Panels available through special order only  
 \* Plywood panels must be cut on-site. Refer to brochure for instructions.

### Hex Head Screw with Steel Flat Washer

Size: #10 x 2.0" (50mm)  
 Qty./Pail: 1000  
 Code: SC-2.0

(2" (50mm) screws must be used – SC-2.0)

### DURA MULTI-LINK® Ties

Qty./Box: 96 pieces      Code: MULTI

### Jig

Metal Jig for One-Series Form assembly  
 Qty: 1 Jig      Code: ONEJIG

### Insert Webs (Ordered Separately)

Small Box

Core Width	4" (100mm)	6" (150mm)	8" (200mm)	10" (250mm)	12" (300mm)
Qty./Box	100	100	100	100	100
Code #	WEB-4	WEB-6	WEB-8	WEB-10	WEB-12

Large Box

Core Width	4" (100mm)	6" (150mm)	8" (200mm)	10" (250mm)	12" (300mm)
Qty./Box	957	655	465	388	295
Code #	WEB4	WEB6	WEB8	WEB10	WEB12

### Corner Connector

The corner connector is designed to securely connect two panels of plypan together at a 90° corner.

Length: 10' (3m)

Code: ONECB



Full length of connector not shown.



### Formply Inserts



Formply inserts are a component of the Plypan Panels and can now be purchased separately.

Qty./Box: 2,400 pieces allowing production of 100 plypan panels

Code: PLYINS

For more information watch our One Series video at [nudura.com/one](http://nudura.com/one)



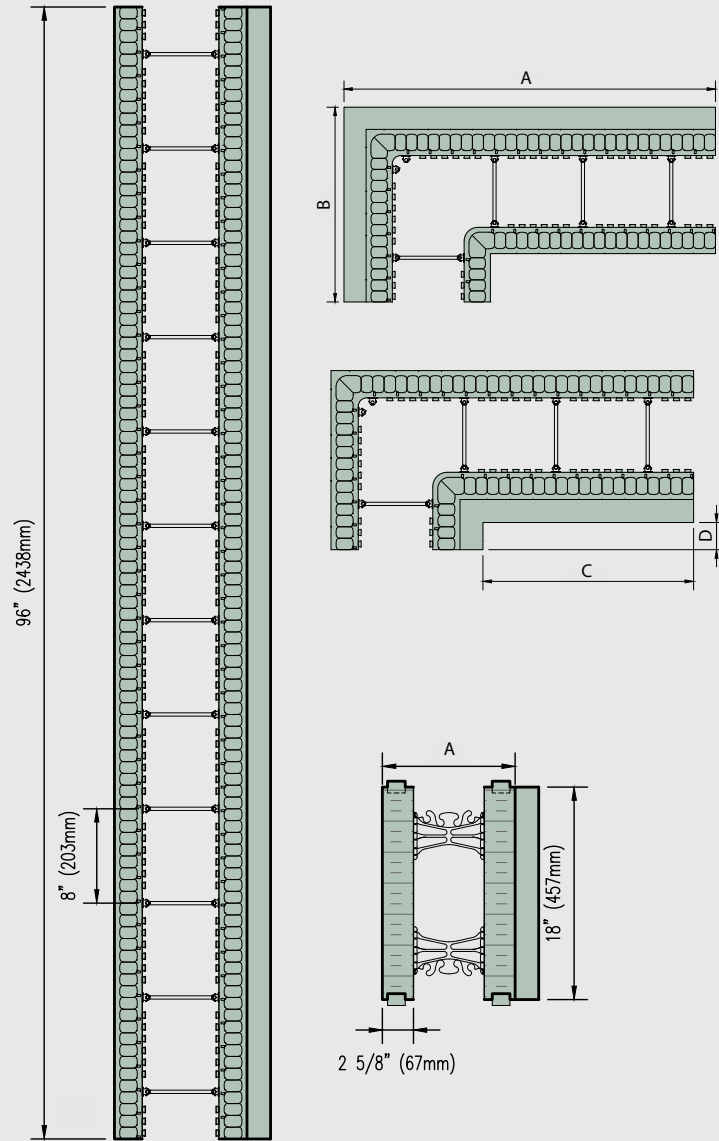
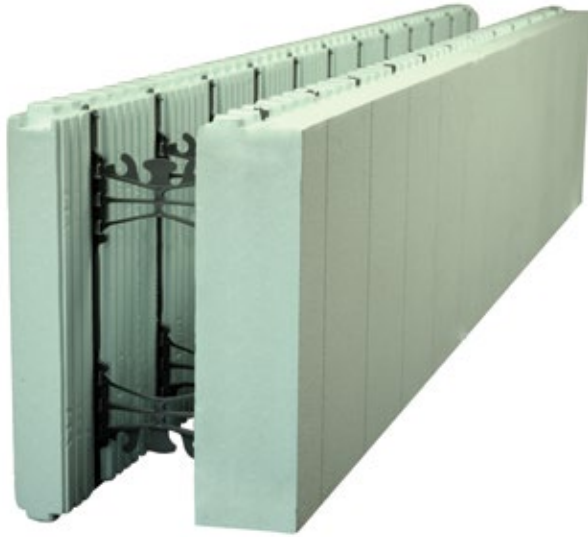

<b>Standard Form Unit</b> (Type 2 EPS Laminate on one side)				
Thickness	1" (25mm)	2" (50mm)	4" (100mm)	6" (150mm)
Length	96" (2438mm)	96" (2438mm)	96" (2438mm)	96" (2438mm)
Height	18" (457mm)	18" (457mm)	18" (457mm)	18" (457mm)
Qty./Bundle	3	3	3	3
Code	96-6P1	96-6P2	96-6P4	96-6P6

\*Other form units & core thicknesses available through special request.

<b>90° Form Unit - Outside (Long Side)</b> (Type 2 EPS Laminate on one side)				
Thickness	1" (25mm)	2" (50mm)	4" (100mm)	6" (150mm)
Length A	32 3/8" (813mm)	33 3/8" (854mm)	35 3/8" (905mm)	37 3/8" (956mm)
Length B	16 3/8" (422mm)	17 3/8" (448mm)	19 3/8" (498mm)	21 3/8" (550mm)
Height	18" (457mm)	18" (457mm)	18" (457mm)	18" (457mm)
Qty./Bundle	6	6	6	6
Code	906P1L	906P2L	906P4L	906P6L



1" (25mm) R-value - 28 U-value - 0.21	2" (50mm) R-value - 32 U-value - 0.18	4" (100mm) R-value - 40 U-value - 0.14	6" (150mm) R-value - 48 U-value - 0.12
---	---	--	--

<b>90° Form Unit - Inside (Short Side)</b> (Type 2 EPS Laminate on one side)				
Thickness	1" (25mm)	2" (50mm)	4" (100mm)	6" (150mm)
Length C	19 3/8" (492mm)	18 3/8" (467mm)	16 3/8" (416mm)	14 3/8" (365mm)
Length D	3 3/8" (86mm)	2 3/8" (60mm)	3/8" (10mm)	**
Height	18" (457mm)	18" (457mm)	18" (457mm)	18" (457mm)
Qty./Bundle	6	6	6	6
Code	906P1S	906P2S	906P4S	906P6S

Refer to pages 30-35 for all related product accessories & tools.  
For additional information visit nudura.com or call 866-468-6299.

\*\*On-site notching of EPS foam required.

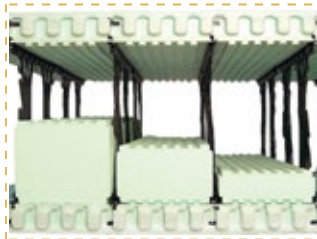
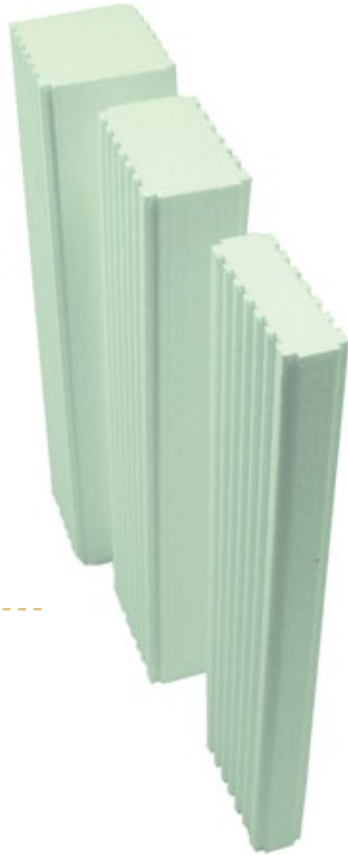

## Build your own R-Value

The NUDURA R-Value Inserts allow the ability to customize the desired amount of insulation needed to meet the specific requirements of any project. The inserts are available in 4 standard sizes: 1" (25mm), 2" (50mm), 4" (100mm) and 6" (150mm). Custom combinations can be created to provide further insulation value if desired and are compatible with all sizes of forms offered by NUDURA, with core sizes ranging from 4" (100mm) to 12" (300mm).



6" (150 mm) concrete core R-Value ratings based on exterior brick finish

### NUDURA Plus Series R-Value Inserts (EPS Foam Billet)

Thickness	1" (25mm)	2" (50mm)	4" (100mm)	6" (150mm)
Width	7 1/2" (190mm)	7 1/2" (190mm)	7 1/2" (190mm)	7 1/2" (190mm)
Height	32" (812mm)	32" (812mm)	32" (812mm)	32" (812mm)
Qty/Bdle	85	48	24	24
Code	INS-1	INS-2	INS-4	INS-6

Refer to pages 30-35 for all related product accessories & tools.  
For additional information visit [nudura.com](http://nudura.com) or call 866-468-6299.





## The easy insulation for radiant heat.



HYDROFOAM® is the ideal radiant floor insulation product for residential and commercial construction projects that increases comfort and energy efficiency. HYDROFOAM® maximizes radiant floor heating by ensuring the heat is dispersed evenly throughout the entire floor area, providing building occupants with a comfortable living and working environment. HYDROFOAM® offers installers a lightweight high density expanded polystyrene (EPS) product that increases installation speeds, is easily cut to meet any angle or radius while providing up to R-16 insulation value.

Installation is fast and easy compared to traditional foam insulation. The 4' x 4' (1.2m x 1.2m) boards, available in two thickness, are easily installed with an overlapping interlock on all four sides, ensuring the boards are locked in place during installation. HYDROFOAM® utilizes a 360° multidirectional friction fit anchor system that eliminates the need for wire mesh. Radiant heat piping is easily stepped into place in any direction required.

### Product Highlights:

- Insulation under the concrete slab
- 4' x 4' (1.2m x 1.2m) molded boards
- Only 4" (100mm) from base to nubs
- Available thicknesses: 2 1/2" (64mm) - R10 (RSI 1.76, U-value 0.568)  
As a special order: 4" (100mm) - R16 (RSI 2.84)
- Multi-directional anchoring for 1/2" (13mm) pipes
- Compatible with 1/2" (13mm) diameter and 5/8" (16mm) diameter radiant tubing
- Radiant tube spacing is based on 3" (76mm) increments
- Shiplap/interlocking on all 4 sides
- Eco-friendly. No CFC's or HCFC's
- 100% recyclable
- Resistant to water and moisture
- Can contribute to points under LEED® NC programs

Sheet Thickness	2 1/2" (64mm)	4" (100mm)
Sheet Size	4' x 4' (1.2m x 1.2m)	4' x 4' (1.2m x 1.2m)
Qty./Bundle	10	6
Code #	RHFL	RHFL-4

For more information download our [Technical Data Sheet on nudura.com](#)



Watch our HYDROFOAM® Installation Video at [nudura.com/hydrofoam](http://nudura.com/hydrofoam).

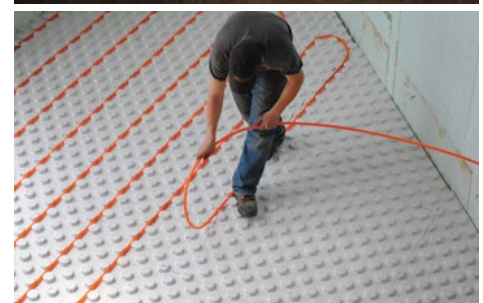

# RetroFit

NUDURA Insulation Technology



## Easy Installation. Superior Performance.



NUDURA RetroFit Insulation Technology is an easy-to-use insulation solution for finishing basements or insulating interior or exterior block walls. Installation is fast and effortless, compared to conventional multi-step finishing methods. The NUDURA RetroFit Insulation Technology insulates and creates fastening points in one simple step.

Simply attach NUDURA's standard 4' x 8' (1.2m x 2.4m) sheets to the wall using the embedded fastening strip and a concrete screw. NUDURA RetroFit Insulation Technology panels fit seamlessly together with a shiplap system, electrical installation is easily completed, and drywall or Gypsum Board is attached using the 2 1/2" (64mm) fastening strip located on 16" (400mm) centers.

When installed, NUDURA RetroFit Insulation Technology provides insulation performance ratings up to R-14.8 resulting in greater energy efficiency and comfort to any home or commercial structure.

### Product Highlights:

- Provides up to R-14.8 of insulation
- Moisture resistant
- No VOC's, CFC's or HCFC's
- Available in 4' x 8' (1.2m x 2.4m) sheets and thicknesses of 2 5/8" (67mm), 3 1/2" (89mm), 3 7/8" (98mm)
- Performance ratings up to R-14.8 (RSI 2.61 & U-Value 0.384 w/m<sup>2</sup>•k)
- Available with wood or polystyrene fastening strips
- Made of EPS (Expanded Polystyrene) making it lightweight and easy to cut
- Simple to install with embedded 2 1/2" (64mm) fastening strip located on 16" (400mm) centers
- Panels easily fit together with a shiplap system to eliminate thermal bridging
- Insulation for basement walls or interior, exterior block walls



Sheet Thickness	2 5/8" (67mm)	3 1/2" (89mm)	3 7/8" (98mm)
Sheet Size	48" x 96" (1219 x 2438mm)	48" x 96" (1219 x 2438mm)	48" x 96" (1219 x 2438mm)
Qty./Bundle	6	4	4
Strapping	Wood   Polystyrene	Wood   Polystyrene	Wood   Polystyrene
Code #	P9-050   P9-055	P9-040   P9-045	P9-031   P9-035

#### 5" (127mm) Concrete Screws

Qty./Pail: 300 screws  
Code # SC-CSL

Qty./Jar: 50 screws  
Code # SC-CS

#### 6" (152mm) Concrete Screws

Qty./Pail: 50 screws  
Code # SC-CS6



For more information download our [Technical Data Sheet on nudura.com](#)



Watch our RetroFit Installation Video at [nudura.com/retrofit](http://nudura.com/retrofit).

# Ceiling & Floor Technology



## NUDURA Ceiling Technology



Sheet Thickness	2 5/8" (67mm)	3 1/2" (89mm)	3 7/8" (98mm)
Sheet Size	48" x 96" (1219 x 2438mm)	48" x 96" (1219 x 2438mm)	48" x 96" (1219 x 2438mm)
Wood Strapping	Yes	Yes	Yes
Qty./Bundle	6	4	4
Code #	P9-050	P9-040	P9-031



#10 Screws	4" (102mm)	5" (127mm)	6" (152mm)
Qty./Box	500	500	500
Code #	SC-4.0	SC-5.0	SC-6.0

### Product Highlights:

- Reduces air infiltration efficiently
- Water and humidity resistant
- Used in a double layer, it further reduces thermal bridging, increasing energy efficiency and comfort
- Superior performance & user friendly
- Eco-friendly Expanded Polystyrene (EPS) - does not contain CFC's or HCFC's
- 100% recyclable
- Embedded wood or high impact polystyrene (limited quantities available) fastening strips

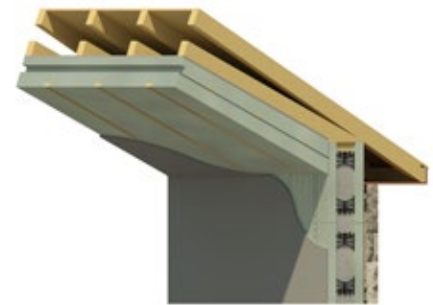

## NUDURA Floor Technology



Type 2 - Pink/Green	Pink - 1 1/4" (32mm) Overlap	Green - 1 7/8" (48mm) T&G	Pink - 2 1/2" (64mm) T&G
Size	24" x 96" (610x2438mm)	24" x 96" (610x2438mm)	24" x 96" (610x2438mm)
Qty./Bundle	15	10	7
Code #	P2-435	P2-445	P2-455
Type 3 - Grey	N/A	Grey - 1 7/8" (48mm) T&G	Grey - 2 1/2" (64mm) T&G
Size	-	24" x 96" (610x2438mm)	24" x 96" (610x2438mm)
Qty./Bundle	-	8	6
Code #	-	P3-443	P3-453

The floor of a building is often the most ignored surface when it comes to insulation. With changing energy codes, under slab insulation is becoming mandatory for code compliance in some regions. Complete the building envelope and insulate with NUDURA Floor Technology for increased comfort and energy efficiency.

### Product Highlights:

- A cost effective layer of protection against heat transfer to the ground
- An effective base for radiant floor heating
- Expanded Polystyrene (EPS) does not contain CFC's or HCFC's - 100% recyclable

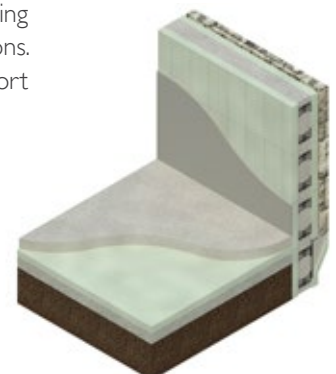



## Energy Savings. Quick Installation.

Quality products that feature innovation to make the building process easier and faster is crucial to our customers. We believe driving innovation and changing the status quo allows us to provide the most innovative line of insulation products on the market. The NOVOFOIL® is a non-toxic reflective vapor-barrier insulation board offering builders a lightweight and easy to handle product which provides faster installation.

For home owners, it offers a higher thermal resistance, better sealing and overall comfort. At the core of this innovative line is a laminated vapor-barrier membrane which allows for a stable and uniform indoor temperature year round. For builders, the NOVOFOIL® is ideal for interior walls, ceilings and interior foundations walls and provides better installation with a 1/2" (13mm) shiplap on the board. This innovative board features energy savings through the elimination of thermal bridging and permanent insulation value. The end result is increased comfort.

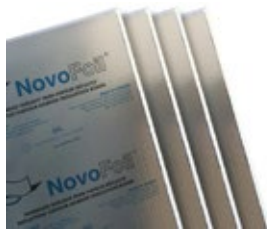

### Product Highlights:

- Insulation for interior walls, ceiling and foundation walls
- 4' x 8' (1.2m x 2.4m) or 4' x 8' 4" (1.2m x 2.6m) laminated vapor-barrier membrane on one side
- Benchmarks at 8" (203mm) intervals printed on the membrane
- 1/2" (13mm) shiplapped on 2 sides (for thicknesses of 1" (25mm) or more)
- Eco-friendly. No CFC's or HCFC's
- Contains recycled material
- Resistant to water and moisture that may be the primary cause of mildew formation
- Non-toxic, contains 98% air and 2% materials
- Can contribute to points under LEED® NC programs



*According to project requirements, boards can be cut to the desired thickness before laminating with the aluminum vapor-barrier membrane.*

For more information download our [Technical Data Sheet on nudura.com/resource-center/brochures](http://nudura.com/resource-center/brochures)

CODE	PRODUCT DIMENSIONS	QTY/BDL
NFOIL0.5-97	1/2" x 48" x 97" (13mm x 1219mm x 2464mm)	60
NFOIL1-96	1" x 48" x 96" (25mm x 1219mm x 2438mm)	30
NFOIL2-96	2 1/8" x 48" x 96" (54mm x 1219mm x 2438mm)	14
NFOIL3-96	3" x 48" x 96" (76mm x 1219mm x 2438mm)	10
NFOIL3-100	3" x 48" x 100" (76mm x 1219mm x 2540mm)	10



## Increased Comfort. Efficient Installation.

Quality products that feature innovation to make the building process easier and faster is crucial to our customers. We believe driving innovation and changing the status quo allows us to provide the most innovative line of Insulation products on the market. The AIRCLAD® is a non-toxic air-barrier insulation board offering builders a lightweight and easy to handle product which provides faster installation.

For home owners, it offers energy efficiency and overall comfort. At the core of this innovative line is a laminated air-barrier membrane which allows for a stable and uniform indoor temperature year round. For builders, the AIRCLAD® is ideal for exterior walls and provides quick installation with 36 square feet surface coverage area. This innovative board features energy savings through high-density expanded polystyrene board. The end result is increased comfort.



### Product Highlights:

- Insulation for exterior walls (residential, commercial, industrial and institutional construction)
- 4' x 8' (1.2m x 2.4m) or 4' x 9' (1.2m x 2.7m) laminated air-barrier membrane on one side
- Benchmarks at 8" (203mm) intervals printed on the membrane
- ½" (13mm) shiplapped on 2 sides
- Eco-friendly. No CFC's or HCFC's
- Contains recycled material
- Resistant to water and moisture that may be the primary cause of mildew formation
- Non-toxic, contains 98% air and 2% materials
- Can contribute to points under LEED® NC programs



*According to project requirements, boards can be cut to the desired thickness before laminating with the air-barrier membrane.*

For more information download our [Technical Data Sheet](http://nudura.com/resource-center/brochures) on nudura.com/resource-center/brochures

CODE	PRODUCT DIMENSIONS	QTY/BDL
ACLAD I-96	1" x 48" x 96" (25mm x 1219mm x 2438mm)	30
ACLAD I.5-96	1 ½" x 48" x 96" (38mm x 1219mm x 2438mm)	20
ACLAD I-108	1" x 48" x 108" (25mm x 1219mm x 2743mm)	30

## Brick Ledge Extension & 6" (152mm) Screw & Plastic Washer

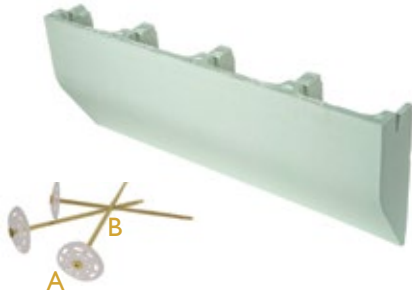

Length	32" (813mm)
Width	4 1/2" (114mm)
Height	13" (330mm)
Qty./Bundle	14
Code #	BRICK

**Brick Ledge Extensions** are used for supporting standard brick or stone veneer finishes, when constructing brick ledges at corners, and can be installed to meet any elevation change or slope.



### A. Plastic Washer

Qty./Box	250
Code #	SC-PW

### B. 6" (152mm) Screw

Qty./Box	500
Code #	SC-6.0

**Screw & Plastic Washer** to be used to attach the Brick Ledge Extension to the form wall or to attach additional foam panels for increased insulation to a building.

## End Cap (with Fastening Strip)



Width	4" (100mm)	6" (150mm)	8" (200mm)	10" (250mm)	12" (300mm)
Height	18" (457mm)	18" (457mm)	18" (457mm)	18" (457mm)	18" (457mm)
EPS Thickness	2 3/8" (67mm)	2 3/8" (67mm)	2 3/8" (67mm)	2 3/8" (67mm)	2 3/8" (67mm)
Qty./Box	57	40	30	35	30
Code #	ECF-4	ECF-6	ECF-8	ECF10	ECF12

**End Cap (with Fastening Strip)** can be used to terminate a wall. It can also be used as a buck material for windows.

## Height Adjuster (with Fastening Strip) & Height Adjuster Tie



Length	32" (813mm)
Height	3" (76mm)
Qty./Bundle	80
Code #	HADJ-F

The **Height Adjuster (with Fastening Strip)** combined with the **Height Adjuster Tie** can increase the height of a wall by 3" (75mm) increments. The Height Adjuster ties allow the foam panels to be connected together. Site assembly required.

**Height Adjuster Tie** One HADJ-F Bundle requires 160 Height Adjuster Ties

Core Width	4" (100mm)	6" (150mm)	8" (200mm)	10" (250mm)	12" (300mm)
Qty./Box	100	100	100	100	80
Code #	HA-T-4	HA-T-6	HA-T-8	HA-T10	HA-T12

## FORM-LOCK

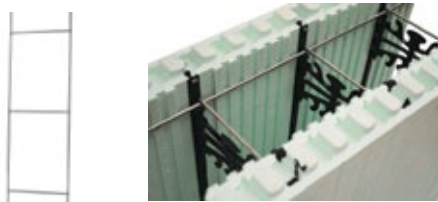

Full length of FORM-LOCK not shown.

Available for 6" - 12" (150 - 300mm) Standard Forms only.

Core Width	6" (150mm)	8" (200mm)	10" (250mm)	12" (300mm)
Length	10' (3m)	10' (3m)	10' (3m)	10' (3m)
Qty./Bundle	10 pcs	10 pcs	10 pcs	10 pcs
Code #	BLOK06	BLOK08	BLOK10	BLOK12

**FORM-LOCK** is used to maintain wall straightness. Other uses include wall alignment for vertical stack joints. Each bundle has 100' (30m) of FORM-LOCK.

## Lintel/Cavity Closure

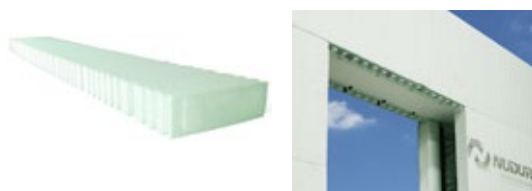

The **Lintel Insulation Insert** provides installers a product that provides insulation above and below the window to minimize thermal bridging. The NUDURA Lintel Insert is available in a standard 2" (50mm) thickness.

Core Width	4" (100mm)	6" (150mm)	8" (200mm)	10" (250mm)	12" (300mm)
Qty./Box	84	60	48	36	36
Code #	LINT04	LINT06	LINT08	LINT10	LINT12

## 4-Way Web Connector

Qty./Box	100 PCS
Code #	4XWEBC

The 4-Way Web Connector allows two or more insert webs to be connected together and used with the panel system to create wider form sizes. It also can be used to create forms of different shapes and sizes. Increased design flexibility.



## ICF Hanger System (Formerly; Multi Purpose Anchor Hanger System)

### A. ICF Hanger Insert Plate

Qty./Box	50 PCS
Code #	ICFHIP

### B. Stamped Bearing Bracket

(\*12 Screws Incl. - Box of 170)

Qty./Box	25 PCS
Code #	ICFSBB

The ICF Hanger System is used for connecting wood floor joists or for a wood roof connection system. An inexpensive, yet labor friendly connection system.

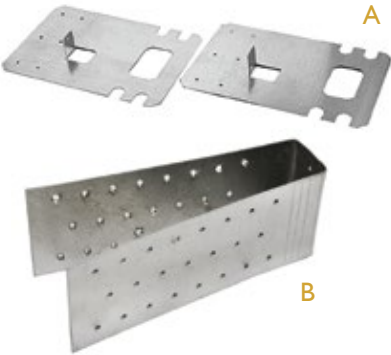

## 45° ICF Hanger Insert Plate

1 1/4" (32mm) x 3 1/2" (89mm)

Qty./Box	20 PCS	*12 Screws Incl. - Box of 170
Code #	HIP-45	

The 45° ICF Hanger Insert Plate is the same as the standard ICF Hanger Insert Plate but gives a solid floor connection for inside 90° corners as well as 45° corner connections. The 45° ICF Hanger Insert Plate is used in conjunction with the Stamped Bearing Bracket.



## Retrofit Bracket

Qty./Box	12 PCS	Lag Bolts not included.
Code #	ICFRFB	

The Retrofit Bracket is used in conjunction with the Stamped Bearing Bracket as an after thought for attachment to the concrete. This corrects mistakes made from improper installation of the ICF Hanger Insert Plates.

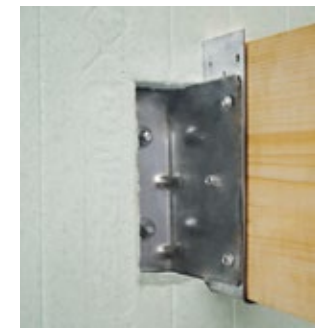

## Transition Bracket

Qty./Box	100 PCS
Code #	TRA-BR

The Transition Bracket allows two different form widths to be connected together. Primary use is to create a ledge to support brick or a floor system.

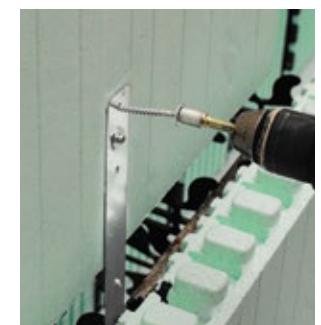

## 8 5/8" (219mm) Vertical Joint Clip

Qty./Box	200 PCS
Code #	VJC

The Vertical Joint Clip is designed to connect the form together at the vertical joints. It replaces having to tie wire or tape forms together while providing a solid connection using minimal amount of labor to install.

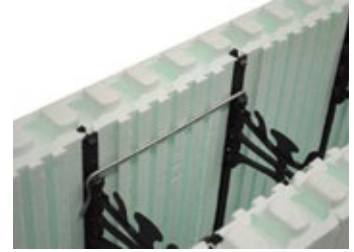

## Hex Head Screw with Steel Flat Washer

Size	#10 x 2" (50mm)	#10 x 2.5" (64mm)	#10 x 3" (76mm)
Qty./Box	1000 PCS	1000 PCS	1000 PCS
Code #	SC-2.0	SC-2.5	SC-3.0

The #10 screw can be used to connect the NUDURA Alignment System to the forms. Other uses include attachment of strapping or buck material to concrete. Available in 2" (50mm), 2 1/2" (64mm), and 3" (76mm) lengths. Two 1/4" (6mm) nut drivers included per pail.



## 10 Piece Bit Kit

Contact your local distributor for more information on how to order.	Qty./Box	12 KITS
	Code #	BITKIT

Ten piece kits include five 1/4" magnetic nutsetters which can be used with any of NUDURA's Hex Head Screws with Steel Flat Washers, as well as five #2 red square driver bits. The durable plastic case keeps all the bits together in one convenient spot and limits trying to find drivers bits on site during construction.



## V-Clip

Qty./Box	250 PCS
Code #	VCLIP

The V-Clip is used to connect a NUDURA panel to a concrete floor. It allows the contractor to support the panel without additional materials used on the outside of the wall.

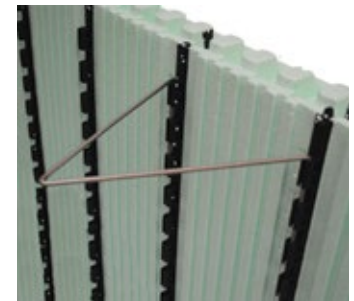

## Easy Buck - 10' (3m) Long

Qty./Bundle	10 CAPS
Code #	WBUCK

The Easy Buck is used for window and door jams and allows nominal sized lumber to fit between the Expanded Polystyrene (EPS) panels. Primary uses are for doors and windows. Each bundle contains 100' (30m) of Easy Buck.



Product may be different than shown. Product subject to change.







### Brick Ties (Galvanized Steel)

Qty./Box	100 PCS
Code #	BRKTG

Cast-In Place Brick Tie and Pintle. – Enables solid anchorage of veneer masonry through exterior foam to concrete core; tested to meet ASTM D754 (USA) and CSA-A370 (CAN) std. requirements for masonry anchors.

### Brick Ties (Stainless Steel)

Qty./Box	100 PCS
Code #	BRKTSS

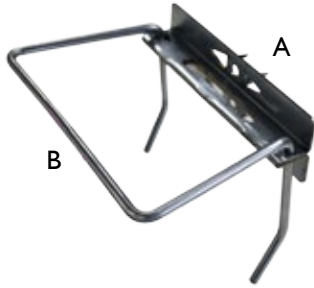

### Surface Mount Ties (A)

Qty./Box	100 PCS
Code #	SBRKTG

### Pintle (B)

Qty./Box	100 PCS
Code #	PINTLE

Surface Mount Tie and Pintle. – Designed to be fastened with two NUDURA Hex head Screws anywhere on the NUDURA fastening strip. This tie will accept NUDURA Pintels and other smaller dimension pintels.



### Fiber Tape - 1" x 200' (24mm x 55m)

Qty./Box	36 PCS
Code #	TAPE

Fiber Tape is used to provide additional EPS support for field cut forms that have more than 4" (100mm) of EPS extending past the last web, brick ledge forms in corner conditions, and radius panel.



### 4" Protective Tape - 4" x 260' (96mm x 66m)

Qty./Box	18 PCS
Code #	TAPE-4

The 4" Protective Tape is used for covering the interlock at the top of a wall to prevent concrete from flowing into the sockets. Protective Tape can also be used as an air barrier tape.



### 4" Heavy Duty Tape - 4" x 260' (96mm x 66m)

Qty./Box	24 PCS
Code #	TAP4HD

The 4" Heavy Duty Tape is used for covering the interlock at the top of a wall to prevent concrete from flowing into the sockets. Heavy Duty Tape can also be used as an air barrier tape.





## Parging Mix - Coverage of 75 sq. ft. (7m<sup>2</sup>)

Qty.	1 BAG
Code #	PARG

The parge mix is a dry cementitious product that is used to cover exposed EPS that is not covered by an exterior finish. Used in conjunction with Fiber Mesh.



## Fiber Mesh - Coverage of 475 sq. ft. (44m<sup>2</sup>)

Qty.	1 ROLL
Code #	MESH

The fiber mesh gets embedded into the parge coat to give it strength.



## NUDURA Low Expansion Foam - 24oz (680g)

Qty./Box	12 PCS
Code #	FOAM

The Low Expansion Foam is compatible with NUDURA's Expanded Polystyrene (EPS) foam and can be used for a number of different tasks on site including foaming the forms to the slab or footing, between vertical joints, securing service penetrations, and as insulation around openings.



## Foam Gun (Metal Handle)

Qty.	1 GUN
Code #	GUN-M

The metal handle Foam Gun is compatible with the NUDURA Low Expansion Foam 24oz (680g) cans. The NUDURA Low Expansion Foam can be used for a number of different tasks on site.



## Foam Gun Cleaner - 21oz (340g)

Qty./Box	12 PCS
Code #	FOAM-C

The Foam Gun Cleaner is used to clean the internal chamber of the foam gun from any hardened foam. Also used on the external surfaces for cleaning the guns.



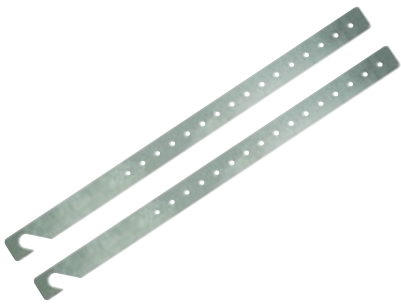

## T-Form Support Strap

Qty./Bundle	30 PCS
Code #	TSTRAP

Created to aid in installation and support on-site cut T-connections. The steel straps are designed to hook over the internal reinforcing on the main wall of a T-Wall connection and be secured to the fastening strips of the "T" portion of the wall.



## Folding Saw

Qty.	1 SAW
Code #	SAW

A great combination of cutting power and comfort, whether you're cutting overhand or making undercuts in the form. The soft grip handle provides a secure grip and the saw folds and locks for space-saving storage and safe transportation.



## Waterproofing Membrane - 225 sq. ft. (21m<sup>2</sup>)

### A. Summer Grade

Qty.	1 ROLL
Code #	WPROF

### B. Winter Grade

Qty.	1 ROLL
Code #	WPROF2

The Peel & Stick Waterproofing Membrane is used for below grade damp proofing of the NUDURA walls. Other uses for the Waterproofing Membrane include drain flashings around window and door openings and brick ledge through wall flashings.

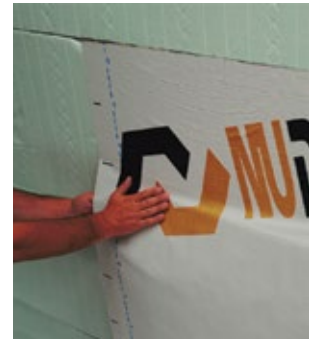

## Membrane Primer

Qty.	1 PAIL
Code #	WPRIME

The Membrane Primer is designed for use with NUDURA's self-adhesive waterproof membranes. This polymer emulsion-based primer is available in a 19L (5 gallon) pail, with a coverage of approximately 1020 sq. ft. (95m<sup>2</sup>) of wall area per pail. The NUDURA Membrane primer can help improve adhesion of NUDURA's Waterproofing Membrane in specific areas.

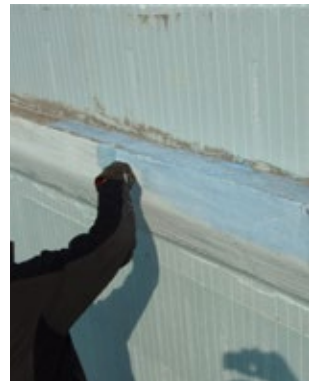

## Rebar Bender Cutter

Qty.	1 Bender/Cutter
Code #	RBC

The Rebar Bender Cutter is used for cutting and bending reinforcing steel used in the NUDURA wall system. Comes with two cutting heads that will cut up to #5 (15M) reinforcing steel. The rollers used for bending the steel are capable of handling up to a #5 (15M) bar.



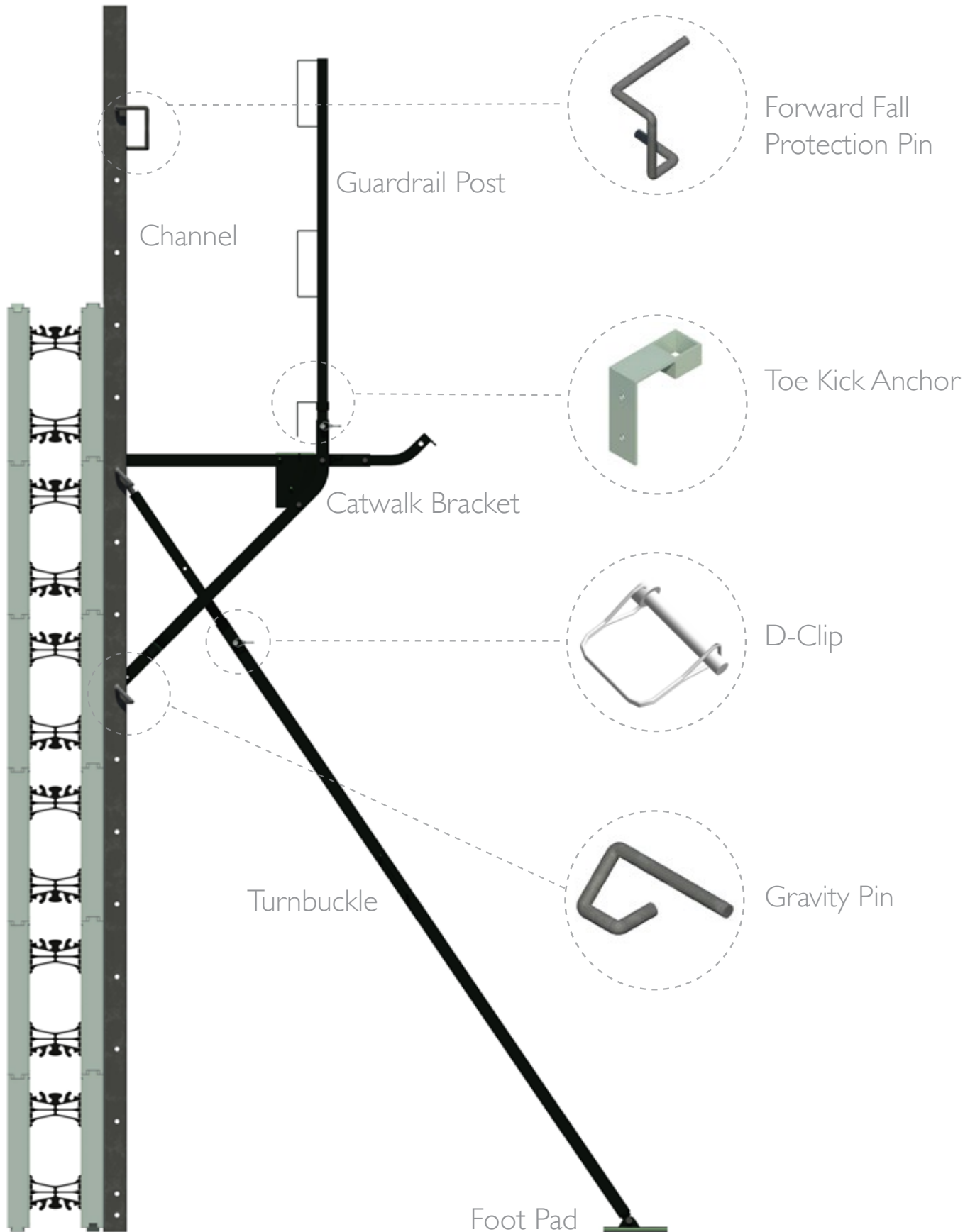

Diagram above illustrates both Square & Round Tube Bracing. For reference only.

## Square Tube Bracing - No Wall Channels

Includes	20 Guardrail Post 20 Catwalk Brackets 20 Turnbuckles 40 Gravity Pins
Code #	BRAC-L

Packaged on a wooden skid.

\*\*Metal Bracing Rack available to order separately.

*Wall Channels ordered separately. See below.*

## Square Tube Bracing w/12' Wall Channels

Includes	20 - 12' Wall Channels 20 Guardrail Post 20 Catwalk Brackets 20 Turnbuckles 40 Gravity Pins
Code #	BST12R*

\*\*Packaged in Metal Bracing Rack

## Square Tube Bracing w/10' Wall Channels

Includes	20 - 10' Wall Channels 20 Guardrail Post 20 Catwalk Brackets 20 Turnbuckles 40 Gravity Pins
Code #	BST10R

\*\*Packaged in Metal Bracing Rack

### Wall Channels (Bracing Not Included)

8' (2m)	CHA-8*
10' (3m)	CHA-10
12' (4m)	CHA-12
Channels/Bdl	20

## Round Tube Bracing w/10' Wall Channels

Includes	20 - 10' Wall Channels 20 Guardrail Post 20 Catwalk Brackets 20 Turnbuckles 40 Gravity Pins
Code #	BRT10R*

\*\*Packaged in Metal Bracing Rack

## Round Tube Bracing w/12' Wall Channels

Includes	20 - 12' Wall Channels 20 Guardrail Post 20 Catwalk Brackets 20 Turnbuckles 40 Gravity Pins
Code #	BRT12R*

\*\*Packaged in Metal Bracing Rack

## D Clip

Includes	100/Box
Code #	D-CLIP

## Gravity Pins - 6" (152mm)

Includes	50/Box
Code #	G-PINS

## Forward Fall Protection Pin

Includes	40/Box
Code #	FFGPIN

## Toe Kick Anchor

Includes	40/Box
Code #	TCLAMP

\*Special Order - production time required to fulfill order.



\*\*Metal Bracing Rack - Code # BRRACK

## NUDURA Tall Wall Adapter Kit

Includes	20 Scaffold to Turnbuckle Adapters 20 Channel to Scaffold Adapters 20 Scaffold to Scaffold Adapters
----------	---

Code #	TW-KIT*
--------	---------

## Tall Wall Nut & Cross Tie Kit

Includes	50 Cross Ties 100 Nuts
----------	---------------------------

Code #	NUT-CR
--------	--------

## Tall Wall Connector Wires - 14" (356mm)

Includes	100 Connector Wires
----------	---------------------

Code #	TWCW14
--------	--------

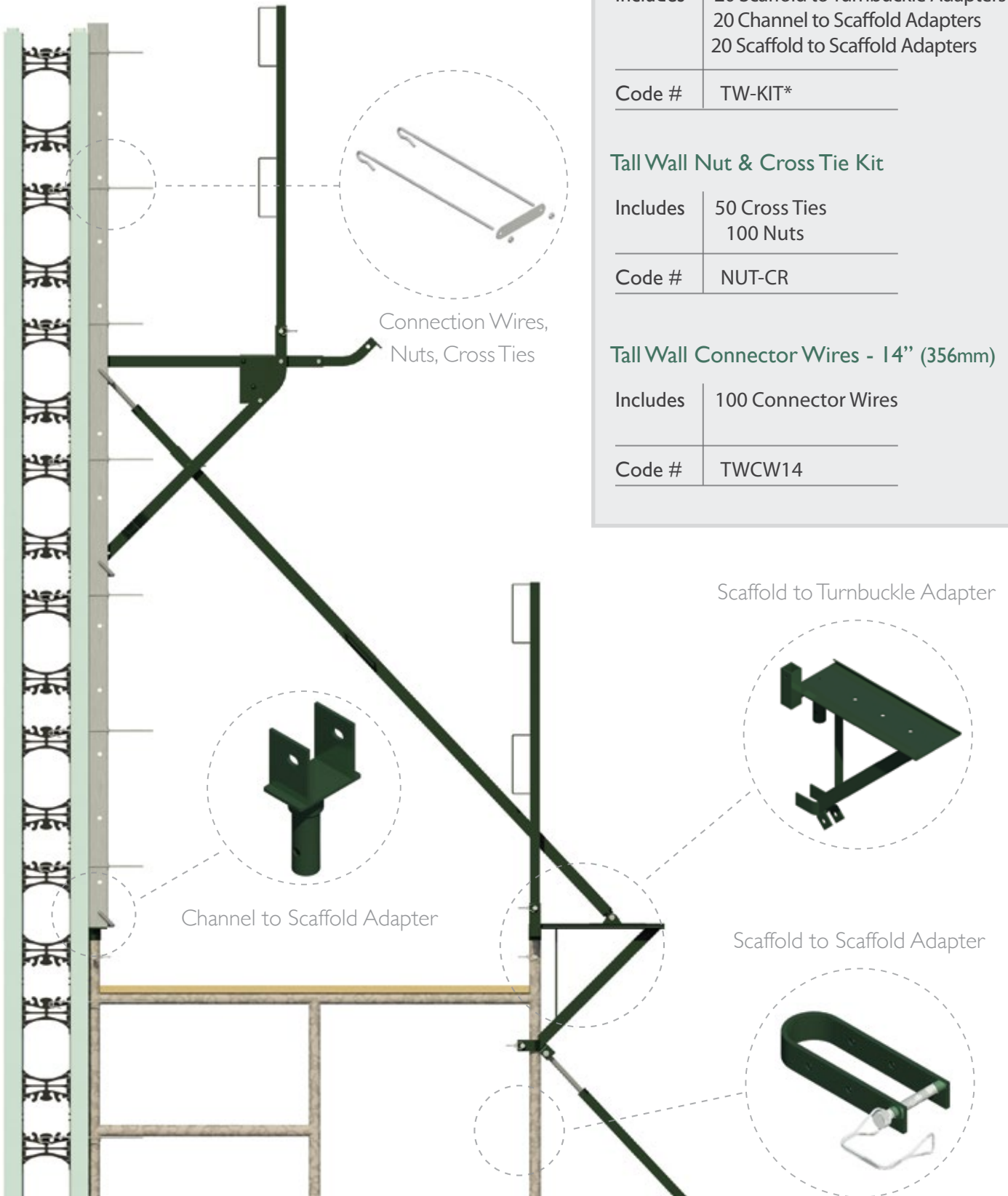

Diagram above illustrates Tall Wall Adapter Kit on Bracing. For reference only.

\*Special Order - production time required to fulfill order.  
**NOTE:** Tall Wall only compatible with square tube bracing.

## Technical support & customer service.

A NUDURA Authorized Distributor can provide you with extensive technical support and service such as: installation recommendations, up-to-date code compliance advice, product information and installation applications. A local distributor can also supply stock for smaller jobs. **Contact your local distributor for details or call 866-468-6299.**

## Professional online tools & resources.

The NUDURA website provides contractors, architects and design professionals with a full design details library, installation manual, how-to videos, a vast project photo gallery and much more. To access our online tools & resources **go to [nudura.com/resource-center](http://nudura.com/resource-center).**



## Basic installation training & AIA courses.

NUDURA offers a one-day training seminar to provide builders & installers with basic NUDURA Insulated Concrete Form installation skills to ensure that you get the knowledge you need to get the job done with efficiency and confidence. **To locate a training course held in your area visit [nudura.com/training](http://nudura.com/training).**

To provide you with current industry standards, NUDURA is also a registered provider with the AIA Continuing Education System. **For more program information visit [nudura.com/aia](http://nudura.com/aia).**





Over 50 years of building experience.

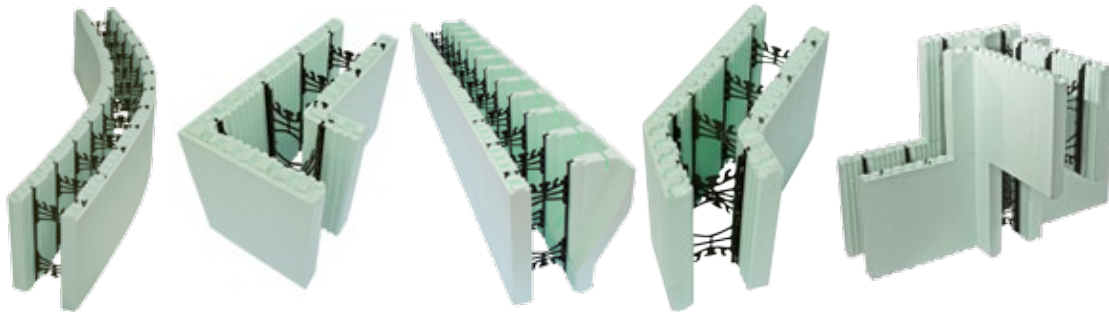

*By using NUDURA Insulated Concrete Forms to build your next structure you can ensure you are choosing the best building solution available today.*

Scan to learn more about the innovation behind NUDURA ICFs



The information contained in this NUDURA® Product Guide is presented only for the purpose of providing information on the various products forming part of the NUDURA Insulated Concrete Wall Forming System. This NUDURA Product Guide SHALL NOT be used as a substitute for professional engineering consultation. NUDURA makes no general warranties to the specific applicability of any of the products to any or all situations for which a designer may elect their specific use. Final amendment or modification to suit the exact circumstance of employment of any such products is the responsibility of the project designer. NUDURA has no control over the installation or workmanship used in the assembly or installation of the NUDURA products. Therefore, NUDURA cannot be held liable for any general, special, direct, indirect or consequential damages, including bodily harm, that may be suffered by any person including, without limitation, the installer, contractor, architect, engineer, homeowner or building owner due to the use, assembly or installation of the NUDURA products. The NUDURA products described herein are sold subject to the NUDURA Limited Warranty. NUDURA®, N Design®, Integrated Building Technology®, Building Has Evolved®, DURALOK Technology®, DURAFOLD Technology®, DURAMAX Technology® and DURA MULTI-LINK® are registered trademarks of NUDURA Inc. in Canada, the United States and other countries.

All other trademarks cited herein are the property of their respective owners.

PROD-C • ND1801E

Follow us on:

