

TECHO — BLOC

**TECHOSPEC**  
HARDSCAPER'S HANDBOOK

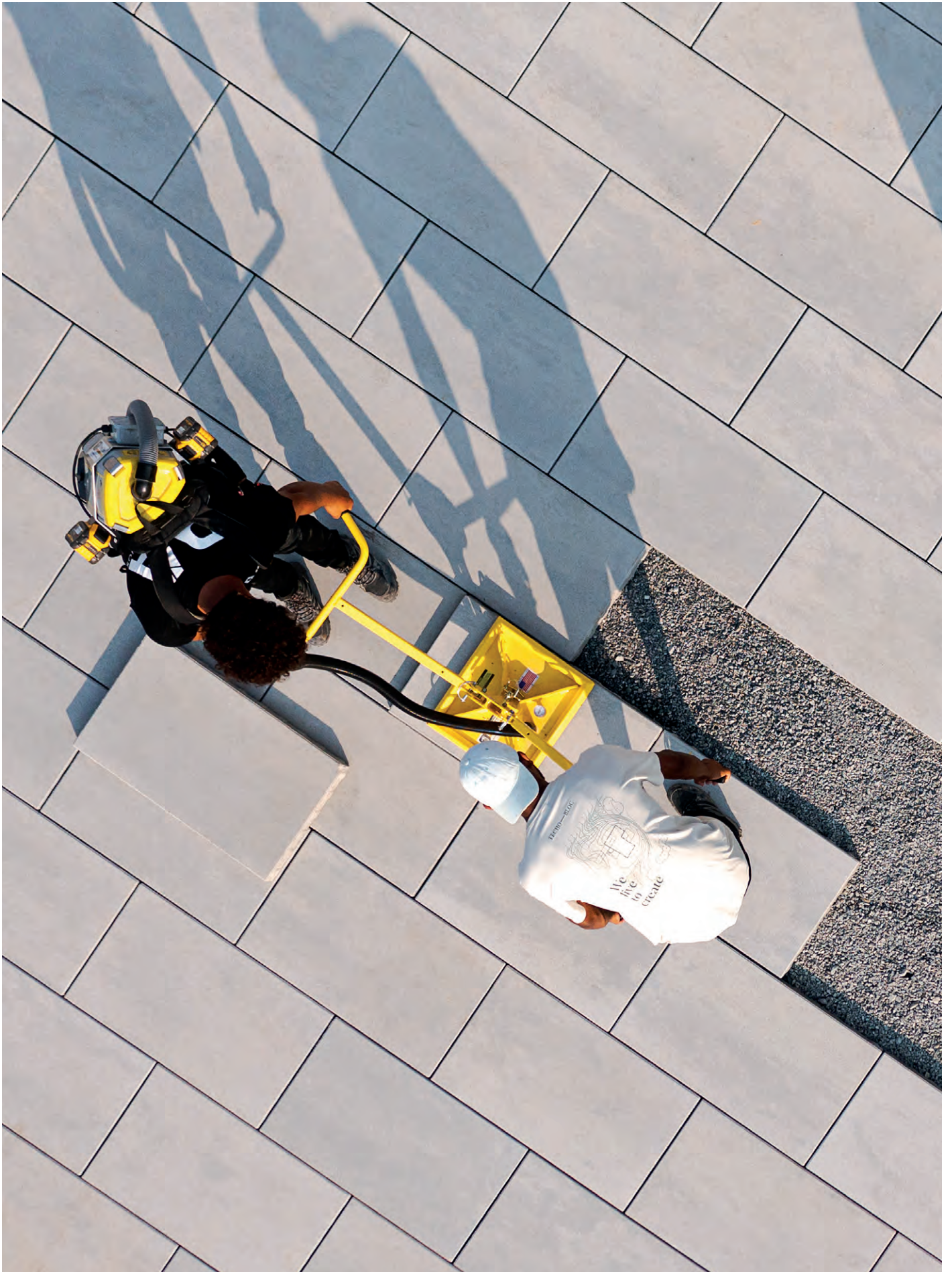



**We  
live  
to  
create**

**— TECHO — BLOC**

# IMPORTANT INFORMATION

## A STANDARD OF CARE

The care of high quality concrete products is similar to the care of any product left in the environment 365 days and nights per year. Very mild cleaning using detergents, water and product specific chemicals is necessary and similar to cleaning patio furniture, a vehicle's chrome, plastic, or paint, etc. in order to enhance their presence and charm. Protectants of all types (high, middle, and low sheen, pigmented/tinted, penetrating or film-forming) are available for additional protection from acid rain, stains and nature's worst. To get the most from your investments take care of them and they'll take care of you.

For any questions on industry-specific cleaners and protectants, see your local hardscape dealer, contact your contractor, contact us or search online.

It is contrary to Techo-Bloc's Standard Operating Procedures (SOP) to be involved in the care of a mature pavement or retaining structure. Care, as mentioned above, is the responsibility of the owner for any and all outdoor products.

CMHA disclaimer: "In areas where segmental retaining walls will be repeatedly exposed to snow (such as from plowing operations) consider periodically applying sealants or water repelling chemicals (silane or siloxane compounds) to the wall surface."

## COLOR

Due to the inherent nature of printed literature and current digital media, Techo-Bloc cannot guarantee specific color matching to printed representations of its color swatches.

Each color option is composed of a variety of darker & lighter tones. Natural ingredients such as granite are present within the recipe to allow for a range in tones, veining and textures from one stone to another. Therefore, colors samples shown are approximate representations of our standard colors and actual product colors may vary.

Final color selection should be made at your local dealer from stocked product. Techo-Bloc always recommends immediately verifying the product and colour upon reception. If there are any discrepancies, contact your local dealer before continuing your project. Installation of the product constitutes your acceptance of the product as is.

## EFFLORESCENCE

This warranty does not apply to efflorescence. Efflorescence is a naturally-occurring process in all concrete products which sometimes appears in the form of a white powdery film on the pavement surface. Efflorescence is more perceivable in darker colors such as Onyx Black and Chocolate Brown as there is a higher level of contrast than with other blended colours. It does not, in any way, compromise the functionality or the structural integrity of the product. Although efflorescence cannot be prevented, it will wash off over time or can be cleaned with efflorescence cleaner. Techo-Bloc accepts no responsibility or liability for this condition.

## POLYMERIC HAZE

Polymeric haze from the use of polymeric joint sand may appear on your concrete products if the sand was not removed from the surface of the paver properly. This does not, in any way, affect the integrity of the product or your installation. The hazing will weather away naturally with time and rain. It can be removed with a specialized cleaner; you are advised to contact your contractor or the polymeric sand company used for instructions & recommendations. Techo-Bloc accepts no responsibility or liability for this occurrence.

## CONSTRUCTION RESIDUE

A by-product of cutting with a saw is residue-filled water or concrete dust. Residue filled water or re-hydrated dust can cling to the surface and leave a concrete stain. It is recommended to wash and remove the water or concrete dust from the surface of the pavers before it dries. Construction residue can also happen through soil disturbance or environmental elements. These contaminants should be removed immediately but do not affect the integrity of the product or your installation. Techo-Bloc accepts no responsibility or liability for these occurrences.

## PROPER COLOR DISTRIBUTION AND LAYING TECHNIQUES

Proper installation enhances the overall color of pavement. Units should be randomly picked from at least two pallets when installing. This creates an attractive and subtle blending of color.

## COMPACTOR AND SNOW REMOVAL EQUIPMENT

Pavers with an embossed surface (high and low points) are more susceptible to scuff marks from vibratory plate compactors used in most concrete paver installations. Techo-Bloc recommends the use of a urethane mat between the plate and the paver surface during compacting. Contact your equipment supplier for more information about accessories for this purpose. Also, snow removal equipment should have the proper spacing, bumpers, and rubber blade guards to protect the surface of the pavers. Techo-Bloc is not responsible for damage caused by the misuse of compaction or snow removal equipment, which may leave scuff marks, or burns on pavers.

### NOTE:

For industry information about efflorescence, polymeric haze or information pertaining to installation specifications, please visit [www.icpi.org](http://www.icpi.org) or [www.ncma.org](http://www.ncma.org).

### INSTALLATION GUIDES:

The installation diagrams are only a guide or a reference and cannot cover all possible situations. Therefore, Techo-Bloc declines all responsibility regarding the applicability of the installation diagrams with regards to any specific site. The customer is fully responsible for product installation and Techo-Bloc recommends the use of qualified professionals, such as an architect, a master contractor or an engineer who will be able to customize the installation diagram to the specific site conditions.

## LIMITED WARRANTY

The warranty applies to drycast concrete landscaping and masonry products (“products”) manufactured by Techo-Bloc and intended for institutional, commercial or industrial use. Does not apply to Wet Cast collection products. All Techo-Bloc products comply with and surpass current applicable standards established by the American Society for Testing and Materials (ASTM) and the Canadian Standards Association (CSA).

Techo-Bloc warrants its products against these standards for a period of five (5) years commencing on the date the products are delivered to the job site. The warranty covers the structural integrity of the products and any abnormal deterioration of its surfaces that may be caused by the use of rock salt (sodium chloride [NaCl]) for de-icing pavers, slabs or steps.

The warranty applies on the condition that the plans and specifications of the project have been prepared by a qualified professional.

Techo-Bloc’s warranty excludes any third party products.

The following conditions or events are not covered by the warranty:

1. Claims regarding the color, size, or texture of a product already installed. An installed product confirms the acceptance of the product received.
3. Splitting, chipping or other breakage that could be caused by impact, abrasion or overloading.
3. Damage or loss caused by settling or other movements or failure of the structure or other components to which the products are set upon.
4. Damage or loss caused by design or installation not in compliance with local codes, industry standards or the guidelines provided by the Concrete Masonry and Hardscape Association (CMHA) or Techo-Bloc.
5. Natural disaster, including but not limited to, earthquakes, floods or other similar natural disasters.
6. Acts of negligence or misuse by the owner, installer or any third party.
7. Color matching to printed representations.
8. Efflorescence, polymeric haze or construction-born residue.
9. Damage or loss caused by impacts by compaction or snow removal equipment.
10. Installation of Wet Cast collection products in a commercial, industrial or institutional setting destined for public use.

In the event of product failure within the scope of this warranty, Techo-Bloc will replace the affected units only, following a site inspection and assessment of the products by Techo-Bloc or its representatives. Techo-Bloc’s responsibility is limited to the cost of the product only and not to the costs related to the installation or replacement of said products.

**Note that replacement pieces may show noticeable differences in color, texture, or finish. These variations are a natural result of using materials from different manufacturing batches and are not considered defects and therefore are not covered under the Techo-Bloc warranty.**

Techo-Bloc will honor this warranty only with a proof of purchase, such as an invoice or delivery slip.

# TABLE OF CONTENTS

Important Information	4
Warranties	5

<b>THE DESIGN PLAYGROUND</b>	<b>8</b>
Textures	8
Colors	10
Technologies	14
Mosaics and Augmented Reality	16
Solar Reflectance Index	18
Color Coordinate	19
Industria Colors and Product Availability	22
Typical Application Usage	26
Installation Guides	28
Nominal Dimensions	33
Joint Width	33

<b>SLABS</b>	<b>34</b>
<i>General Technical information</i>	34
<i>Installation guides</i>	35
Aberdeen Klean-Bloc	37
Blu 60 mm Slate, HD <sup>2</sup> Slate	39
Blu 60 mm Smooth, HD <sup>2</sup> Smooth	40
Blu 60 mm Polished	41
Blu 60 mm 6"x13" Slate, HD <sup>2</sup> Slate	42
Blu 60 mm 6"x13" Smooth, HD <sup>2</sup> Smooth	43
Blu Grande Slate, HD <sup>2</sup> Slate	44
Blu Grande Smooth, HD <sup>2</sup> Smooth	45
Blu Grande Polished	46
Borealis Klean-Bloc	47
Borealis Stepping Stone	48
Everest Square	49
Everest Rectangle	50
Hexa 60 mm	51
Industria HD <sup>2</sup>	52
Industria Flora	53
Maya	54
Para HD <sup>2</sup>	55
Sandstone	57
Terrazzo	58
Travertina Raw Klean-Bloc	60

<b>PAVERS</b>	<b>62</b>
<i>General technical information</i>	62
<i>Installation guides</i>	63
Antika Smooth	64
Blu 80 mm Slate, HD <sup>2</sup> Slate	66
Blu 80 mm Smooth, HD <sup>2</sup> Smooth	67
Blu 80 mm Polished	68
Blu 80 mm 6"x13" Slate, HD <sup>2</sup> Slate	69
Blu 80 mm 6"x13" Smooth, HD <sup>2</sup> Smooth	70
Diamond HD <sup>2</sup>	71
Eva	72
Hexa 100 mm	73
Industria 150 Series HD <sup>2</sup>	74
Industria 200 Series HD <sup>2</sup>	76
Industria 300 Series HD <sup>2</sup>	78
Industria 450 Series HD <sup>2</sup>	82
Industria 600 Series HD <sup>2</sup>	84
Industria 900 Series HD <sup>2</sup>	88
Linea Small Rectangles	90
Linea Large Rectangles	91
Mista Random	92
Sleek HD <sup>2</sup>	93
Squadra Slate	94
Terrazzo	95
Valet	96
Victorien 60 mm	97
Villagio	98
Westmount	99

## PERMEABLE PAVERS 100

<i>General technical information</i>	100
<i>Installation guides</i>	102
Aquastorm	106
Hydra	107
Mika Klean-Bloc	108
Pure	109
Saint-Oxford Klean-Bloc	110

## OUTDOOR FEATURES 111

Lumi Fire Bowl	112
Lumi Planter	113
Sculptura Collection - Square	114
Sculptura Collection - Rectangle	115
Sculptura Collection - Circle, Scalloped	116
Brandon Rectangular Fire pit	117
<i>Installation guides</i>	118
Brandon Square Fire pit	119
<i>Installation guides</i>	120
Prescott Fire Pit	121
<i>Installation guides</i>	122
Raffinato Fire Pit	123
<i>Installation guides</i>	124
Valencia Fire Pit	125
<i>Installation guides</i>	126
Burners and Accessories	127

## EDGES 129

<i>Installation guides</i>	130
Avignon	133
Borealis	134
Brandon	135
Pietra	136
Raffinato 90 mm Smooth & Polished	137
Raffinato 180 mm Smooth & Polished	138
Röcka	139

## WALLS 140

<i>Application Chart</i>	141
<i>Installation guides</i>	142
<i>Compatibility Chart</i>	145
<i>Installation Guide Retaining Wall</i>	146
Borealis	162
<i>Installation guides</i>	163
Brandon 90 mm	164
Brandon 180 mm	166
Brandon 90 & 180 mm	167
<i>Design Chart</i>	168
<i>Installation guides</i>	169
Fascia Wall Collection	176
Iconic Fascia Wall Collection Klean-Bloc	177
Rosemont Fascia Wall Collection Klean-Bloc	178
<i>Installation guides</i>	179
G-Force	183
G-Force Corner	184
<i>Design Chart</i>	185
<i>Installation guides</i>	186
Graphix	187
<i>Design Chart</i>	188
<i>Installation guides</i>	190
Mini-Creta 3" Architectural	192
Mini-Creta 6" Architectural	193
Pillar 24" Mini-Creta Architectural	194
<i>Design Chart</i>	195
<i>Installation guides</i>	196
Prescott 2.25"	203
Prescott 4.5"	204

Prescott Corner & Pillar	205
<i>Installation guides</i>	206
Raffinato 90 & 180 mm Polished	211
Raffinato 90 & 180 mm Smooth	212
Pillars, corners and edge Polished	213
Pillars, corners and edge Smooth	214
<i>Design Chart</i>	215
<i>Installation guides</i>	216
Röcka	222
<i>Installation guides</i>	223
Sandstone	225
<i>Installation guides</i>	226
Semma	227
Semma Corner or Pillar	228
<i>Design Chart</i>	229
<i>Installation guides</i>	230
Skyscraper	233
<i>Design Chart</i>	235
<i>Installation guides</i>	236
Systema	239
<i>Installation guides</i>	240
Travertina Raw	241
Travertina Raw Corner & Pillar	242
<i>Installation guides</i>	243

## STEPS & CAPS 245

<i>Compatibility Chart</i>	246
<i>Installation guides</i>	247
Borealis	251
Maya	252
Raffinato	253
Röcka	254
<i>Installation guides</i>	255
Sandstone (Step)	256
Terrazzo (Step)	257
York	258
Blu 45 mm Slate	259
Blu 45 mm Smooth	260
Sandstone (Overlay System)	261
Venetian Slate	262
Venetian Smooth	263
Architectural	264
<i>Installation guides</i>	265
Bali Travertina Raw Klean-Bloc	266
Brandon	267
Limestone	268
Sandstone & Sandstone Bullnose	269
Bullnose	270
Bullnose Grande	271
Graphix	272
Piedimonte Klean-Bloc	273
Portofino	274
<i>Installation guides</i>	275
Raffinato 14"x28"	276
Raffinato 14"x32"	277
Terrazzo & Terrazzo Bullnose (Caps)	278
Travertina Raw Klean-Bloc	279
York Pillar Cap Klean-Bloc	280
York Wall Cap Klean-Bloc	281
York Counter Top Klean-Bloc	282

## ACCESSORIES 283

### LEGEND

<b>D</b> DRY CAST COLLECTION	PERMEABLE PAVERS	RESIDENTIAL - PEDESTRIAN	COMMERCIAL - LIGHT
<b>W</b> WET CAST COLLECTION	DE-ICING SALT RESISTANT	RESIDENTIAL - VEHICULAR	COMMERCIAL - INTERMEDIATE
<b>HD<sup>2</sup></b> HIGH DEFINITION & DENSITY	<b>DO NOT USE</b> DE-ICING SALT	ADA	COMMERCIAL - OCCASIONAL HEAVY
<b>KB</b> KLEAN-BLOC	USE VIBRATING PLATE	MECHANICAL INSTALLATION	COMMERCIAL - HEAVY
NATURAL STONE	<b>DO NOT USE</b> VIBRATING PLATE		



# Contractor Support Manual

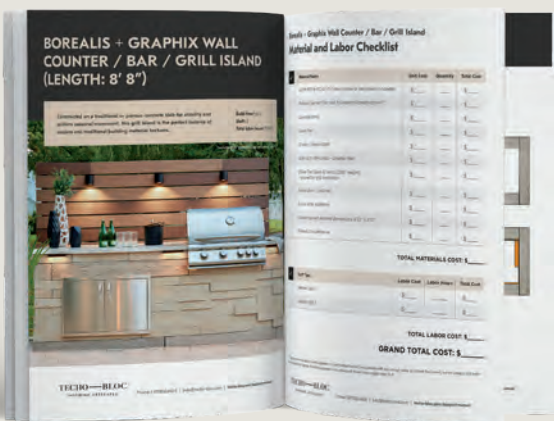

## Download over 25 construction guides

Build outdoor features quickly and easily. Each feature is complete with material lists, step-by-step instructions and detailed drawings.

### Includes:

- Firepits
- Cooking Solutions
- Water Features
- Seating



Download free guides

# TEXTURES



## HD² SMOOTH

Blu (p. 40, 43, 45, 67, 70) Para (p. 55, 56)  
Diamond (p. 71) Sleek (p. 93)  
Flora (p. 46) Westmount (p. 99)  
Hexa (p. 51, 73)  
Industria (p. 52, 74, 76,  
78, 79, 82, 84, 86, 88)

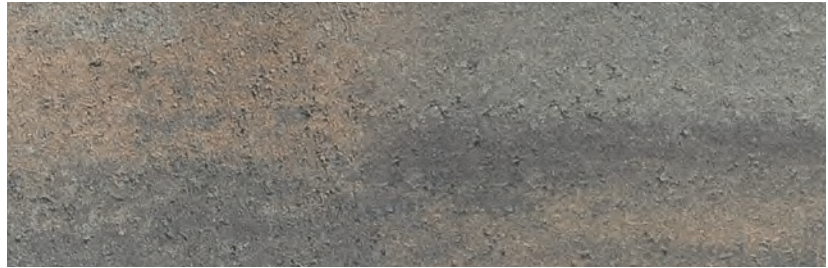

## SMOOTH

Antika (p. 65) G-Force (p. 183, 184) Venetian Overlay System (p. 263)  
Aquastorm (p. 106) Graphix (p. 188, 272) Victorien (p. 97)  
Blu (p. 40, 43, 45, 67, 70) Hydra (p. 107)  
Blu Overlay System (p. 260) Linea (p. 90, 91)  
Bullnose (p. 261) Raffinato (p. 123, 137, 138, 212,  
214, 253, 276)  
Eva (p. 72) Skyscraper (p. 233, 234)



## HD² SLATE

Blu (p. 31, 34, 36, 66, 69)  
Everest (p. 49, 50)



## SLATE

Avignon (p. 133) Prescott (p. 121, 203, 204, 205)  
Blu (p. 39, 42, 44, 66, 69) Portofino Cap (p. 274)  
Blu Overlay System (p. 259) Pure (p. 108)  
Brandon (p. 117, 119, 135, 165,  
166, 167, 267) Röcka (p. 222, 254)  
Eva (p. 72) Squadra (p. 96)  
Maya (p. 54, 252) Venetian Overlay System (p. 262)  
Mista (p. 65) Villagio (p. 99)

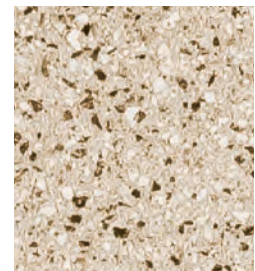

## POLISHED

Blu (p. 41, 46, 68)  
Bullnose Grande (p. 271)  
Raffinato (p. 137, 138, 211, 213)



## HD² POLISHED

Industria (p. 52, 75, 77, 80, 81, 83, 85, 87, 89)



## HD² GRANITEX

Diamond (p. 71)  
Industria (p. 52, 74, 76, 78, 79, 82, 84, 86, 88)



## POLISHED (TERRAZZO)

Terrazzo (p. 58, 59, 95, 257, 278)



## NATURAL STONE

Limestone (p. 268)  
Sandstone (p. 57, 225, 255, 266, 269)

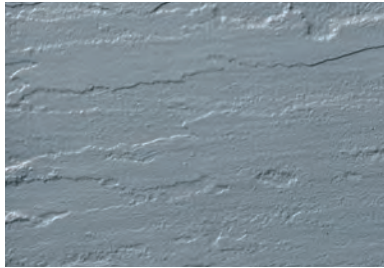

## KLEAN-BLOC SLATE

Aberdeen (p. 37, 38)      Fascia Rosemont (p. 178)  
Mika (p. 108)  
Saint-Oxford (p. 110)      Piedimonte (p. 273)  
Fascia Iconic (p. 177)      York (p. 280, 281, 282 )



## SPLIT FACE

Architectural (p. 264)      Semma (p. 227, 228)  
Graphix (p. 188, 272)      Valencia (p. 125)  
Pietra (p. 136)



## KLEAN-BLOC BRUSHED TRAVERTINE

Travertina Raw (p. 60, 36, 279)

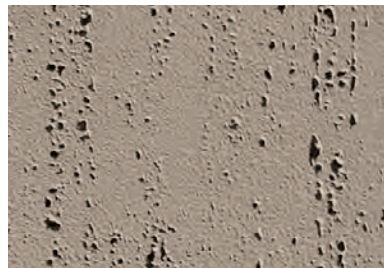

## BRUSHED TRAVERTINE

Travertina Raw (p. 241, 242)



## BASALT

Valet (p. 96)



## KLEAN-BLOC WOOD

Borealis (p. 47)

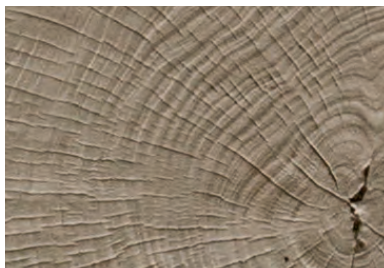

## WOOD

Borealis (p. 48, 134, 162, 251)

# WARM SHADES

EARTHY, ON-TREND HUES THAT RADIATE  
WARMTH AND TIMELESS CHARACTER.

## BEIGE

## BROWN

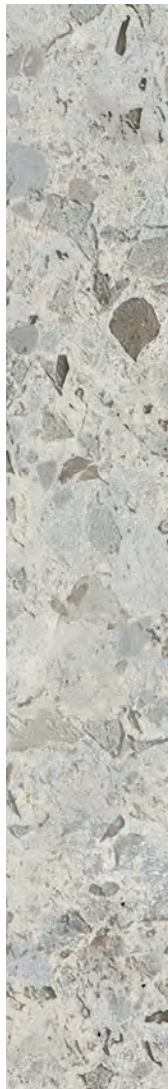

STARDUST BEIGE  
POLISHED



IVORY  
BRUSHED TRAVERTINE

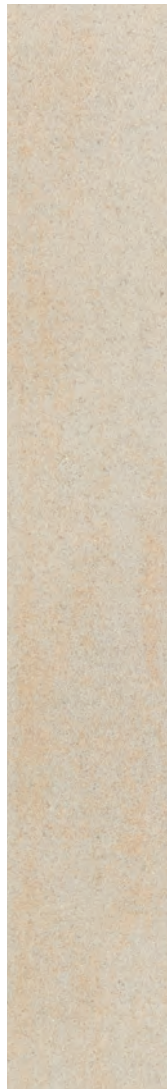

BEIGE CREAM  
SMOOTH

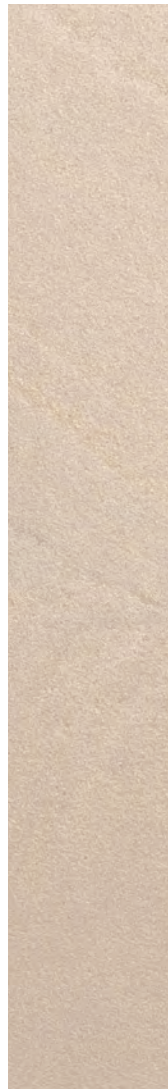

BEIGE  
NATURAL STONE



CAFFÈ CREMA  
SMOOTH



ROCK GARDEN BROWN  
SLATE

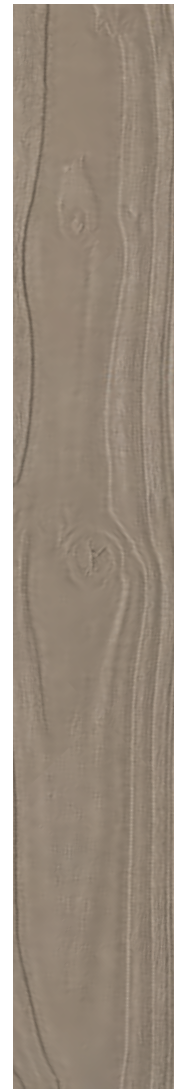

HAZELNUT BRANDY  
WOOD

DISCOVER  
ALL DESIGN  
POSSIBILITIES



RED



SANDLEWOOD  
BEVELED



CHESTNUT BROWN  
BASALT



SMOKED PINE  
**K** WOOD

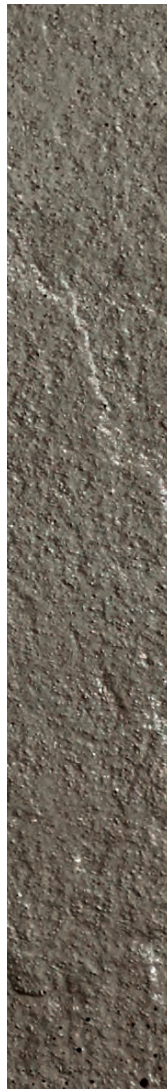

SEPIA BROWN  
**K** SLATE



CHOCOLATE BROWN  
SLATE

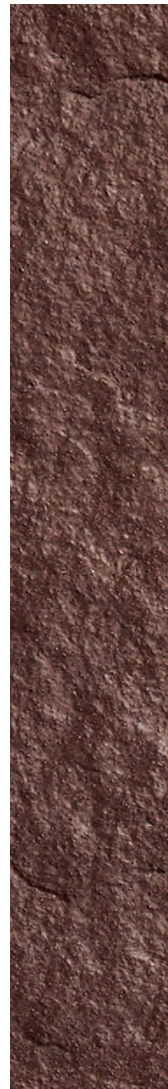

BORDEAUX RED  
**K** SLATE



MERLOT  
**FD** SMOOTH

# COOL TONES

REFINED GREYS THAT SHAPE CALM,  
MODERN, AND ARCHITECTURAL SPACES.

WHITE

GREY

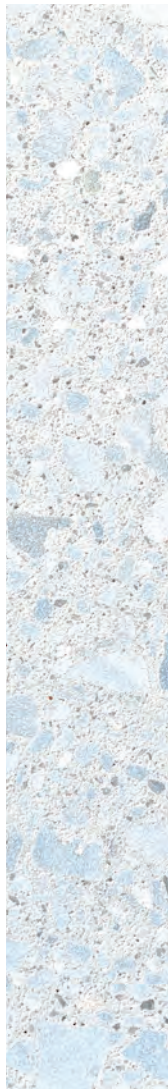

MINERAL WHITE  
POLISHED

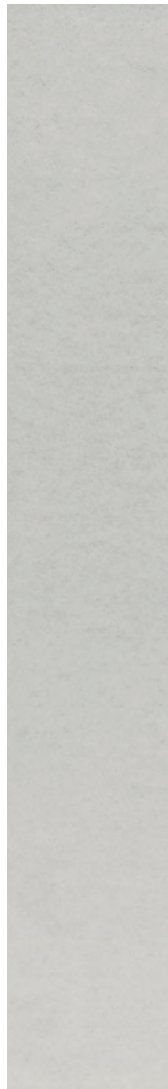

COOL GREY  
SMOOTH



GREYED NICKEL  
P32 SMOOTH

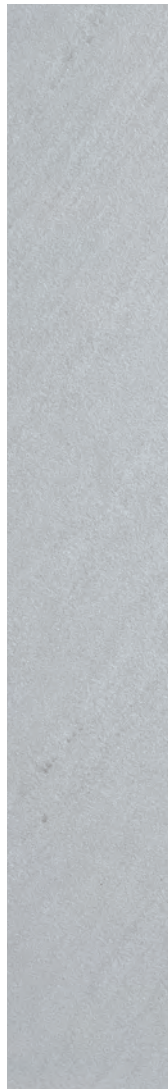

GREY  
NATURAL STONE



SILVER GRANITE  
P32 SMOOTH



VICTORIA  
P32 SLATE

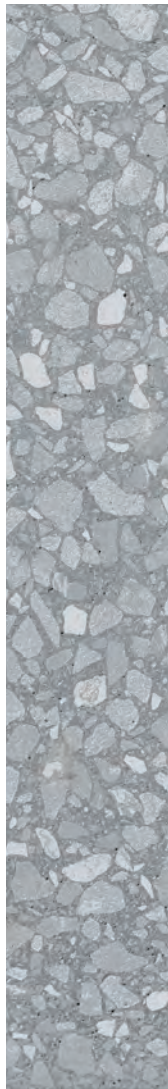

MOONROCK GREY  
POLISHED

DISCOVER  
ALL DESIGN  
POSSIBILITIES



BLACK



RIVIERA  
WOOD



AZZURRO  
SLATE



SHALE GREY  
SMOOTH



CHAMPLAIN GREY  
SMOOTH



MIDNIGHT GREY  
SLATE

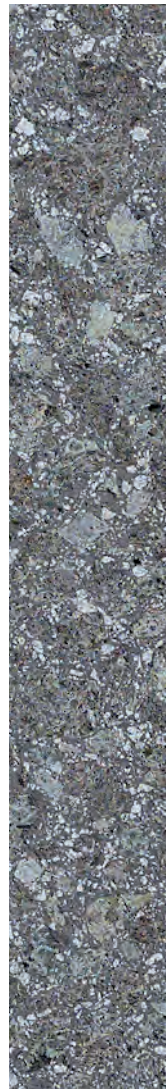

METEOR BLACK  
POLISHED



ONYX BLACK  
SMOOTH

# FINISHES THAT FIT YOUR LIFESTYLE

## THREE WAYS TO ELEVATE YOUR OUTDOOR SPACE.

Each surface offers a different experience. Whichever you choose, you're investing in beauty, design, and long-lasting performance.



### ULTIMATE STAIN RESISTANCE

Developed to seal in the beauty of wet cast products, Klean-Bloc technology provides an advanced protective barrier against everyday spills. Enjoy the beauty and character of natural materials like travertine and wood grain, without the worry of maintenance.

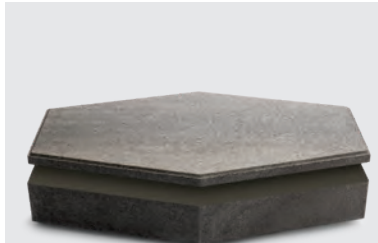

### VIBRANT COLOR & LESS PORES

Boasting higher particles per square inch, this dry cast technology leads to a tighter surface with less pores for the most flawless of finishes. From the smoothest smooth to the most intricate textures, HD² products are always ready for a close-up.



### QUALITY AND DURABILITY YOU CAN TRUST

With 35+ international patents, we aim to strike the perfect balance between beauty and durability. All Techo-Bloc stones are engineered to handle freeze-thaw climates, and are the ideal building blocks for any style of landscape design.

	<b>W</b> WET CAST	<b>D</b> DRY CAST	DURABILITY	ULTRA-DETAILED TEXTURE	VIBRANT COLOR	STAIN RESISTANCE	REDUCED ABSORPTION RATE	SUPERIOR STRENGTH	DE-ICING SALT RESISTANT
	✓		✓	✓	✓	✓	✓		✓
		✓	✓	✓	✓			✓	✓
ESSENTIAL COLLECTION	✓	✓	✓						✓



**KLEAN  
-BLOC**



**HD2**

**ESSENTIAL  
COLLECTION**

EXPLORE  
OUR EXCLUSIVE  
TECHNOLOGIES



# BRING CREATIVE PATTERNS TO LIFE

VIEW IN YOUR SPACE WITH  
AUGMENTED REALITY. SPOT OUR  
QR CODES THROUGHOUT THIS  
SECTION TO TRY OUR MOSAICS IN  
AUGMENTED REALITY.

Envision the luxury of seeing beauty settle into your space before a single choice is made. With our augmented reality experience, mosaics transcend the page and reveal themselves as though they were always meant to be part of your world. Through the lens of your phone, patterns appear at their true scale, alive with detail, responding to light, shadow, and the textures of your surroundings.



SCAN THIS QR CODE  
TO VISUALIZE  
OUR MOSAICS





### HOW TO VISUALIZE YOUR SPACE

1. Scan the QR code next to the product.
2. Point your phone at your yard or outdoor area.
3. Watch the product appear in real size.
4. Snap a photo to save or share!

# SOLAR REFLECTANCE & LEED CREDITS

## TECHO-BLOC TEXTURES AND COLORS SOLAR REFLECTANCE (SR) AND SOLAR REFLECTANCE INDEX (SRI)

FINISH	SOLAR REFLECTANCE <sup>1</sup>	SOLAR REFLECTANCE INDEX <sup>2</sup>
Pure White		
HD <sup>2</sup> Smooth	0.57	67
HD <sup>2</sup> Polished	0.50	58
HD <sup>2</sup> Granitex	0.55	60
Mineral White		
Polished (Terrazzo)	0.58	70
Salt & Pepper		
HD <sup>2</sup> Smooth	0.53	62
HD <sup>2</sup> Granitex	0.51	60
Moonrock Grey		
Polished (Terrazzo)	0.36	40
Natural Stone Grey		
Sandstone	0.39	43
Silver Granite		
HD <sup>2</sup> Smooth	0.40	45
Greyed Nickel		
HD <sup>2</sup> Smooth	0.37	41
Smooth	0.34	37
HD <sup>2</sup> Polished	0.37	41
HD <sup>2</sup> Granitex	0.39	43
HD <sup>2</sup> Slate (drycast)	0.34	38
Victoria		
HD <sup>2</sup> Slate (wetcast)	0.31	33
Ivory		
Klean-Bloc Brushed Travertine (wetcast)	0.40	45
Klean-Bloc Slate (wetcast)	0.42	48
Beige Cream		
HD <sup>2</sup> Smooth	0.38	42
Smooth	0.33	36
HD <sup>2</sup> Polished	0.38	42
HD <sup>2</sup> Granitex	0.33	36

FINISH	SOLAR REFLECTANCE <sup>1</sup>	SOLAR REFLECTANCE INDEX <sup>2</sup>
Caffè Crema		
HD <sup>2</sup> Smooth	0.36	38
Natural Stone Beige		
Sandstone	0.47	54
Hazelnut Brandy		
Klean-Bloc Slate (wetcast)	0.37	41
Rock Garden Brown		
Klean-Bloc Slate (wetcast)	0.21	20
Chestnut Brown		
HD <sup>2</sup> Smooth	0.21	20
Smooth	0.26	27
HD <sup>2</sup> Polished	0.22	22
HD <sup>2</sup> Granitex	0.28	29
HD <sup>2</sup> Slate (drycast)	0.19	18
Slate	0.23	25
Sandlewood		
Slate	0.21	23
Smoked Pine		
Klean-Bloc Wood (wetcast)	0.22	22
Sepia Brown		
Klean-Bloc Slate (wetcast)	0.14	11
Chocolate Brown		
Smooth	0.10	6
Merlot		
HD <sup>2</sup> Smooth	0.15	13
Beveled	0.14	11
Slate	0.09	5
Bordeaux Red		
Klean-Bloc Slate (wetcast)	0.09	5

FINISH	SOLAR REFLECTANCE <sup>1</sup>	SOLAR REFLECTANCE INDEX <sup>2</sup>
Champlain Grey		
HD <sup>2</sup> Smooth	0.25	25
Smooth	0.25	25
HD <sup>2</sup> Slate (drycast)	0.23	23
Slate	0.23	24
Shale Grey		
HD <sup>2</sup> Smooth	0.21	19
Smooth	0.25	26
HD <sup>2</sup> Polished	0.17	15
HD <sup>2</sup> Granitex	0.29	31
HD <sup>2</sup> Slate (drycast)	0.14	11
Slate	0.24	26
Grey		
HD <sup>2</sup> Smooth	0.30	31
Smooth	0.25	25
HD <sup>2</sup> Polished	0.35	39
HD <sup>2</sup> Granitex	0.37	42
Riviera		
HD <sup>2</sup> Slate (wetcast)	0.18	16
Klean Bloc Brushed Travertine (wetcast)	0.16	14
Azzuro		
Klean-Bloc Slate (wetcast)	0.15	12
Meteor Black		
Polished (Terrazzo)	0.16	13
Charcoal		
HD <sup>2</sup> Smooth	0.14	11
HD <sup>2</sup> Polished	0.21	20
HD <sup>2</sup> Granitex	0.20	19
Midnight Grey		
Klean-Bloc Slate (wetcast)	0.09	5
Onyx Black		
HD <sup>2</sup> Smooth	0.09	6
Smooth	0.09	6
HD <sup>2</sup> Polished	0.13	10
HD <sup>2</sup> Granitex	0.16	14
Klean-Bloc Slate (wetcast)	0.06	1

NOTES  
 1. Solar Reflectance measurements in accordance with ASTM C1549 "Standard Test Method for Determination of Solar Reflectance Near Ambient Temperature Using a Portable Solar Reflectometer".  
 2. Solar Reflectance Index (SRI) calculated in accordance with ASTM E1980 "Standard Practice for Calculating Solar Reflectance Index of Horizontal and Low-Sloped Opaque Surfaces".  
 3. Solar Reflectance and Solar reflectance index (SRI) are obtained from average testing values of an independent laboratory.  
 4. Values may change slightly for the same color and texture due to variations in local aggregates.  
 5. Contact your Techo-Bloc Representative for current SR and SRI values

# COLOR COORDINATE

For an authentic look, each color option is composed of a variety of darker & lighter tones. Natural ingredients such as granite are present within the recipe to allow for a range in tones, veining and textures from one stone to another. Final color selection should be made with your contractor from product samples or at your local dealer from stocked product. This color chart serves as a guide for color selection across product lines.

x Available

Ⓢ Permeable

Slabs	Merlot	Bordeaux Red	Chocolate Brown	Sepia Brown	Chestnut Brown	Sandlewood	Smoked Pine	Rock Garden Brown	Hazelnut Brandy	Champaign Grey	Caffè Crema	Beige Cream	Beige	Ivory	Stardust/Beige	Pure White	Mineral White	Salt & Pepper	Cool Grey	Victoria	Greyed Nickel	Silver Granite	Moonrock Grey	Midnight Grey	Grey	Warm Grey	Shale Grey	Riviera	Azzurro	Meteor Black	Onyx Black	Limestone Black		
Aberdeen Klean-Bloc								x																								x		
Blu 45 mm Overlay System - Slate					x				x																		x							
Blu 45 mm Overlay System - Smooth					x				x		x										x						x						x	
Blu 60 mm - Slate Ⓢ					x				x																		x							
Blu 60 mm - HD <sup>2</sup> Slate Ⓢ					•				•																		•							
Blu Grande - Slate					x				x																		x							
Blu Grande - HD <sup>2</sup> Slate					•				•																		•							
Blu 60 mm (6 x 13) - Slate Ⓢ			x		x				x																		x						x	
Blu 60 mm (6 x 13) - HD <sup>2</sup> Slate Ⓢ					•				•																		•							
Blu 60 mm Smooth Ⓢ					x				x		x										x						x							x
Blu 60 mm HD <sup>2</sup> Smooth Ⓢ					x				x	x	x										x						x							x
Blu 60 mm (6 x 13) - Smooth Ⓢ			x		x				x		x										x						x							x
Blu 60 mm (6 x 13) - HD <sup>2</sup> Smooth Ⓢ					x				x	x	x										x						x							x
Blu Grande - Smooth					x				x		x										x						x							x
Blu Grande HD <sup>2</sup> Smooth					x				x	x	x										x						x							x
Blu 60 mm & Grande - Polished					x						x										x						x							x
Borealis Klean-Bloc							x		x																			x						
Borealis Stepping Stones								x																										
Everest					x					x											x						x							
Flora											x										x													
Hexa 60 mm					x				x	x											x						x							x
Industria HD <sup>2</sup> - 600 Series					x					x	x										x						x							x
Maya																					x							x						
Para										x	x											x												x
Sandstone													x													x								
Terrazzo															x																			
Travertina Raw Klean-Bloc								x						x																				

## NOTES

Please note that for barefoot walking areas (e.g. pool deck) dark-colored paving units could get very hot under the sun.



## Walls & Pillars

	Merlot	Bordeaux Red	Chocolate Brown	Sepia Brown	Chestnut Brown	Sandlewood	Smoked Pine	Rock Garden Brown	Hazelnut Brandy	Champlain Grey	Caffè Crema	Beige Cream	Beige	Ivory	Stardust Beige	Pure White	Mineral White	Salt & Pepper	Cool Grey	Victoria	Greyed Nickel	Silver Granite	Opal Grey	Midnight Grey	Grey	Warm Grey	Shale Grey	Riviera	Azzurro	Meteor Black	Onyx Black	Limestone Black	
Borealis							x		x																								
Brandon					x					x																		x					x
Fascia Wall Collection Klean-Bloc								x																					x	x			
G-Force					x					x																							
Graphix												x										x											x
Mini-Creta Architectural Wall					x	x				x	x											x						x					
Mini-Creta Architectural Pillars					x	x				x	x											x						x					
Prescott Collection								x													x								x				
Raffinato Collection											x	x										x						x					x
Röcka			x					x																					x				
Sandstone													x												x								
Semma					x	x				x																		x					
Skyscraper					x																							x					
Systema					x				x	x												x					x						x
Travertina Raw								x						x															x				

## Steps, caps and overlay system

Architectural Cap				x	x				x	x												x						x				x	
Bali Travertina Cap Klean-Bloc							x						x															x					
Brandon Cap				x						x																		x					x
Bullnose Cap			x	x						x																		x					x
Bullnose Grande Cap												x										x											
Graphix Cap												x										x											x
Limestone																																	x
Piedimonte Cap Klean-Bloc								x																					x				x
Portofino Cap								x																					x	x			x
Raffinato Cap Collection				x					x	x	x											x					x						x
Sandstone Cap													x												x								
Sandstone Bullnose													x												x								
Sandstone Bullnose 16 x 48													x												x								
Terrazzo Cap & Bullnose Cap															x		x							x							x		
Travertina Raw Cap Klean-Bloc								x						x														x					
York Collection Cap Klean-Bloc			x					x						x															x				x
Borealis Step							x		x																								
Maya Step								x																					x				
Raffinato Step											x	x										x						x					x
Sandstone Step																										x							
Systema Step					x							x	x									x					x						x
Terrazzo Step															x		x							x							x		
Röcka Step			x					x																					x				
York Step								x																					x				
Venetian Overlay System - Slate					x					x																		x					
Venetian Overlay System - Smooth					x					x																		x					



## INDUSTRIA COLORS

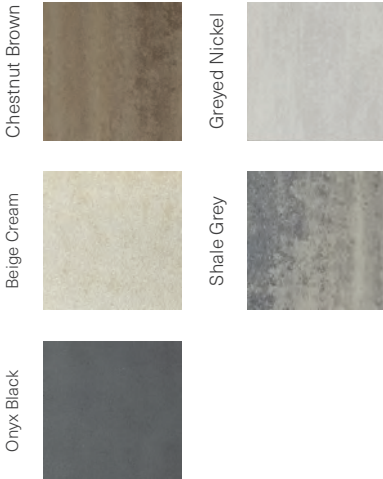

### IN STOCK

**HD<sup>2</sup>** SMOOTH

- 300 series**  
300 × 100 × 100  
300 × 150 × 100  
300 × 300 × 100  
Triangle
- 600 series**  
600 × 600 × 60  
600 × 600 × 100
- 900 series**  
900 × 300 × 100  
900 × 600 × 60  
900 × 600 × 100  
900 × 900 × 100

### ON ORDER ONLY\*

**HD<sup>2</sup>** GRANITEX —  
**HD<sup>2</sup>** POLISHED

- 300 series**  
300 × 100 × 100  
300 × 150 × 100  
300 × 300 × 100  
Triangle
- 600 series**  
600 × 600 × 60  
600 × 600 × 100
- 900 series**  
900 × 300 × 100  
900 × 600 × 60  
900 × 600 × 100  
900 × 900 × 100

**HD<sup>2</sup>** SMOOTH —  
**HD<sup>2</sup>** GRANITEX —  
**HD<sup>2</sup>** POLISHED

- 150 series**  
150 × 150 × 100
- 200 series**  
200 × 200 × 100  
200 × 400 × 100
- 450 series**  
450 × 100 × 100  
450 × 150 × 100  
450 × 300 × 100
- 600 series**  
600 × 100 × 100  
600 × 200 × 100  
600 × 300 × 100

\*Minimum order 2,000 SF. For orders under 2,000 SF, setup fees may apply. Please contact your local Commercial Sales Rep for project pricing and support.

\*Minimum order 500 SF. For orders under 500 SF, setup fees may apply. Please contact your local Commercial Sales Rep for project pricing and support.

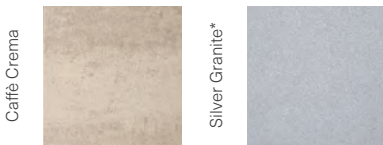

**HD<sup>2</sup>** SMOOTH

- 600 series**  
600 × 600 × 60  
600 × 600 × 100
- 900 series**  
900 × 300 × 100  
900 × 600 × 60  
900 × 600 × 100  
900 × 900 × 100

**HD<sup>2</sup>** SMOOTH —  
**HD<sup>2</sup>** GRANITEX —  
**HD<sup>2</sup>** POLISHED

- 150 series All sizes  
200 series All sizes  
300 series All sizes  
450 series All sizes

- 600 series**  
600 × 100 × 100  
600 × 200 × 100  
600 × 300 × 100

\*Silver Granite is only available in HD<sup>2</sup> Smooth.

\*Minimum order 2,000 SF. For orders under 2,000 SF, setup fees may apply. Please contact your local Commercial Sales Rep for project pricing and support.

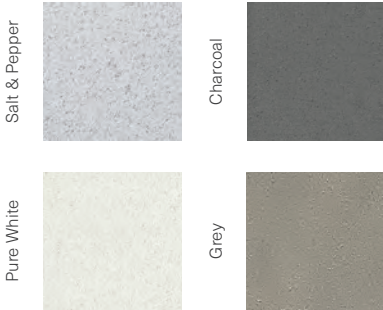

On order only →

All products in these colors are available on order only, in all finishes.

- 150 series All sizes  
200 series All sizes  
300 series All sizes  
450 series All sizes  
600 series All sizes  
900 series All sizes

\*Minimum order 2,000 SF. For orders under 2,000 SF, setup fees may apply. Please contact your local Commercial Sales Rep for project pricing and support.

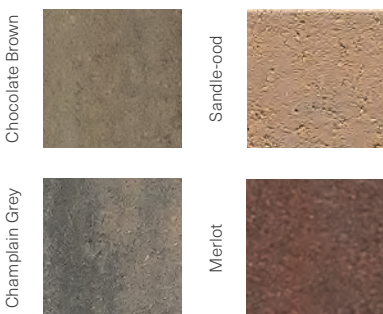

Dry Cast custom colors  
Available upon request

On order only →

All products in these colors are available on order only, in all finishes.

- 150 series All sizes  
200 series All sizes  
300 series All sizes  
450 series All sizes  
600 series All sizes  
900 series All sizes

\*Minimum order 4,000 SF. For orders under 4,000 SF, setup fees may apply. Please contact your local Commercial Sales Rep for project pricing and support.



INDUSTRIA FLORA

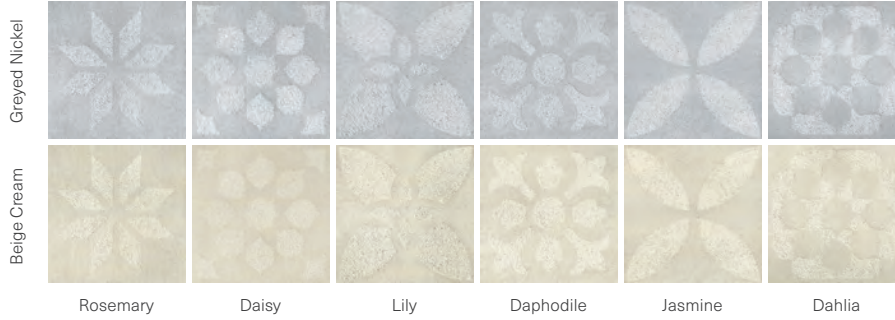

Flora Series

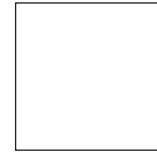

23 5/8 x 23 5/8 x 2 3/8 in  
600 x 600 x 60 mm

COLORS STUDIO

\*If interested in using another color, please contact your local Commercial Sales Rep for project pricing and support. A minimum project size of 5000 SF and a minimum order size of 500 SF per motif design is required to benefit from this service. Deposit is required.

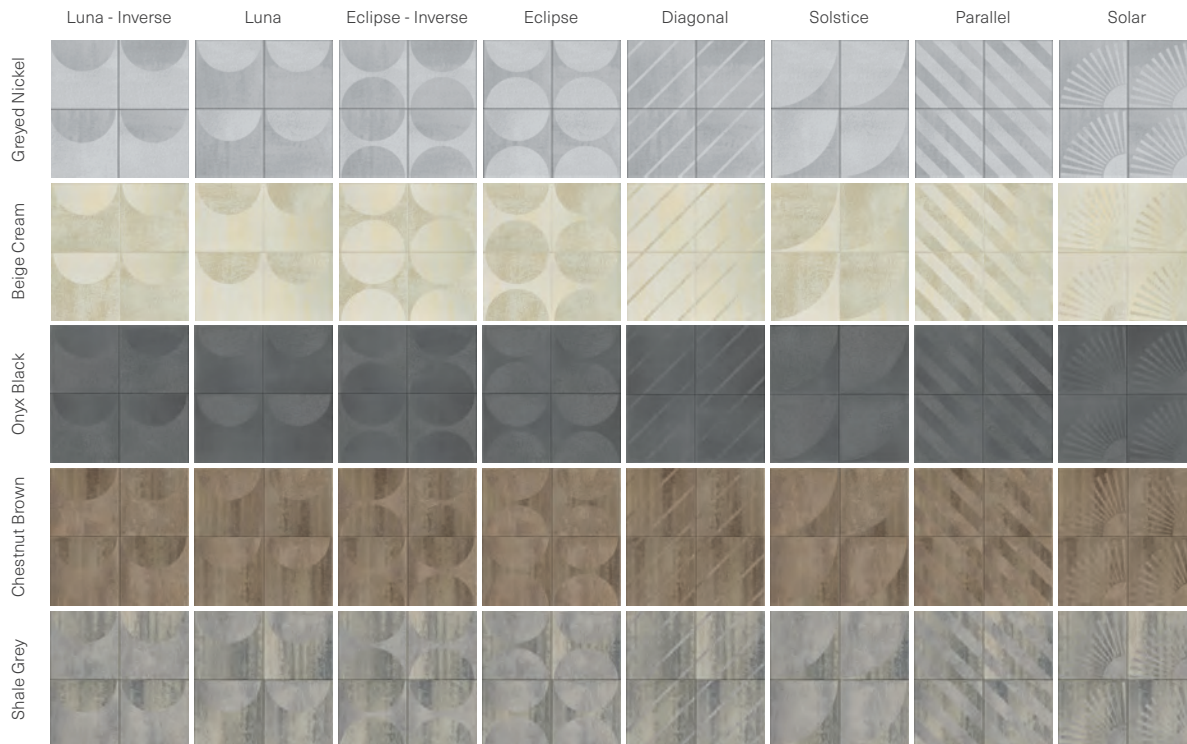

# THE ULTIMATE SALES TOOLS



Product selection made easy from the comfort of your client's home with Techo-Bloc's Mix & Match Kit, Sample Briefcase and Suitcase.



**CLOSE DEALS  
FASTER**



**TOP SELLING  
PRODUCT SAMPLES**



**HELP CLIENTS WITH  
PURCHASING PROCESS**



**EASY TO  
TRANSPORT**

Contact your local Techo-Bloc sales representative for details, or visit [www.techo-bloc.com/sample-books](http://www.techo-bloc.com/sample-books) to purchase your kit today!

**DISCOVER ALL  
THE TOOLS**



# TECHO — PRO

AN EXCLUSIVE CLUB  
FOR WORLD-CLASS  
LANDSCAPE CONTRACTORS.

Running a business is hard and growing a business is harder. Membership in Techo-Pro helps you grow your hardscaping business by offering a vast array of tools and support designed to give you an edge year after year.

## TAKE ADVANTAGE OF SPECIAL PERKS BASED ON 3 TIERS



### TRAIN AND EMPOWER YOUR CREW

- Build skills with Hardscaper.com courses
- Learn from on-demand workshops
- Stay inspired with the Hardscaper Podcast
- Stay inspired with the Hardscaper Podcast



### GENERATE MORE LEADS, WIN MORE JOBS

- Stand out to homeowners with a dedicated webpage to request quotes
- Receive detailed, high-quality leads directly to your inbox



### UNLOCK EXCLUSIVE PERKS

- Access exclusive partner and sales tool discounts
- Qualify for the Pave Now, Pay Later financing program
- Tap into our Pro-Only marketing assets and photo library
- Enjoy your annual Pro gift —branded merch, certificates and Pro IDs

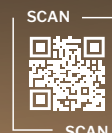

Become a  
Techo-Pro

# TYPICAL APPLICATION USAGE

## RESIDENTIAL



**Pedestrian:** Pedestrian areas at all times (e.g. patios, walkways)



**Residential driveway:** Driveway or area intended for residential vehicle access and parking (e.g., a private driveway to a home)

## COMMERCIAL



**Commercial Light:** Areas with access for private automobiles and occasional light delivery trucks, maintenance and emergency vehicles (e.g. public plaza, fire lane).



**Commercial Intermediate:** Areas mostly used by private automobiles, delivery trucks and occasional heavy vehicles (e.g. commercial/business parking).



**Commercial Occasional Heavy:** Areas where a limited number of heavy vehicles, such as garbage trucks, are anticipated daily (e.g. residential roadways/ local roads).



**Commercial Heavy:** Areas where heavy vehicles, such as buses, are a regular component of the daily traffic (e.g. crosswalks, collectors, arterials).

## Slabs







	THICKNESS (NOMINAL)		JOINT WIDTH		RESIDENTIAL		COMMERCIAL					PERMEABLE	GRASS (CONCRETE GRID) PAVER	INSTALLATION ON PEDESTAL SET	BITUMINOUS SAND-SET <sup>2</sup>	ADA <sup>3</sup>	MECHANICAL INSTALLATION <sup>6</sup>
	mm	in	mm	in													
Aberdeen 20×10 & 20×20 <sup>1</sup>	57	2 ¼	5	¾	x												
Aberdeen 30×20 <sup>1</sup>	57	2 ¼	5	¾	x												
Aberdeen 30×30 <sup>1</sup>	57	2 ¼	5	¾	x												
Blu 60 mm	60	2 ¾	7	½	x						x <sup>5</sup>				x <sup>4</sup>		x <sup>7</sup>
Blu 60 mm 6×13	60	2 ¾	7	½	x	x					x				x <sup>4</sup>		
Blu Grande	60	2 ¾	7	½	x								HD <sup>2</sup> only		x <sup>4</sup>		
Borealis 5×30 <sup>1</sup>	57	2 ¼	5	¾	x										x		
Borealis 10×30 <sup>1</sup>	57	2 ¼	5	¾	x										x		
Borealis stepping stones <sup>1</sup>	57	2 ¼	Variable		x												
Everest square 250×250	60	2 ¾	1,5	½	x	x	x										
Everest square 500×500	60	2 ¾	1,5	½	x								x				
Everest rectangle	60	2 ¾	1,5	½	x												
Hexa 60 mm	60	2 ¾	2,5	¾	x										x		x
Industria 600×600×60	60	2 ¾	3	½	x									x	x		
Industria 900×600×60	60	2 ¾	3	½	x												
Flora	60	2 ¾	3	½	x									x	x		
Maya <sup>1</sup>	57	2 ¼	Variable		x												
Para 500×250	60	2 ¾	1,5	½	x										x		
Para 500×500	60	2 ¾	1,5	½	x									x	x		
Para 500×750	60	2 ¾	1,5	½	x									x	x		
Raffinato 14"×28" (60 mm)	60	2 ¾			x												
Sandstone Various sizes	22	¾	10	¾	x										x		
Sandstone 50 mm	50	1 ¾	10	¾	x												
Terrazzo 600×150	60	2 ¾	3	½	x										x		
Terrazzo 600×300	60	2 ¾	3	½	x										x		
Terrazzo 600×600	60	2 ¾	3	½	x									x	x		
Travertina Raw 20×10 & 20×20 <sup>1</sup>	57	2 ¼	2	½	x										x		
Travertina Raw 20×30 <sup>1</sup>	57	2 ¼	2	½	x										x		
Travertina Raw 30×30 <sup>1</sup>	57	2 ¼	2	½	x										x		

### Notes:

- De-icing salt shall not be used on this product.
- Pavers on bituminous-sand set in vehicular applications require the thickness tolerance to be +/- 1/16 in. (1.5 mm).
- Meets the Americans with Disabilities Act (ADA) design guidelines for accessible paths:
  - Slip resistant paver surface
  - Paver joint openings do not allow the passage of a sphere greater than ½ in. (13 mm) in diameter
- Tumbled or embossed pavers could result on surfaces or edges unsuitable for ADA applications.
- For permeable application, the installation should be combined with Blu 6×13 in a modular pattern. A min. of 4.5% opening surface requires 75% of Blu 6×13 and 25% of Blu.
- Manufactured in a pre-arranged layout optimized for machine installation.
- Check with your local Techo-Bloc representative.

# TYPICAL APPLICATION USAGE

## Pavers

	THICKNESS (NOMINAL)		JOINT WIDTH		RESIDENTIAL		COMMERCIAL					PERMEABLE	GRASS (CONCRETE GRID) PAVER	INSTALLATION ON PEDESTAL SET	BITUMINOUS SAND-SET*	ADA <sup>3</sup>	MECHANICAL INSTALLATION <sup>6</sup>
	mm	in	mm	in													
Antika	60	2 3/8	Variable		x	x						x					
Aquastorm	100	3 15/16	41	1 1/8	x	x	x					x	x				
Blu 80 mm	80	3 1/8	7	9/32	x	x	x					x <sup>5</sup>			x	x <sup>4</sup>	
Blu 80 mm (6x13)	80	3 1/8	7	9/32	x	x	x	x				x			x	x <sup>4</sup>	
Diamond	100	3 15/16	2,5	3/32	x	x	x	x	x						x	x	x
Eva	60	2 3/8	3	1/8	x	x											
Hexa 100 mm	100	3 15/16	2,5	3/32	x	x	x	x							x	x	x
Hydra	100	3 15/16	13	1/2	x	x	x	x	x		x					x	x
Industria 150x150	100	3 15/16	3	1/8	x	x	x	x	x						x	x	
Industria 200x200	100	3 15/16	3	1/8	x	x	x	x	x						x	x	
Industria 200x400	100	3 15/16	3	1/8	x	x	x	x							x	x	
Industria 300x100	100	3 15/16	3	1/8	x	x	x	x	x	x					x	x	
Industria 300x150	100	3 15/16	3	1/8	x	x	x	x	x	x					x	x	
Industria 300x300	100	3 15/16	3	1/8	x	x	x	x	x						x	x	
Industria 450x100	100	3 15/16	3	1/8	x	x									x	x	
Industria 450x150	100	3 15/16	3	1/8	x	x	x								x	x	
Industria 450x300	100	3 15/16	3	1/8	x	x	x	x							x	x	
Industria 600x100	100	3 15/16	3	1/8	x										x	x	
Industria 600x200	100	3 15/16	3	1/8	x	x	x								x	x	
Industria 600x300	100	3 15/16	3	1/8	x	x	x								x	x	
Industria 600x600	100	3 15/16	3	1/8	x	x	x								x	x	
Industria 900x300	100	3 15/16	3	1/8	x	x										x	
Industria 900x600	100	3 15/16	3	1/8	x	x										x	
Industria 900x900	100	3 15/16	3	1/8	x	x										x	
Industria Tactile	100	3 15/16	3	1/8	x	x	x	x	x						x	x	
Industria Triangle	100	3 15/16	3	1/8	x	x	x	x							x	x	
Linea small rectangles	100	3 15/16	3	1/8	x	x	x								x	x	x
Linea larges rectangles	100	3 15/16	3	1/8	x	x	x								x	x	x
Mika	70	2 3/4	15	5/8	x	x	x				x						
Mista random	65	2 9/16	4-14	3/16-9/16	x	x					x						
Oxford	70	2 3/4	10	3/8	x	x	x	x			x						
Pure	80	3 1/8	10	13/32	x	x	x	x			x						
Sleek	90	3 9/16	2,5 or 4,0	3/32 or 5/32	x	x								x		x	
Squadra	60	2 3/8	4	5/32	x	x	x										
Terrazzo 300x150	60	2 3/8	3	1/8	x	x											
Valet	60	2 3/8	7	9/32	x	x	x				x				x		
Victorien 60 mm	60	2 3/8	3	1/8	x	x	x								x	x	
Villagio	60	2 3/8	9-15	3/8-9/16	x	x	x				x						
Westmount	80	3 1/8	3	1/8	x	x	x								x	x	

### Notes:

- De-icing salt shall not be used on this product.
- Pavers on bituminous-sand set in vehicular applications require the thickness tolerance to be +/- 1/16 in. (1.5 mm).
- Meets the Americans with Disabilities Act (ADA) design guidelines for accessible paths:
  - Slip resistant paver surface
  - Paver joint openings do not allow the passage of a sphere greater than 1/2 in. (13 mm) in diameter
- Tumbled or embossed pavers could result on surfaces or edges unsuitable for ADA applications.
- For permeable application, the installation should be combined with Blu 6x13 in a modular pattern. A min. of 4.5% opening surface requires 75% of Blu 6x13 and 25% of Blu.
- Manufactured in a pre-arranged layout optimized for machine installation.
- Check with your local Techo-Bloc representative.

# INSTALLATION GUIDE

## PAVING UNIT ON COMPACTED GRANULAR BASE

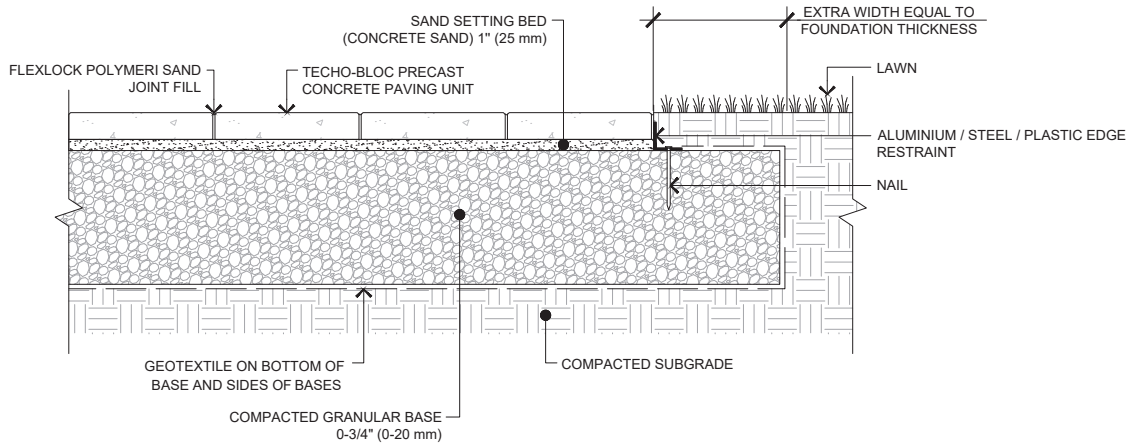

## PAVING UNIT ON PEDESTAL SET

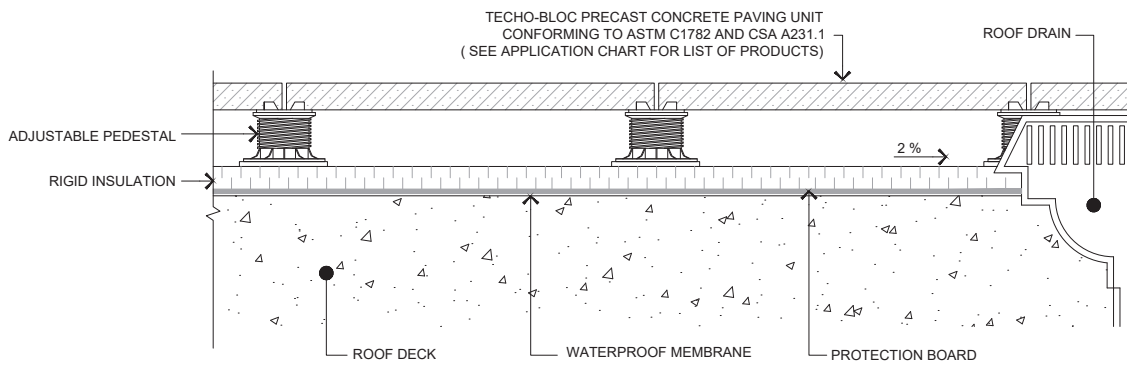

# INSTALLATION GUIDE

## CONCRETE GRID PAVER - AQUASTORM (GRASS INFILL)

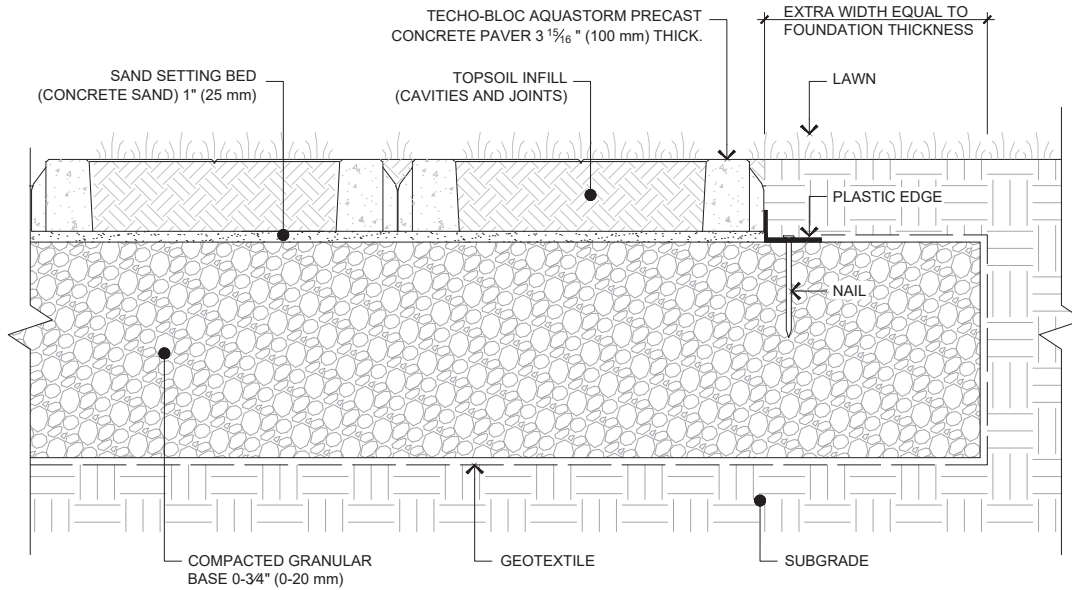

## CONCRETE GRID PAVER - AQUASTORM (AGGREGATE INFILL)

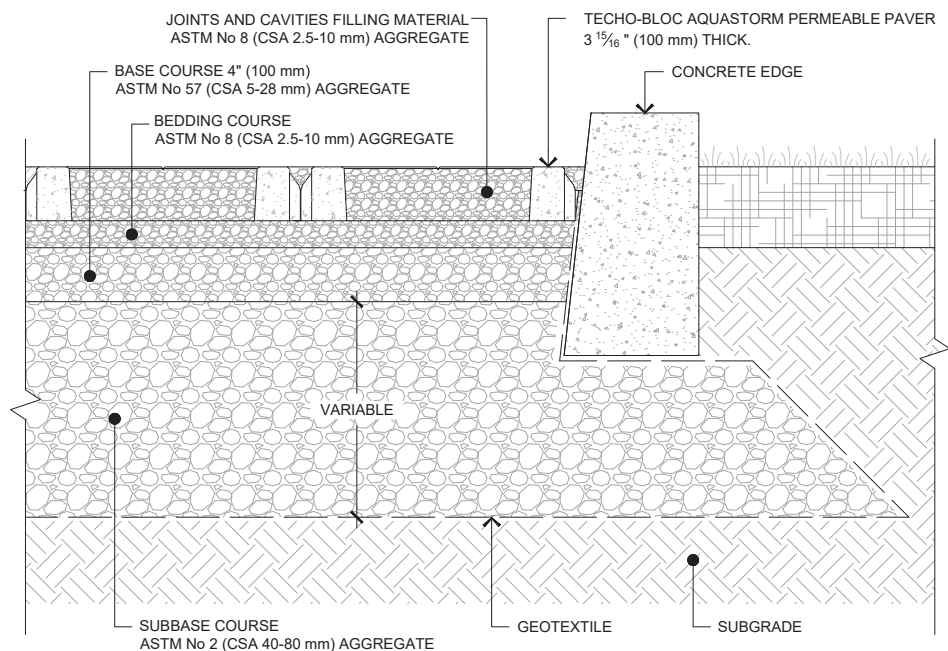

# INSTALLATION GUIDE

## PERMEABLE PAVER - FULL INFILTRATION TO SOIL SUBGRADE

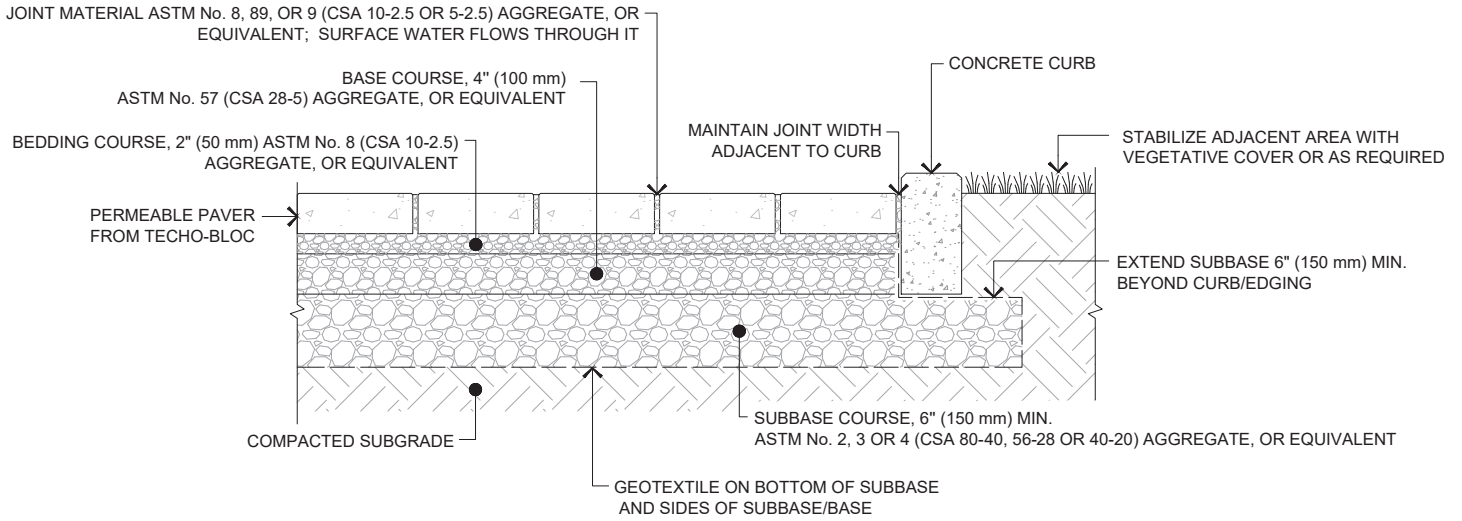

## PERMEABLE PAVER - PARTIAL INFILTRATION TO SOIL SUBGRADE

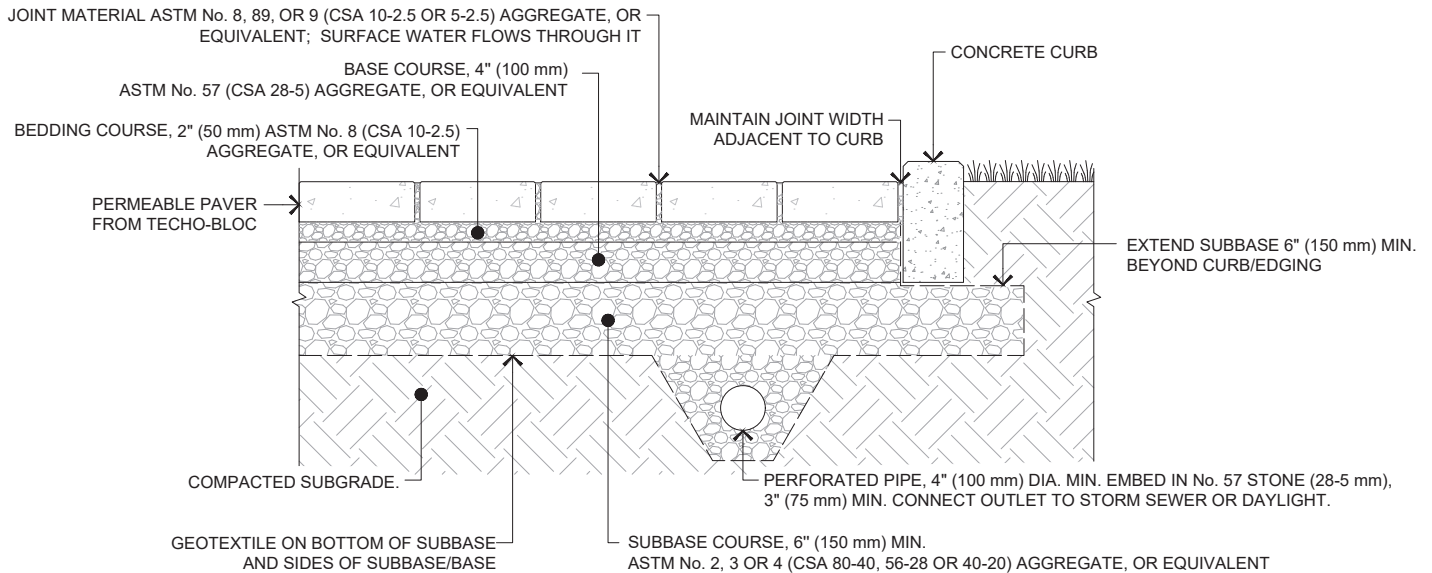

# INSTALLATION GUIDE

## PERMEABLE PAVER - NO INFILTRATION TO SOIL SUBGRADE

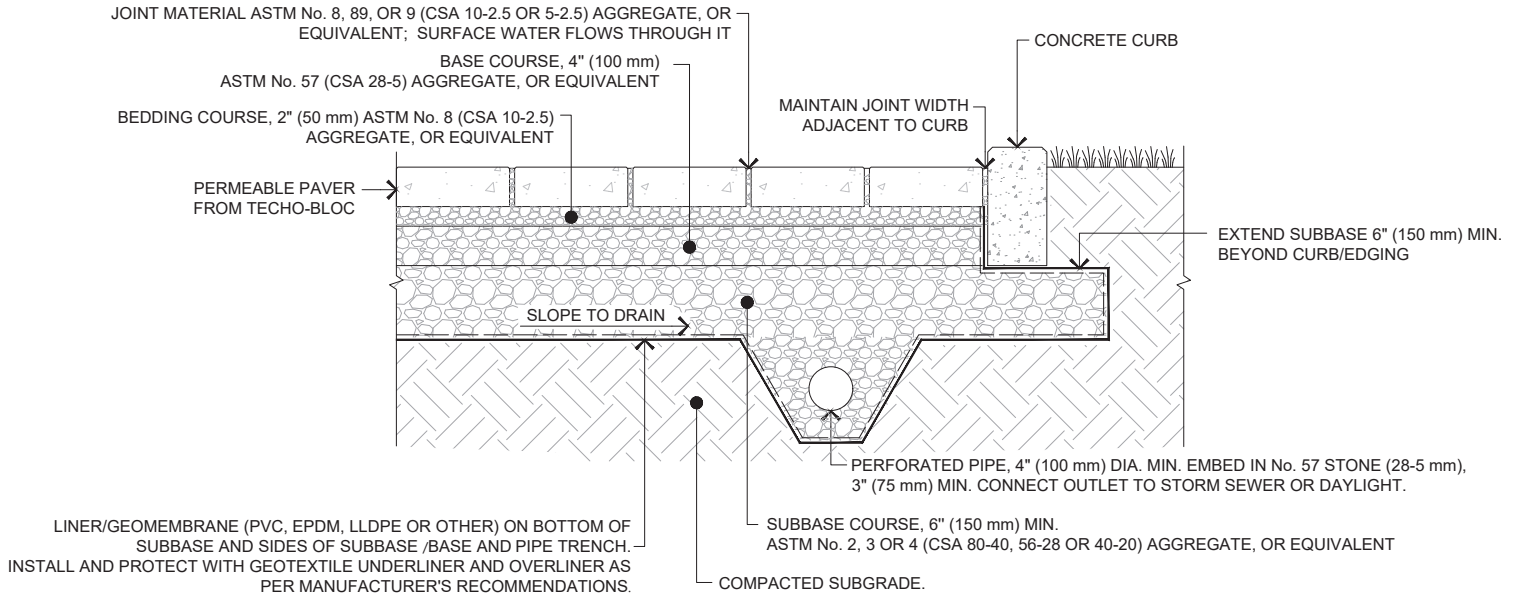

## NATURAL STONE PAVING UNITS MORTAR BEDDING OVER CONCRETE

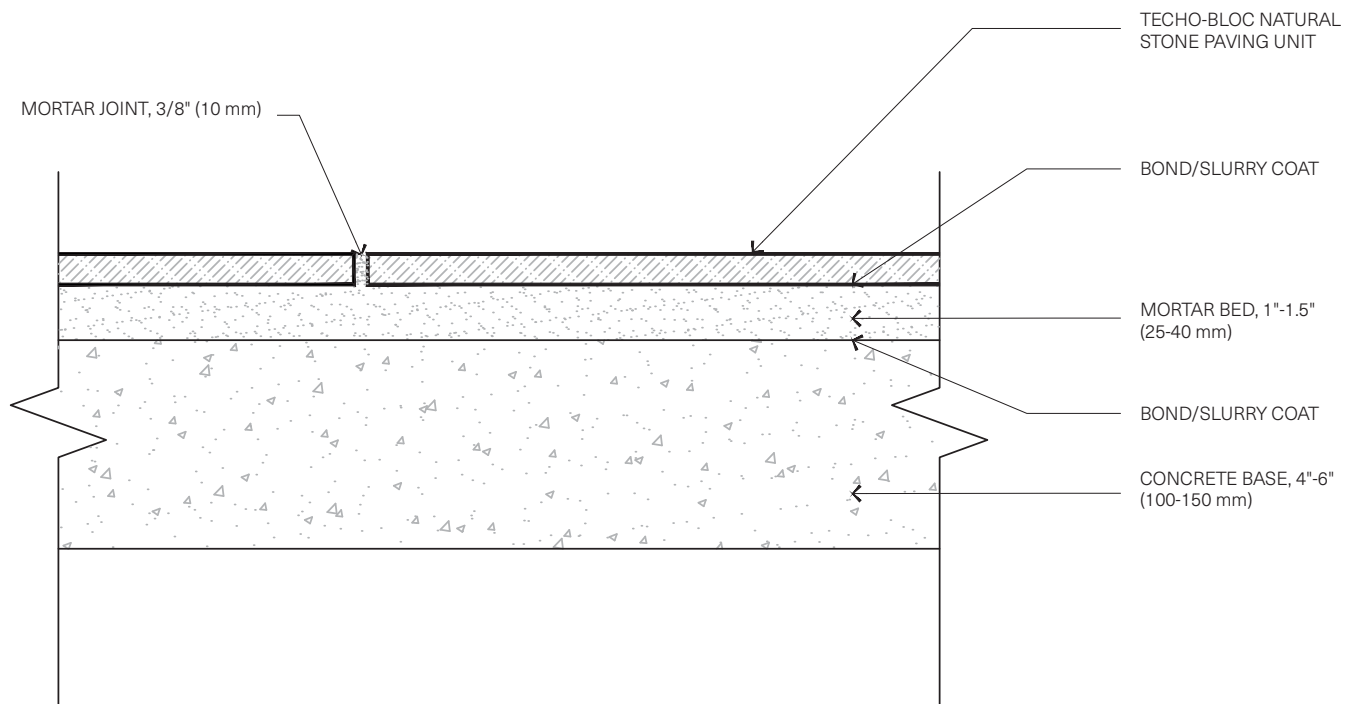

## INSTALLATION GUIDE

### NATURAL STONE PAVING UNITS MORTAR BEDDING OVER GRANULAR BASE

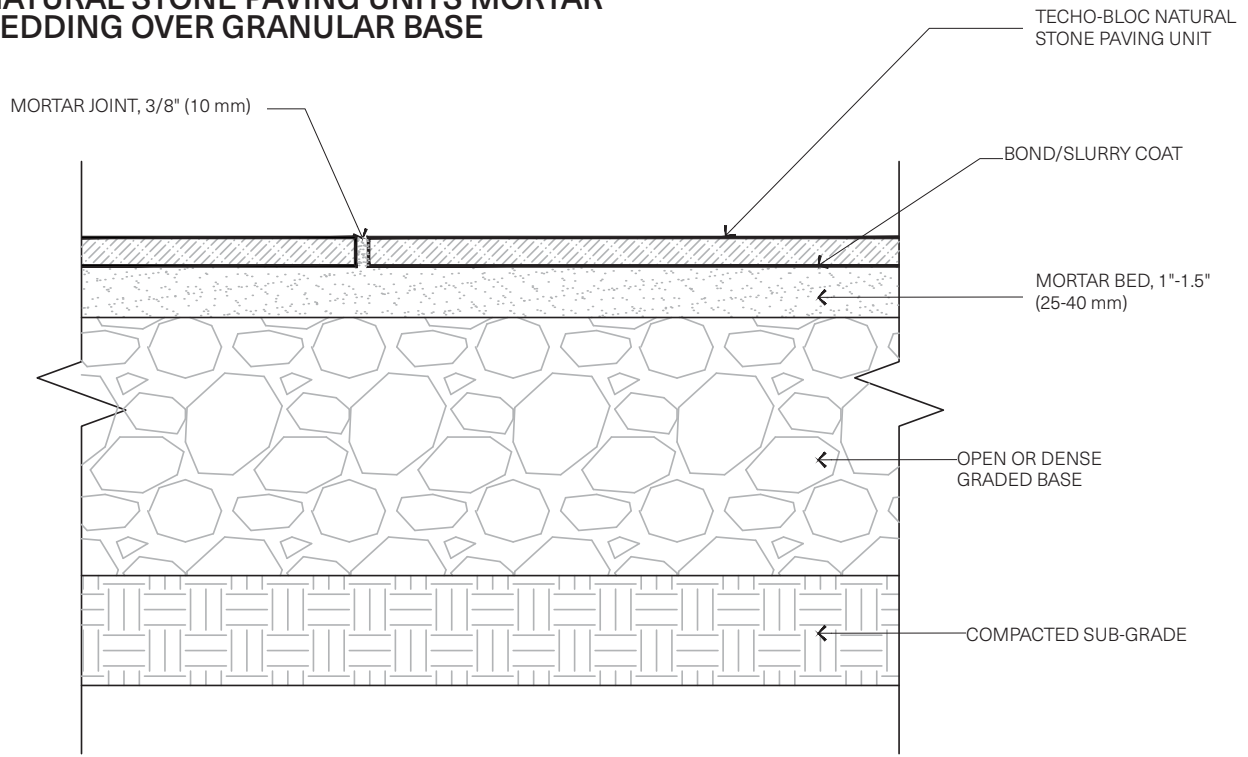

# INSTALLATION ACCORDING TO NOMINAL DIMENSIONS

The nominal dimension of a paving unit (width or length) represents the absolute distance between the half-joint on one side of the paving unit and the half-joint on the opposite side. The paving units must be laid while respecting their nominal dimensions. Installed pavers must be neither too tight nor too loose to ensure the performance and integrity of the pavement in service.

Here is an example where pavers of nominal dimension 600x100 mm are laid next to 600x300 mm pavers. If the installation is done according to the nominal dimensions (mid-joint to mid-joint), then at each 600 mm the ends of the pavers will coincide. Otherwise, the installation will be considered tight or loose.

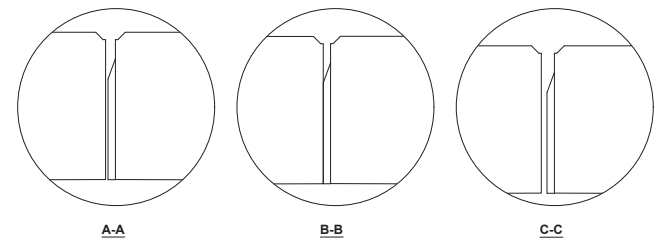
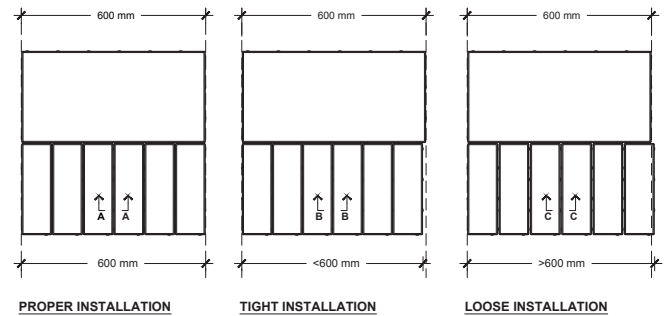

## PAVING UNITS – JOINT WIDTH

The space between the paving units (excluding the spacer), i.e. the joint width (J), will depend on the thickness of the spacer (T) and the free space (e) between the spacer and the edge side (or spacer) of the adjacent paving unit. To these dimensions are added the dimensions of the chamfer (Ch) and flat shoe (Cf) to determine the joint width on the surface (Js) of the segmental concrete pavement.

Note: The dimensions shown in this table can differ for paving units with slate texture or other type of embossed texture. SLEEK joint width will depend on the spacer position: (i) front to front (largest dimension) or (ii) staggered (smallest dimension).

PAVER	HEIGHT		NOMINAL JOINT WIDTH (J)		JOINT WIDTH ON THE SURFACE (JS)		CHAMFER			SPACER	
	H		J1	J2	Js1	Js2	Cf	Cv	Ch	T	e
Aquastorm	100 mm	3 5/8 in.	41.0 mm	-	49.0 mm	-	1.0 mm	3.0 mm	3.0 mm	20.0 mm	1.0 mm
Blu 80 (6x13)	80 mm	3 1/8 in.	7.0 mm		15.0 mm	-	1.0 mm	3.0 mm	3.0 mm	3.0 mm	1.0 mm
Hexa 100 mm	100 mm	3 5/8 in.	2.5 mm	-	7.5 mm		1.0 mm	1.5 mm	1.5 mm	1.5 mm	1.0 mm
Industria	100 mm	3 5/8 in.	3.0 mm	-	11.0 mm	-	1.0 mm	3.0 mm	3.0 mm	2.0 mm	1.0 mm
Linea	100 mm	3 5/8 in.	3.0 mm	-	11.0 mm	-	1.0 mm	3.0 mm	3.0 mm	2.0 mm	1.0 mm
Diamond	100 mm	3 5/8 in.	2.5 mm	-	7.5 mm	-	1.0 mm	1.5 mm	1.5 mm	1.5 mm	1.0 mm
Sleek	90 mm	3 3/8 in.	4.0 mm	2.5 mm	12.0 mm	10.5 mm	1.0 mm	3.0 mm	3.0 mm	1.5 mm	1.0 mm
Westmount	80 mm	3 1/8 in.	3.0 mm		43.0 mm		0.0 mm	1.0 mm	20.0 mm	2.0 mm	1.0 mm
Hydra	100 mm	3 5/8 in.	13.0 mm	-	19.0 mm	-	1.0 mm	3.0 mm	3.0 mm	12.0 mm	1.0 mm
Pure	80 mm	3 1/8 in.	10.0 mm	-	Variable		Variable	7.0 mm	Variable	9.0 mm	1.0 mm

### LEGEND

- H HEIGHT
- Js JOINT WIDTH ON THE SURFACE
- J JOINT WIDTH BETWEEN TWO PAVERS (excluding spacers)
- Cf FLAT SHOE CHAMFER
- Cv CHAMFER VERTICAL RISE
- Ch CHAMFER HORIZONTAL DISTANCE
- T THICKNESS OF SPACERS
- e FREE SPACE BETWEEN THE PAVER'S SPACER AND ADJACENT PAVER

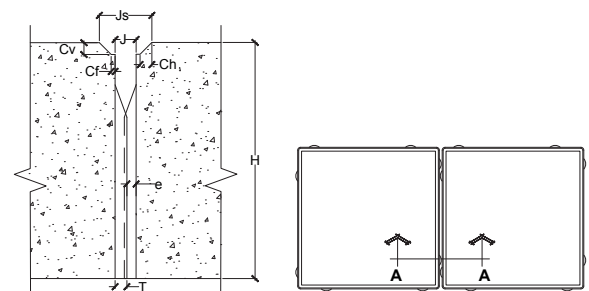

Typical Paver Joint

# SLABS

PATIOS, WALKWAYS, POOLSIDES & STEPPING STONES

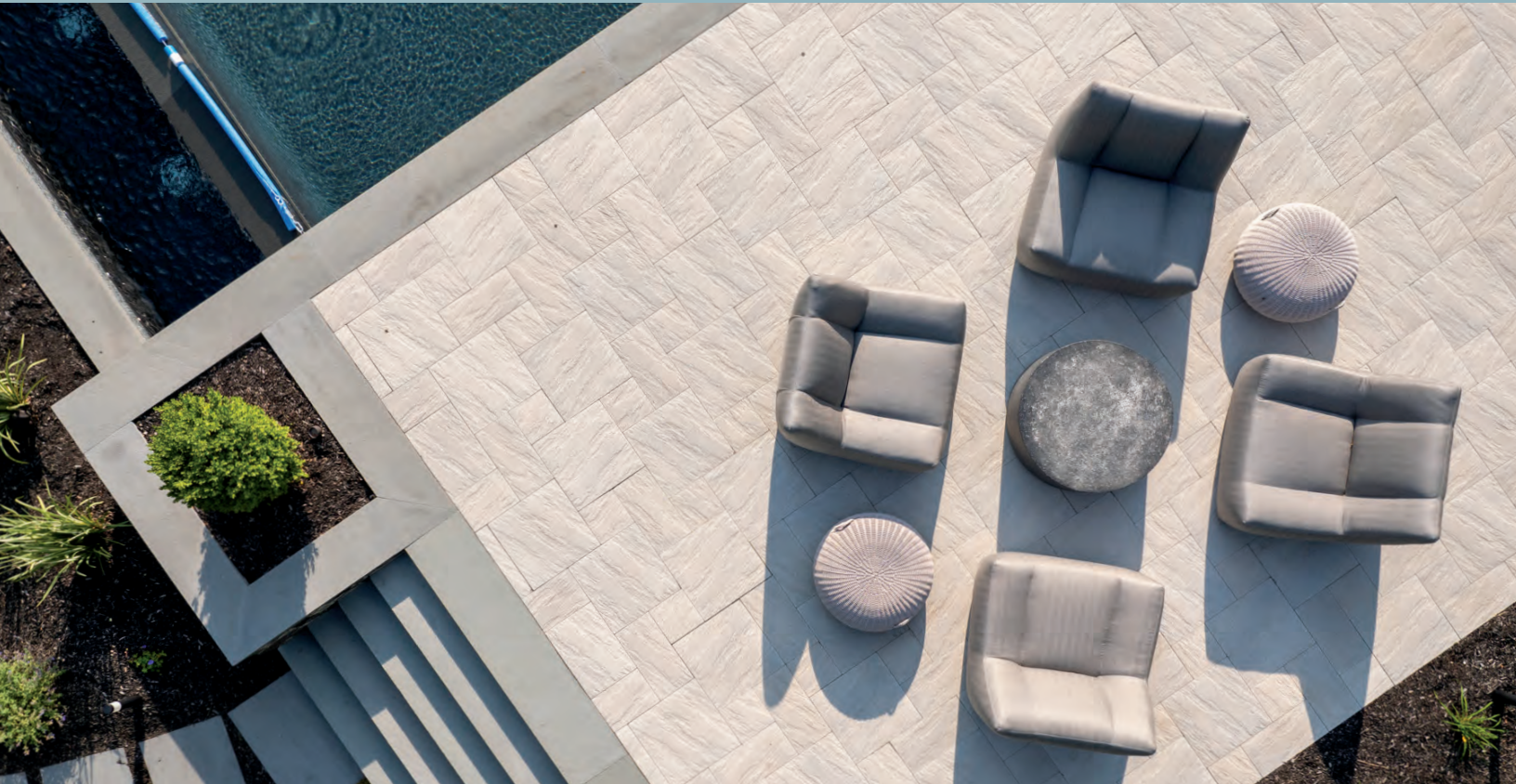

Aberdeen	P. 37	Industria 600 Series	P. 52
Blu 60 mm	P. 39	Maya Stepping Stone	P. 54
Borealis	P. 47	Para	P. 55
Borealis Stepping Stone	P. 48	Sandstone	P. 57
Everest	P. 49	Terrazzo	P. 58
Hexa	P. 51	Travertina Raw	P. 60

## PHYSICAL AND GEOMETRICAL CHARACTERISTICS

CHARACTERISTICS		ASTM C1782	CSA A231.1:19
Flexural strength		725 psi [5.0 MPa]	5.0 MPa min.
Freeze-thaw durability		Mass loss (max.): 225 g/m <sup>2</sup> at 28 cycles, or Mass loss (max.): 500 g/m <sup>2</sup> at 49 cycles	Mass loss (max.): 225 g/m <sup>2</sup> after 28 cycles, or Mass loss (max.): 500 g/m <sup>2</sup> after 49 cycles
Dimensional tolerances (see Notes below):	Length & Width	Units up to and including 24 in. [610 mm]: -0.04 in. [1.0 mm] and +0.08 in. [2.0 mm] Units over 24 in. [610 mm]: -0.06 in. [1.5 mm] and +0.12 in. [3.0 mm]	-1.0 mm to +2.0 mm
	Thickness	± 0.12 in. [3.0 mm]	± 3.0 mm
	Warpage	± 0.08 in. [2.0 mm] (Units up to and including 17.75 in. [450 mm])	± 2.0 mm (Units up to and including 450 mm)
± 0.12 in. [3.0 mm] (Units over 17.75 in. [450 mm])		± 3.0 mm (Units over 450 mm)	

Notes:

1. The dimensional tolerances shown above are prior to the application of architectural finishes.
2. The dimensional tolerances (length, width, thickness, and warpage) stated above apply for dry cast slabs only. In order to obtain a more realistic appearance to natural stone, wet cast (Stonedge collection) slabs are intended to have a slightly larger variance in their dimensions than dry cast slabs. Stonedge collection of wet cast slabs include, but are not limited to, the following products: Aberdeen, Borealis, Inca, Maya and Travertina Raw.

# INSTALLATION GUIDE

## SLABS

### INSTALLATION OUTLINE

#### 01 EXCAVATION

- A. Before excavating, call all the local utility companies (e.g., phone, gas, electrical) to ensure that the area in which you plan to dig is clear of underground cables or wires. If any are found, please notify the appropriate companies before you continue.
- B. When excavating, it is important to achieve a slope in increments of  $\frac{3}{8}$ " per ft (5 mm per 300 mm) which will allow for proper drainage. The excavation should mirror final grade of pavement.
- C. The width of the base behind the edge should be equivalent to the thickness of the base.
- D. With the help of a rake, grade the bottom of the excavated area. If the natural soil is granular or sandy we recommend that you compact the soil with a vibrating plate. If the soil is clay-like, change the soil with a blend of lime and crushed stone prior to compaction. Next, cover it with a layer of geotextile membrane to prevent the contamination of the base (clay and 0- $\frac{3}{4}$ " [0-20 mm] crushed stone). Refer to the table "**Thickness of the Granular Foundation**" (on next page) to find the minimum thickness of foundation required.

#### 02 FOUNDATION

- A. Install the 0- $\frac{3}{4}$ " (0-20 mm) crushed stone base in 4" (100 mm) lifts with a minimum 5,000 lbf (22 kN) vibrating plate compactor.
- B. To facilitate compacting, wet the base material thoroughly and compact with a vibrating plate proceeding in all directions. Continue this process until you achieve the desired height. At this stage, you can verify the final height with the help of a paver.
- C. Base tolerance  $\pm \frac{3}{8}$ " (10 mm) for every 10' (3-m) increment.

#### 03 THE SETTING BED

- A. On the compacted crushed base, install two pipes with an outside diameter of 1" (25 mm). Grade the concrete sand with the help of a straight edge (or Quick-E leveler). If the base isn't properly graded and smooth, imperfections will be evident in the finishing grade of the pavement.
- B. Once the setting bed is graded, pre-compact with a hand tamper, then lightly fluff.

#### 04 INSTALLATION OF SLABS

- A. Once the choice of slabs and the design have been finalized, it is recommended you start installing the slabs at a 90-degree angle. To obtain a 90-degree angle, use the rule of a 3 / 4 / 5-triangle. To do this, proceed as follows: measure a first horizontal line of 3' (1-m) and a second line of 4' (1.2 m) perpendicular to the first. Connect a third straight line of 5' (1.5 m), which will form a triangle, and the result will be a perfect 90-degree angle. While installing the slabs, walk on the installed slabs and fill in gaps caused by the pipes with concrete sand.
- B. It is always recommended that you use more than two cubes at a time in order to maximize the color blends. Furthermore, you should proceed with the cubes from top to bottom.
- C. You may use a chalk line to mark the stones to be cut along the borders, using a concrete saw. When cutting slabs, we recommend you wear protective ear and eyewear.
- D. Once you finish installing the slabs, you can then install Belgik, Pietra, Tundra, or Avignon curbstone. To keep curbs in place, add mortar along the back between the ground and the curbstone or, when available, use their plastic retention systems.

#### 05 FILLING IN JOINTS

- A. Spread out the polymer stabilizer sand on the slabs, and sweep in between joints in all directions.
- B. Remove excess sand and follow the instructions exactly as indicated on the polymer stabilizer sand packaging.
- C. The use of a vibrating plate is not recommended on slabs.

# INSTALLATION GUIDE

## SLABS



### VIBRATING PLATE ALERT!

We do not recommend passing the vibrating plate on slabs.

#### THICKNESS OF THE GRANULAR FOUNDATION<sup>1</sup>

RESIDENTIAL PROJECTS	TYPE OF EXISTING SOIL	
	Clayey or Silty <sup>2</sup>	Sandy or Gravelly
<b>Patios and Walkways</b>	6" to 8" (150 to 200 mm) Minimum	4" to 6" (100 to 150 mm) Minimum

1. Data shown in this chart are provided as guidelines only. The range of values suggested depends particularly on existing soil conditions. The thicker the granular foundation, the greater the increase in stability of the whole structure.
2. In the case of unstable soils or ones particularly affected by the freeze-thaw cycles, a thicker foundation may be necessary. For soils with these conditions or for commercial, industrial, or institutional works, a geotechnical professional should be consulted.

#### QUANTITY CHART FOR JOINTS FILLING - FLEXLOCK POLYMERIC SAND

Approximate surface coverage per bag of 50 lbs (22.7 kg).

SLABS	size	sq. ft	sq. m
<b>Aberdeen</b>	30 × 30	483	44.87
	30 × 20	388	36.05
	20 × 20	324	30.07
	20 × 10	216	20.08
<b>Blu 60 mm</b>		90.2	8.37
<b>Blu 60 mm (6"×13")</b>		42.63	3.96
<b>Blu Grande</b>	60 × 495 × 825	118.49	11.01
<b>Blu 45 mm</b> see Overlay section		93	9.5
<b>Borealis</b>	5 × 30	124.64	11.58
	10 × 30	233.03	21.65
<b>Borealis Stepping Stone</b>	Variable		
<b>Everest</b>	250 × 250	179	16.63
	250 × 500	223	20.00
	500 × 500	336	31.00

SLABS	size	sq. ft	sq. m
<b>Hexa 60 mm</b>		101.2	9.40
<b>Industria 600 series</b>	600 × 600 × 60	204.13	18.96
	900 × 600 × 60	261	24.3
<b>Flora</b>	600 × 600 × 60	204.13	18.96
<b>Maya</b>	Variable		
<b>Para</b>	500 × 250	223	20
	500 × 500	336	31
	500 × 750	405	37
<b>Terrazzo</b>	600 × 150	132.8	12.35
	600 × 300	195.7	18.19
	600 × 600	256.4	23.84
<b>Travertina Raw</b>	30 × 30	483	44.87
	30 × 20	388	36.05
	20 × 20	324	30.07
	20×10	216	20.08





# ABERDEEN

DESCRIPTION: Slab TEXTURE: Klean-Bloc Slate

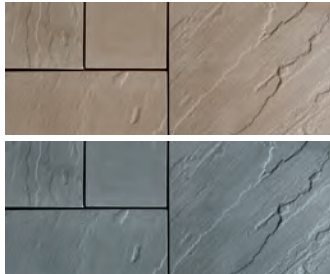
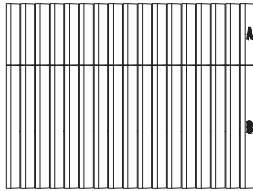
## Pallet Overview - 20" x 10" and 20" x 20"



Klean-Bloc Slate  
Rock Garden Brown  
Klean-Bloc Slate  
Azurro

20" x 10" - 20" x 20"		Imperial	Metric
<b>Specifications per pallet</b>			
<b>A</b>		Product dimension (L x W x H) <b>A</b> 10 x 20 x 2 1/4	254 x 508 x 57
		Product dimension (L x W x H) <b>B</b> 20 x 20 x 2 1/4	508 x 508 x 57
	17 units / pallet	Cubing	70.83 ft <sup>2</sup> 6.58 m <sup>2</sup>
<b>B</b>		Approx. Weight	1 789 lbs 811 kg
		Number of rows	1
	17 units / pallet	Coverage per unit <b>A</b>	1.39 ft <sup>2</sup> 0.13 m <sup>2</sup>
		Coverage per unit <b>B</b>	2.78 ft <sup>2</sup> 0.26 m <sup>2</sup>
		Lin. coverage per row	42.5 lin. ft 12.95 lin. m

## Laying Patterns Options

01 | Modular

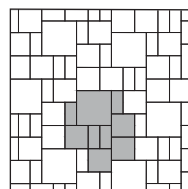

02 | Modular

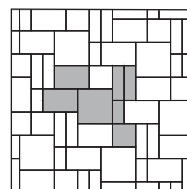

03 | Modular

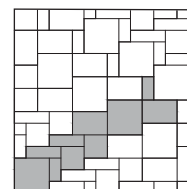

04 | Modular

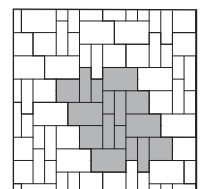

Patterns are for design inspiration only. The installer is responsible to calculate & purchase the correct amount of material.

## NOTES

Palletized upright.

See page 6 for icons description.

See page 26 for more information about applications.

See page 34 to 36 for more technical information.

\*For an authentic look, each color option is composed of a variety of darker & lighter tones. Natural ingredients such as granite are present within the recipe to allow for a range in tones, veining and textures from one stone to another.

Please note that for barefoot walking areas (e.g. pool deck) dark-colored paving units could get very hot under the sun.



# ABERDEEN

DESCRIPTION: Slab TEXTURE: Klean-Bloc Slate

30" x 20"		Imperial	Metric
<b>Specifications per pallet</b>			
	Product dimension (L x W x H)	20 x 30 x 2 1/4	508 x 762 x 57
	Cubing	70.83 ft <sup>2</sup>	6.58 m <sup>2</sup>
17 units / pallet	Approx. Weight	1 796 lbs	815 kg
	Number of rows	1	
	Coverage per unit	4.17 ft <sup>2</sup>	0.39 m <sup>2</sup>
Lin. coverage per row	Depth	42.5 lin. ft	12.95 lin. m
	Length	28.3 lin. ft	8.63 lin. m

30" x 30"		Imperial	Metric
<b>Specifications per pallet</b>			
	Product dimension (L x W x H)	30 x 30 x 2 1/4	762 x 762 x 57
	Cubing	106.25 ft <sup>2</sup>	9.87 m <sup>2</sup>
17 units / pallet	Approx. Weight	2 610 lbs	1 184 kg
	Number of rows	1	
	Coverage per unit	6.25 ft <sup>2</sup>	0.58 m <sup>2</sup>
Lin. coverage per row	Depth	42.5 lin. ft	12.95 lin. m
	Length	28.3 lin. ft	8.63 lin. m

Pallet Overview - 30" x 20"

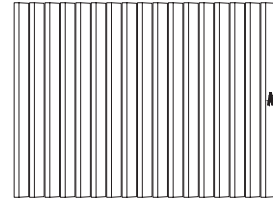

Pallet Overview - 30" x 30"

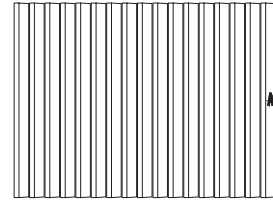

Rock Garden Brown

Klean-Bloc Slate



Azzurro

Klean-Bloc Slate

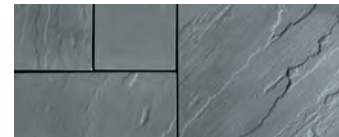

## Laying Patterns Options

05 | Modular

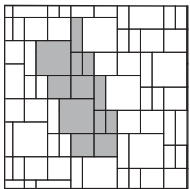

06 | Modular

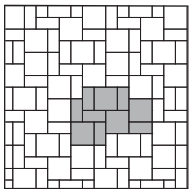

07 | Linear

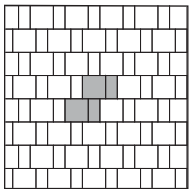

08 | Linear

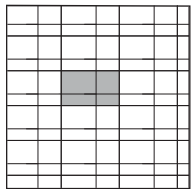

Patterns are for design inspiration only. The installer is responsible to calculate & purchase the correct amount of material.

## NOTES

Palletized upright.

See page 6 for icons description.

See page 26 for more information about applications.

See page 34 to 36 for more technical information.

\*For an authentic look, each color option is composed of a variety of darker & lighter tones. Natural ingredients such as granite are present within the recipe to allow for a range in tones, veining and textures from one stone to another.

Please note that for barefoot walking areas (e.g. pool deck) dark-colored paving units could get very hot under the sun.



# BLU 60 mm

DESCRIPTION: Slab TEXTURE: Slate and HD² Slate

## Pallet Overview

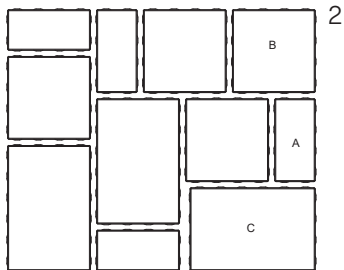
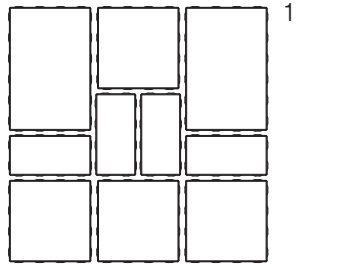

HD² Slate\*\*  
Slate  
Chestnut Brown



Slate  
Sandalwood





HD² Slate\*\*  
Slate  
Champlain Grey





HD² Slate\*\*  
Slate  
Shale Grey

## Specifications per pallet<sup>1</sup>

	Imperial	Metric
<b>A</b>  Product dimension (L x W x H) <b>A</b>	6 1/2 x 13 x 2 3/8	165 x 330 x 60
44 units / pallet		
<b>B</b>  Product dimension (L x W x H) <b>B</b>	13 x 13 x 2 3/8	330 x 330 x 60
44 units / pallet		
<b>C</b>  Product dimension (L x W x H) <b>C</b>	19 1/2 x 13 x 2 3/8	495 x 330 x 60
22 units / pallet		
Cubing	116.82 ft <sup>2</sup>	10.96 m <sup>2</sup>
Approx. Weight slate	3 148 lbs	1 428 kg
Approx. Weight HD² Slate	3 268 lbs	1 482 kg
Number of rows	11	
Coverage per row	10.62 ft <sup>2</sup>	0.99 m <sup>2</sup>
Lin. coverage per row	9.81 lin. ft	3.02 lin. m

## Specifications per pallet<sup>2</sup> (Only Available in Eastern USA)

	Imperial	Metric
<b>A</b>  Product dimension (L x W x H) <b>A</b>	6 1/2 x 13 x 2 3/8	165 x 330 x 60
44 units / pallet		
<b>B</b>  Product dimension (L x W x H) <b>B</b>	13 x 13 x 2 3/8	330 x 330 x 60
44 units / pallet		
<b>C</b>  Product dimension (L x W x H) <b>C</b>	19 1/2 x 13 x 2 3/8	495 x 330 x 60
33 units / pallet		
Cubing	135.39 ft <sup>2</sup>	12.58 m <sup>2</sup>
Approx. Weight HD² Slate	3 779 lbs	1 714 kg
Number of rows	11	
Coverage per row	12.31 ft <sup>2</sup>	1.14 m <sup>2</sup>
Lin. coverage per row	11.37 lin. ft	3.47 lin. m

<sup>2</sup>New packaging HD² Slate - Available after depletion of original packaging

## MECHANICAL INSTALLATION<sup>2</sup>

### Step 1

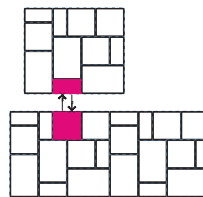

### Step 2

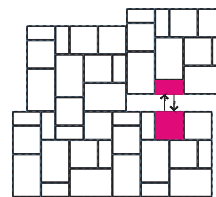

### Step 3

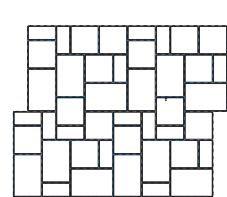

Clamp or Mechanical tool available for machine installation. Check with your local Techo-Bloc representative for more information.

## NOTES

See page 6 for icons description.

See page 26 for more information about applications.

See page 34 to 36 for more technical information. When used in a permeable pavement application, see page 100 to 110 for more technical information.

Please note that for barefoot walking areas (e.g. pool deck) dark-colored paving units could get very hot under the sun.

**JOINT WIDTH:** 5/32" (7 mm)  
**% OF SURFACE OPENING:** 4.5%\*  
**INFILTRATION RATE:** 570 in./hr (14 475 mm/hr)

\*For permeable application, the installation should be combined with Blu 6 x 13 in a modular pattern. A min. of 4.5% opening surface requires 75% of Blu 6 x 13 and 25% of Blu.



\*\*HD² Slate is only available in USA.





# BLU 60 mm

DESCRIPTION: Slab TEXTURE: Smooth and HD<sup>2</sup> Smooth



Specifications per pallet <sup>1</sup>		Imperial	Metric
<b>A</b> 	Product dimension (L x W x H) <b>A</b>	6 1/2 x 13 x 2 3/8	165 x 330 x 60
	Product dimension (L x W x H) <b>B</b>	13 x 13 x 2 3/8	330 x 330 x 60
	Product dimension (L x W x H) <b>C</b>	19 1/2 x 13 x 2 3/8	495 x 330 x 60
44 units / pallet	Cubing	116.82 ft <sup>2</sup>	10.96 m <sup>2</sup>
<b>B</b> 	Approx. Weight Smooth	3 170 lbs	1 438 kg
	Approx. Weight HD <sup>2</sup> Smooth	3 295 lbs	1 495 kg
<b>C</b> 	Number of rows	11	
	Coverage per row	10.62 ft <sup>2</sup>	0.99 m <sup>2</sup>
	Lin. coverage per row	9.81 lin. ft	3.02 lin. m

Specifications per pallet <sup>2</sup> <small>(Only Available in Eastern USA and Canada)</small>		Imperial	Metric
<b>A</b> 	Product dimension (L x W x H) <b>A</b>	6 1/2 x 13 x 2 3/8	165 x 330 x 60
	Product dimension (L x W x H) <b>B</b>	13 x 13 x 2 3/8	330 x 330 x 60
	Product dimension (L x W x H) <b>C</b>	19 1/2 x 13 x 2 3/8	495 x 330 x 60
44 units / pallet	Cubing	135.39 ft <sup>2</sup>	12.58 m <sup>2</sup>
<b>B</b> 	Approx. Weight HD <sup>2</sup> Smooth	3 779 lbs	1 714 kg
	Number of rows	11	
<b>C</b> 	Coverage per row	12.31 ft <sup>2</sup>	1.14 m <sup>2</sup>
	Lin. coverage per row	11.37 lin. ft	3.47 lin. m
		<sup>2</sup> New packaging HD <sup>2</sup> Smooth - Available after depletion of original packaging	

## MECHANICAL INSTALLATION<sup>2</sup>

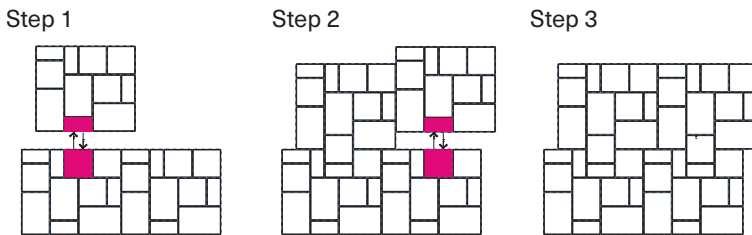

Clamp or Mechanical tool available for machine installation. Check with your local Techo-Bloc representative for more information.

## NOTES

See page 6 for icons description.

See page 26 for more information about applications.

See page 34 to 36 for more technical information. When used in a permeable pavement application, see page 100 to 110 for more technical information.

Please note that for barefoot walking areas (e.g. pool deck) dark-colored paving units could get very hot under the sun.

**JOINT WIDTH:** 5/32" (7 mm)  
**% OF SURFACE OPENING:** 4.5%\*  
**INFILTRATION RATE:** 570 in./hr (14 475 mm/hr)

\*For permeable application, the installation should be combined with Blu 6 x 13 in a modular pattern. A min. of 4.5% opening surface requires 75% of Blu 6 x 13 and 25% of Blu.

## Pallet Overview

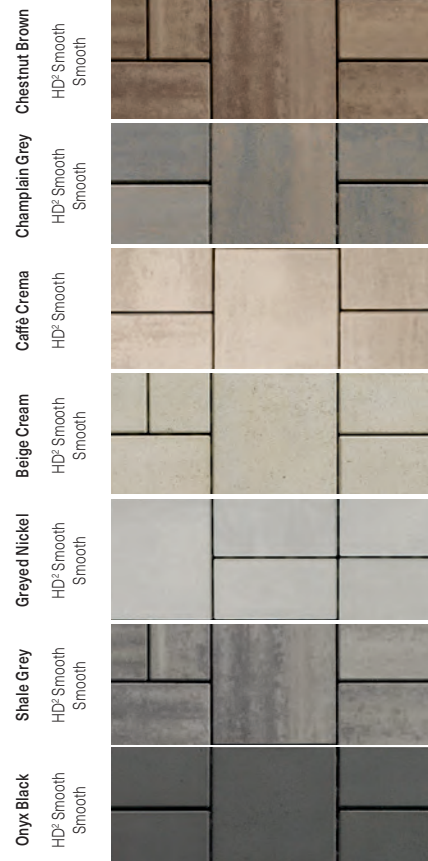
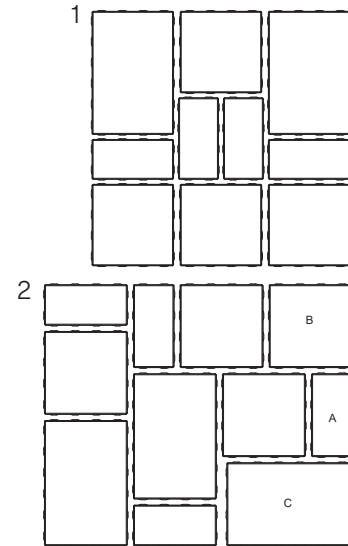





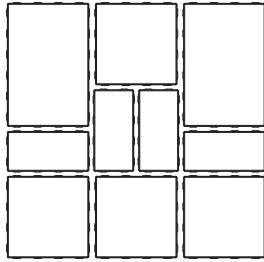

# BLU 60 mm

**DESCRIPTION:** Slab **TEXTURE:** Polished

## Pallet Overview



## Specifications per pallet

		Imperial	Metric
<b>A</b> 	Product dimension (L x W x H) <b>A</b>	6 1/2 x 13 x 2 3/16	165 x 330 x 55
	Product dimension (L x W x H) <b>B</b>	13 x 13 x 2 3/16	330 x 330 x 55
44 units / pallet	Product dimension (L x W x H) <b>C</b>	19 1/2 x 13 x 2 3/16	495 x 330 x 55
<b>B</b> 	Cubing	116.82 ft <sup>2</sup>	10.96 m <sup>2</sup>
	Approx. Weight	3 125 lbs	1 417 kg
44 units / pallet	Number of rows	11	
<b>C</b> 	Coverage per row	10.62 ft <sup>2</sup>	0.99 m <sup>2</sup>
	Lin. coverage per row	9.81 lin. ft	3.02 lin. m
22 units / pallet			



Polished  
Chestnut Brown



Polished  
Beige Cream



Polished  
Greyed Nickel



Polished  
Shale Grey



Polished  
Onyx Black

## Laying Patterns Options

01 | Modular

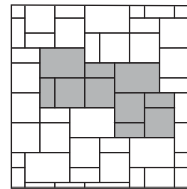

02 | Modular

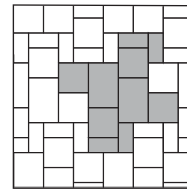

03 | Linear

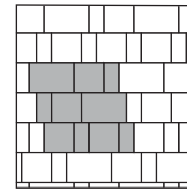

Patterns are for design inspiration only. The installer is responsible to calculate & purchase the correct amount of material.

## NOTES

See page 6 for icons description.

See page 26 for more information about applications.

See page 34 to 36 for more technical information. When used in a permeable pavement application, see page 100 to 110 for more technical information.

Please note that for barefoot walking areas (e.g. pool deck) dark-colored paving units could get very hot under the sun.

**JOINT WIDTH:** 3/32" (7 mm)

**% OF SURFACE OPENING:** 4.5%\*

**INFILTRATION RATE:** 570 in./hr (14 475 mm/hr)

**Polished is made-to-order, minimum order of 500 sq. ft. Deposit required.**

\*For permeable application, the installation should be combined with Blu 6 x 13 in a modular pattern. A min. of 4.5% opening surface requires 75% of Blu 6 x 13 and 25% of Blu.



# BLU 60 mm (6" x 13")

DESCRIPTION: Slab TEXTURE: Slate and HD<sup>2</sup> Slate



Specifications per pallet		Imperial	Metric
	Product dimension (L x W x H)	6 ½ x 13 x 2 ¾	165 x 330 x 60
	Cubing	116.05 ft <sup>2</sup>	10.78 m <sup>2</sup>
198 units / pallet	Approx. Weight Slate	3 138 lbs	1 423 kg
	Approx. Weight HD <sup>2</sup> Slate	3 183 lbs	1 444 kg
	Number of rows	11	
	Coverage per row	10.55 ft <sup>2</sup>	0.98 m <sup>2</sup>
Lin. coverage per row	Depth	19.5 lin. ft	5.94 lin. m
	Length	9.75 lin. ft	2.97 lin. m

## Pallet Overview

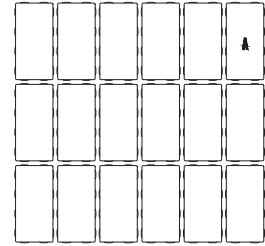

## Laying Patterns Options

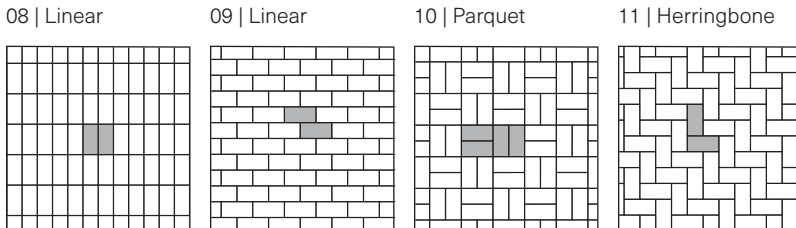

Patterns are for design inspiration only. The installer is responsible to calculate & purchase the correct amount of material.

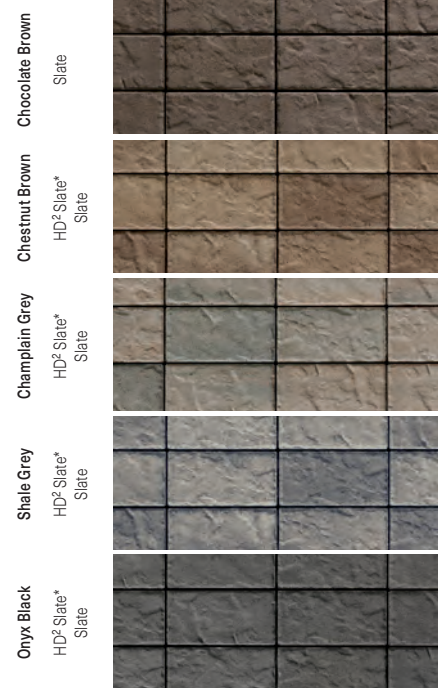

## NOTES

See page 6 for icons description.

See page 26 for more information about applications.

See page 34 to 36 for more technical information. When used in a permeable pavement application, see page 100 to 110 for more technical information.

**JOINT WIDTH:** 5/32" (7 mm)  
**% OF SURFACE OPENING:** 4.8%  
**INFILTRATION RATE:** 570 in./hr (14 475 mm/hr)

\*HD<sup>2</sup> Slate is only available in USA.

Please note that for barefoot walking areas (e.g. pool deck) dark-colored paving units could get very hot under the sun.



# BLU 60 mm (6" × 13")

**DESCRIPTION:** Slab **TEXTURE:** Smooth and HD² Smooth

## Pallet Overview

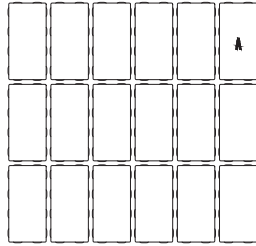

## Specifications per pallet



198 units / pallet

	Imperial	Metric
Product dimension (L × W × H)	6 ½ × 13 × 2 ¾	165 × 330 × 60
Cubing	116.05 ft²	10.78 m²
Approx. Weight Smooth	3 138 lbs	1 423 kg
Approx. Weight HD² Smooth	3 147 lbs	1 427 kg
Number of rows	11	
Coverage per row	10.55 ft²	0.98 m²
Lin. coverage per row	Depth 19.5 lin. ft	5.94 lin. m
	Length 9.75 lin. ft	2.97 lin. m



Smooth Chocolate Brown  
 HD² Smooth Smooth Chestnut Brown  
 HD² Smooth Smooth Champlain Grey  
 HD² Smooth Smooth Caffè Crema  
 HD² Smooth Smooth Beige Cream  
 HD² Smooth Smooth Greyed Nickel  
 HD² Smooth Smooth Shale Grey  
 HD² Smooth Smooth Onyx Black

## Laying Patterns Options

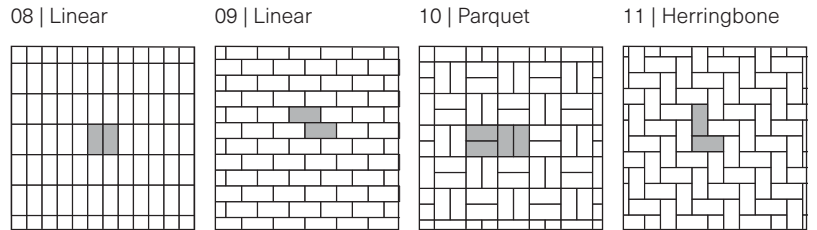

Patterns are for design inspiration only. The installer is responsible to calculate & purchase the correct amount of material.

## NOTES

See page 6 for icons description.  
 See page 26 for more information about applications.  
 See page 34 to 36 for more technical information. When used in a permeable pavement application, see page 100 to 110 for more technical information.

**JOINT WIDTH:** ½" (7 mm)  
**% OF SURFACE OPENING:** 4.8%  
**INFILTRATION RATE:** 570 in./hr (14 475 mm/hr)

Please note that for barefoot walking areas (e.g. pool deck) dark-colored paving units could get very hot under the sun.



# BLU GRANDE

DESCRIPTION: Slab TEXTURE: Slate and HD² Slate

SLATE		Imperial	Metric
<b>Specifications per pallet</b>			
	Product dimension (L x W x H)	32 ½ x 19 ½ x 2 ¾	825 x 495 x 60
	Cubing	87.91 ft²	8.17 m²
20 units / pallet	Approx. Weight	2 434 lbs	1 104 kg
	Number of rows	10	
	Coverage per row	8.79 ft²	0.82 m²
Lin. coverage per row	Depth	3.25 lin. ft	0.99 lin. m
	Length	5.41 lin. ft	1.65 lin. m

HD² SLATE		Imperial	Metric
<b>Specifications per pallet</b>			
	Product dimension (L x W x H)	32 ½ x 19 ½ x 2 ¾	825 x 495 x 60
	Cubing	96.71 ft²	8.98 m²
22 units / pallet	Approx. Weight	2 689 lbs	1 220 kg
	Number of rows	11	
	Coverage per row	8.79 ft²	0.82 m²
Lin. coverage per row	Depth	3.25 lin. ft	0.99 lin. m
	Length	5.41 lin. ft	1.65 lin. m

## Pallet Overview

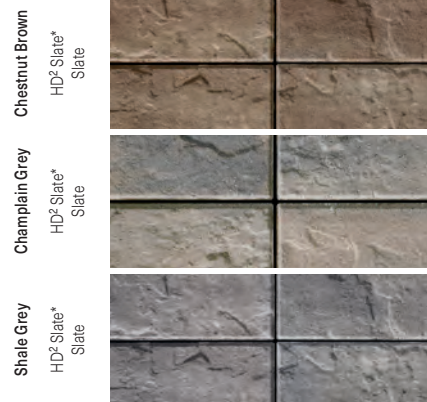
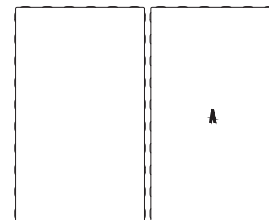

## Laying Patterns Options

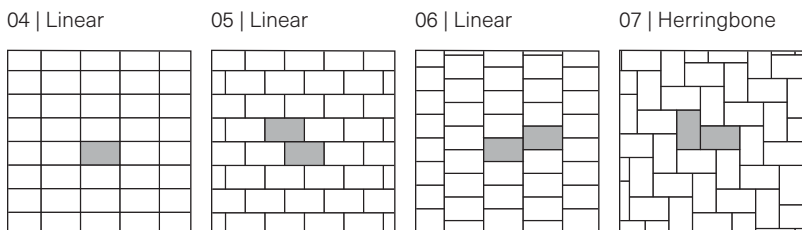

Patterns are for design inspiration only. The installer is responsible to calculate & purchase the correct amount of material.

## NOTES

See page 6 for icons description.

See page 26 for more information about applications.

See page 34 to 36 for more technical information.

Allowable load Capacity of slab on pedestal set (including a safety factor of 2): 776 lb (352 kg)

The application on pedestal Set for Blu Grande is recommended for Blu Grande in HD² only.

\*HD² Slate is only available in USA.

Please note that for barefoot walking areas (e.g. pool deck) dark-colored paving units could get very hot under the sun.



# BLU GRANDE

DESCRIPTION: Slab TEXTURE: Smooth and HD² Smooth

## Pallet Overview

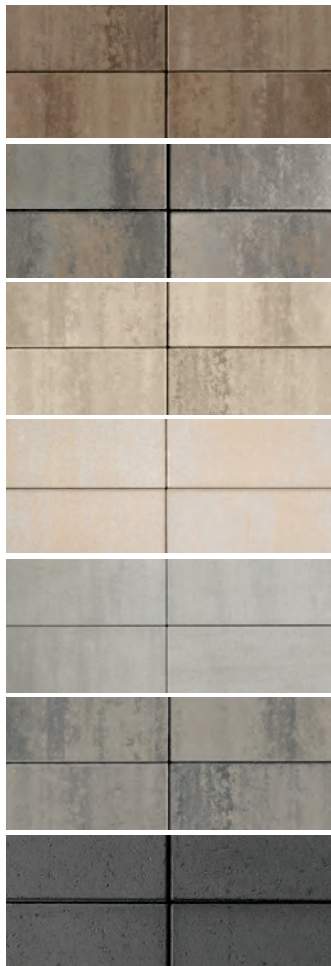
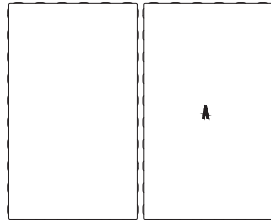

HD² Smooth Smooth Chestnut Brown  
 HD² Smooth Smooth Champlain Grey  
 HD² Smooth Smooth Caffè Crema  
 HD² Smooth Smooth Beige Cream  
 HD² Smooth Smooth Greyed Nickel  
 HD² Smooth Smooth Shale Grey  
 Smooth Onyx Black

## SMOOTH

### Specifications per pallet

	Imperial	Metric
 Product dimension (L x W x H)	32 ½ x 19 ½ x 2 ¾	825 x 495 x 60
Cubing	87.91 ft²	8.17 m²
20 units / pallet	Approx. Weight	2 382 lbs / 1 081 kg
	Number of rows	10
	Coverage per row	8.79 ft² / 0.82 m²
Lin. coverage per row	Depth	3.25 lin. ft / 0.99 lin. m
	Length	5.41 lin. ft / 1.65 lin. m

## HD² SMOOTH

### Specifications per pallet

	Imperial	Metric
 Product dimension (L x W x H)	32 ½ x 19 ½ x 2 ¾	825 x 495 x 60
Cubing	96.71 ft²	8.98 m²
22 units / pallet	Approx. Weight	2 744 lbs / 1 244 kg
	Number of rows	11
	Coverage per row	8.79 ft² / 0.82 m²
Lin. coverage per row	Depth	3.25 lin. ft / 0.99 lin. m
	Length	5.41 lin. ft / 1.65 lin. m

## Laying Patterns Options

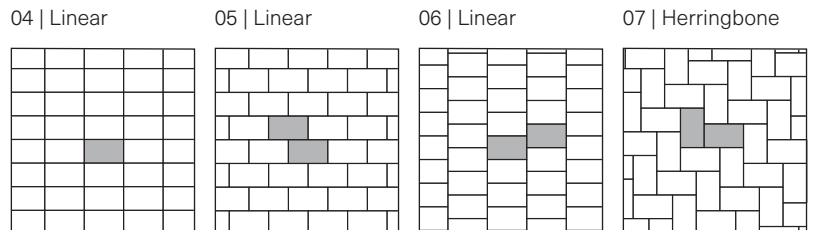

Patterns are for design inspiration only. The installer is responsible to calculate & purchase the correct amount of material.

## NOTES

See page 6 for icons description.  
 See page 26 for more information about applications.  
 See page 34 to 36 for more technical information.  
 Allowable load Capacity of slab on pedestal set (including a safety factor of 2): 776 lb (352 kg)

The application on pedestal Set for Blu Grande is recommended for Blu Grande in HD² only.  
 Please note that for barefoot walking areas (e.g. pool deck) dark-colored paving units could get very hot under the sun.



# BLU GRANDE

DESCRIPTION: Slab TEXTURE: Polished



POLISHED		Imperial	Metric
<b>Specifications per pallet</b>			
	Product dimension (L x W x H)	32 1/2 x 19 1/2 x 2 3/16	825 x 495 x 55
	Cubing	87.91 ft <sup>2</sup>	8.17 m <sup>2</sup>
20 units / pallet	Approx. Weight	2 525 lbs	1 145 kg
	Number of rows	10	
	Coverage per row	8.79 ft <sup>2</sup>	0.82 m <sup>2</sup>
Lin. coverage per row	Depth	3.25 lin. ft	0.99 lin. m
	Length	5.41 lin. ft	1.65 lin. m

## Pallet Overview

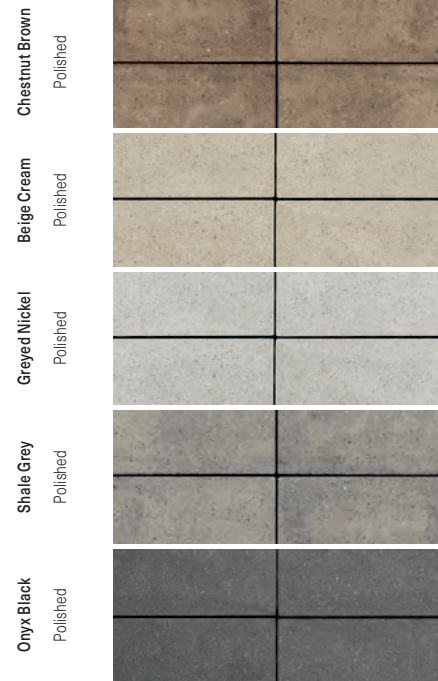
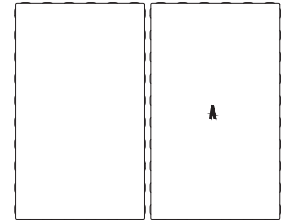

## Laying Patterns Options

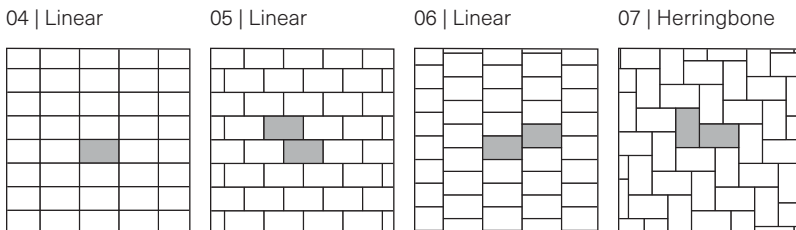

Patterns are for design inspiration only. The installer is responsible to calculate & purchase the correct amount of material.

## NOTES

See page 6 for icons description.  
 See page 26 for more information about applications.  
 See page 34 to 36 for more technical information.

**Polished is made-to-order, minimum order of 500 sq. ft. Deposit required.**

Please note that for barefoot walking areas (e.g. pool deck) dark-colored paving units could get very hot under the sun.



# BOREALIS

DESCRIPTION: Slab TEXTURE: Klean-Bloc Wood

## Pallet Overview - 5 x 30

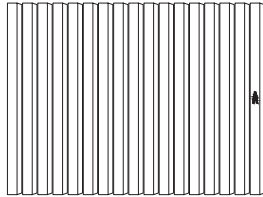

## Pallet Overview - 10 x 30

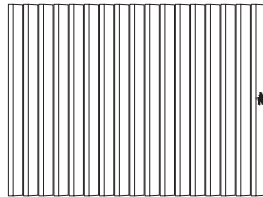

Klean-Bloc Wood  
Smoked Pine  
Klean-Bloc Wood  
Hazelnut Brandy  
Klean-Bloc Wood  
Riviera

### 5" x 30"

#### Specifications per pallet



68 units / pallet

		Imperial	Metric
Product dimension (L x W x H)		30 x 5 x 2 1/4	762 x 127 x 57
Cubing		70.83 ft <sup>2</sup>	6.58 m <sup>2</sup>
Units		1.04 ft <sup>2</sup>	0.10 m <sup>2</sup>
Approx. Weight		1 784 lbs	809 kg
Number of rows		4	
Coverage per row		17.71 ft <sup>2</sup>	1.65 m <sup>2</sup>
Lin. coverage per row	Depth	7.08 lin. ft	2.16 lin. m
	Length	42.5 lin. ft	12.96 lin. m

### 10" x 30"

#### Specifications per pallet



34 units / pallet

		Imperial	Metric
Product dimension (L x W x H)		30 x 10 x 2 1/4	762 x 254 x 57
Cubing		70.83 ft <sup>2</sup>	6.58 m <sup>2</sup>
Approx. Weight		1 881 lbs	853 kg
Number of rows		2	
Coverage per row		35.42 ft <sup>2</sup>	3.29 m <sup>2</sup>
Lin. coverage per row	Depth	42.5 lin. ft	12.95 lin. m
	Length	14.2 lin. ft	4.33 lin. m

## Laying Patterns Options

01 | Linear

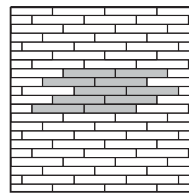

02 | Linear

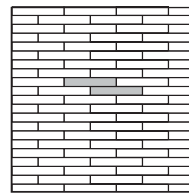

03 | Linear

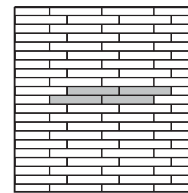

04 | Linear

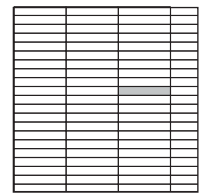

05 | Herringbone

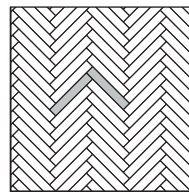

06 | Linear

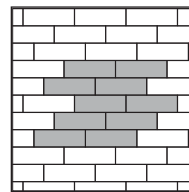

## NOTES

Palletized upright.

See page 6 for icons description.

See page 26 for more information about applications.

See page 34 to 36 for more technical information.

\*For an authentic look, each color option is composed of a variety of darker & lighter tones. Natural ingredients

such as granite are present within the recipe to allow for a range in tones, veining and textures from one stone to another.

In order to obtain a more realistic appearance to natural stone, wet cast (Stonedge collection) slabs are intended to have a slightly larger variance in their dimensions than dry cast slabs. See Notes for dimensional tolerances on page 34.

**IMPORTANT:** When installing Borealis 5 x 30 or Borealis 10 x 30, it is recommended to have a gap between 1/16 and 3/16 in. (2 and 5 mm), between the units, to allow the sand to enter between each unit.

Please note that for barefoot walking areas (e.g. pool deck) dark-colored paving units could get very hot under the sun.

Patterns are for design inspiration only. The installer is responsible to calculate & purchase the correct amount of material.



# BOREALIS Stepping Stones

DESCRIPTION: Slab TEXTURE: Wood

Specifications per pallet	Imperial	Metric
 Product dimension (L x W x H)	24 x 24 x 2 ¼	610 x 610 x 57
Cubing	64 ft <sup>2</sup>	5.95 m <sup>2</sup> / pal
Approx. Weight	1 257 lbs	570 kg
Number of rows	8	
Coverage per unit	4 ft <sup>2</sup>	0.37 m <sup>2</sup>

16 units / pallet

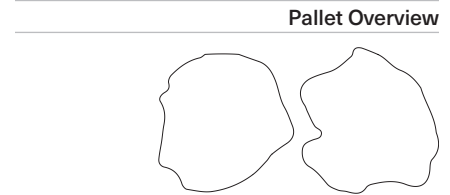

Hazelnut Brandy  
Wood

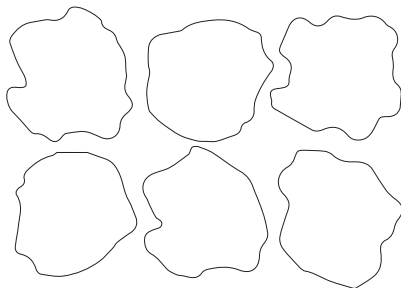
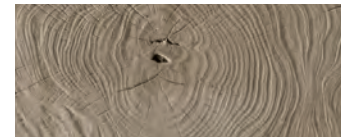

6 different shapes available

## NOTES

See page 6 for icons description.  
See page 26 for more information about applications.  
See page 34 to 36 for more technical information.

In order to obtain a more realistic appearance to natural stone, wet cast (Stonedge collection) slabs are intended to have a slightly larger variance in their dimensions than dry cast slabs. See Notes for dimensional tolerances on page 34.

Please note that for barefoot walking areas (e.g. pool deck) dark-colored paving units could get very hot under the sun.



250x250



250x250 250x250

# EVEREST Square

DESCRIPTION: Slab TEXTURE: HD² Slate

## Pallet Overview - 250 × 250

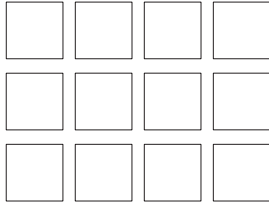

## Specifications per pallet



132 units / pallet

	Imperial	Metric
Product dimension (L × W × H)	9 13/16 × 9 13/16 × 2 3/8	250 × 250 × 60
Cubing	88.80 ft²	8.25 m²
Approx. Weight	2 547 lbs	1 155 kg
Number of rows	11	
Coverage per row	8.07 ft²	0.75 m²

## Pallet Overview - 500 × 500

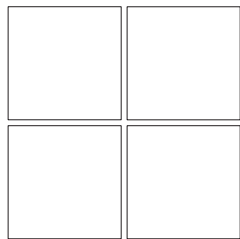

## Specifications per pallet



44 units / pallet

	Imperial	Metric
Product dimension (L × W × H)	19 11/16 × 19 11/16 × 2 3/8	500 × 500 × 60
Cubing	118.40 ft²	11 m²
Approx. Weight	3 383 lbs	1 535 kg
Number of rows	11	
Coverage per row	10.76 ft²	1 m²



HD² Slate Chestnut Brown  
 HD² Slate Caffè Crema  
 HD² Slate Greyed Nickel  
 HD² Slate Shale Grey

## Laying Patterns Options

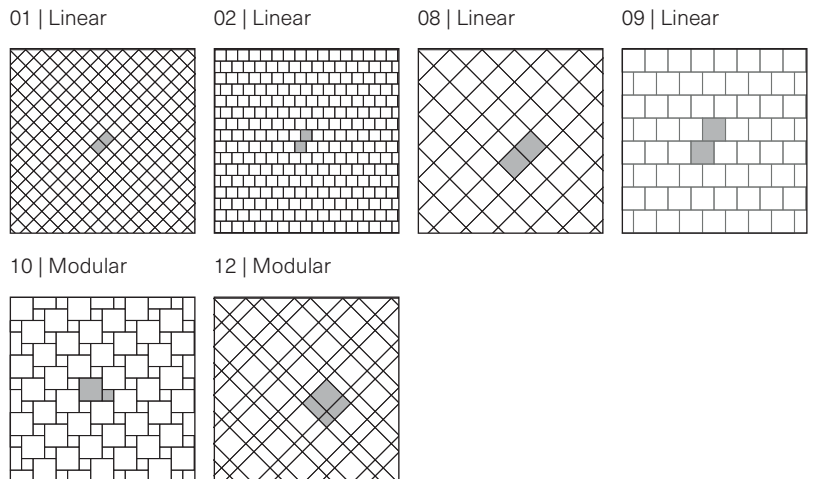

Patterns are for design inspiration only. The installer is responsible to calculate & purchase the correct amount of material.

## NOTES

**Pedestal Set Application:**  
 Everest 500 × 500 can be used with pedestals at each corner (pedestrian use only). Allowable load Capacity of slab on pedestal set (including a safety factor of 2): 1 300 lb (590 kg)

See page 6 for icons description.

See page 26 for more information about applications.

See page 34 to 36 for more technical information.

Please note that for barefoot walking areas (e.g. pool deck) dark-colored paving units could get very hot under the sun.

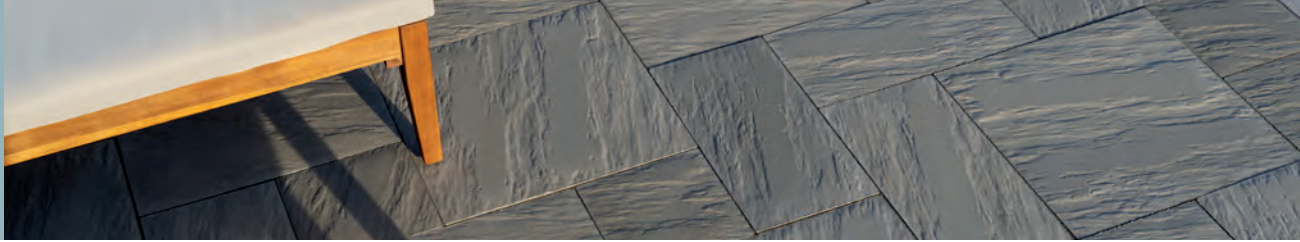

# EVEREST Rectangle

DESCRIPTION: Slab TEXTURE: HD² Slate

Specifications per pallet	Imperial	Metric
 Product dimension (L x W x H)	19 1/16 x 9 13/16 x 2 3/8	500 x 250 x 60
Cubing	88.80 ft³	8.25 m³
Approx. Weight	2 547 lbs	1 155 kg
Number of rows	11	
Coverage per row	8.07 ft²	0.75 m²

### Pallet Overview - 250 x 500

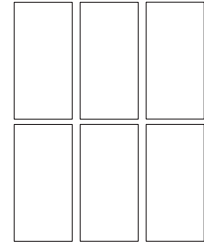

### Laying Patterns Options

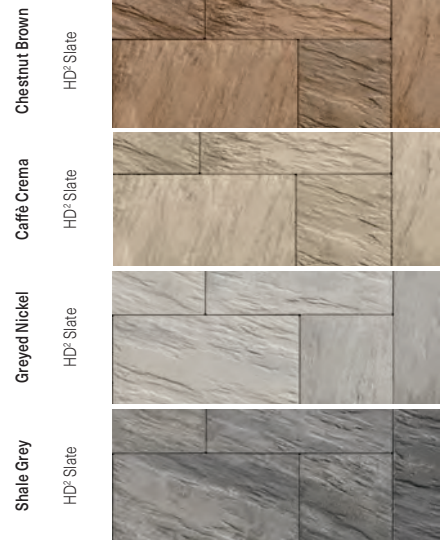
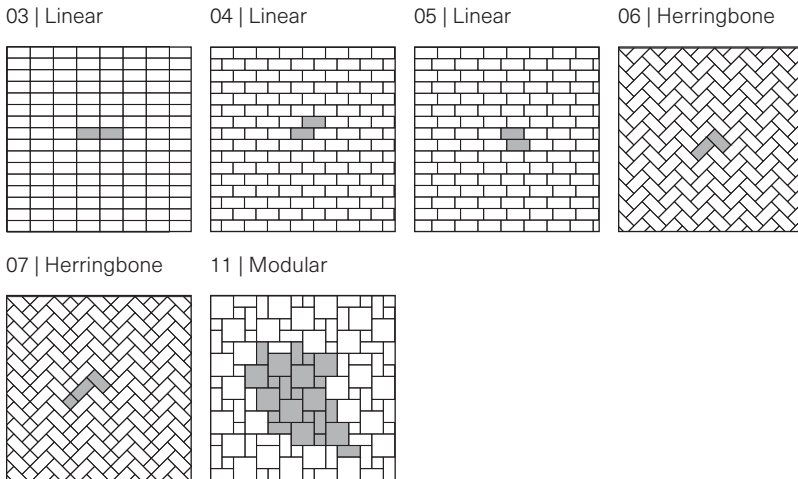

Patterns are for design inspiration only. The installer is responsible to calculate & purchase the correct amount of material.

### NOTES

See page 6 for icons description.  
 See page 26 for more information about applications.  
 See page 34 to 36 for more technical information.

Please note that for barefoot walking areas (e.g. pool deck) dark-colored paving units could get very hot under the sun.



# HEXA 60 mm

DESCRIPTION: Slab TEXTURE: HD² Smooth

## Pallet Overview

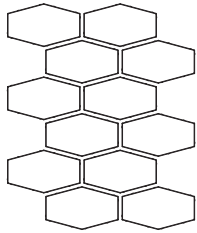

## Specifications per pallet

	Imperial	Metric
 Product dimension (L x W x H)	15 3/16" x 9" x 2 3/8"	385 x 228 x 60
Cubing	96.55 ft²	8.97 m²
132 units / pallet	Approx. Weight	2 824 lbs / 1 281 kg
	Number of rows	11
	Coverage per row	8.78 ft² / 0.82 m²



HD² Smooth Chestnut Brown  
 HD² Smooth Caffè Crema  
 HD² Smooth Beige Cream  
 HD² Smooth Greyed Nickel  
 HD² Smooth Shale Grey  
 HD² Smooth Onyx Black

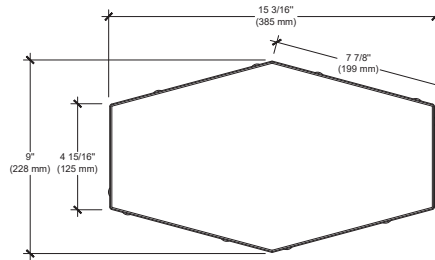

## Laying Patterns Options

01 | Hexagon

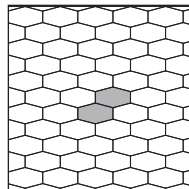

Patterns are for design inspiration only. The installer is responsible to calculate & purchase the correct amount of material.

## NOTES

See page 6 for icons description.  
 See page 26 for more information about applications.  
 See page 34 to 36 for more technical information.

Please note that for barefoot walking areas (e.g. pool deck) dark-colored paving units could get very hot under the sun.





# INDUSTRIA Slab

**DESCRIPTION:** Slab **Texture:** HD<sup>2</sup> Smooth, HD<sup>2</sup> Granitex or HD<sup>2</sup> Polished



HD <sup>2</sup> SMOOTH AND HD <sup>2</sup> GRANITEX			
600 × 600		Imperial	Metric
 22 units / pallet	Product dimension (L × W × H)	23 5/8 × 23 5/8 × 2 3/8	600 × 600 × 60
	Cubing	85.25 ft <sup>2</sup>	7.92 m <sup>2</sup>
	Approx. Weight	2 432 lbs	1 103 kg
	Number of rows	11	
	Coverage per row	7.75 ft <sup>2</sup>	0.72 m <sup>2</sup>
Lin. coverage per row		3.94 lin. ft	1.20 lin. m

900 × 600			
900 × 600		Imperial	Metric
 22 units / pallet	Product dimension (L × W × H)	35 7/8 × 23 5/8 × 2 3/8	900 × 600 × 60
	Cubing	127.88 ft <sup>2</sup>	11.88 m <sup>2</sup>
	Approx. Weight	3 622 lbs	1 643 kg
	Number of rows	11	
	Coverage per row	11.63 ft <sup>2</sup>	1.08 m <sup>2</sup>
Lin. coverage per row	Depth	3.94 lin. ft	1.20 lin. m
	Length	5.91 lin. ft	1.80 lin. m

HD <sup>2</sup> POLISHED			
600 × 600		Imperial	Metric
 22 units / pallet	Product dimension (L × W × H)	23 5/8 × 23 5/8 × 2 3/8	600 × 600 × 55
	Cubing	85.25 ft <sup>2</sup>	7.92 m <sup>2</sup>
	Approx. Weight	2 432 lbs	1 103 kg
	Number of rows	11	
	Coverage per row	7.75 ft <sup>2</sup>	0.72 m <sup>2</sup>
Lin. coverage per row		3.94 lin. ft	1.20 lin. m

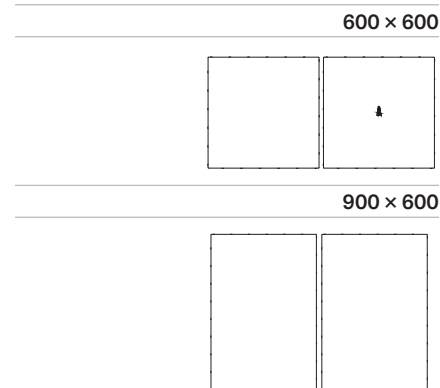

## NOTES

See page 6 for icons description.

See page 26 for more information about applications.

See page 34 to 36 for more technical information.

Allowable load Capacity of slab on pedestal set (including a safety factor of 2): 1441 lb (653 kg)

Please note that for barefoot walking areas (e.g. pool deck) dark-colored paving units could get very hot under the sun.

**HD<sup>2</sup> Polished and HD<sup>2</sup> Granitex is made-to-order, minimum order of 500 sq. ft. Deposit required.**

**See page 22 for list of In-Stock or On order colors for all items of Industria Collection.**

**EXPANDING DESIGN HORIZONS WITH LIVEABLE ROOFTOPS.**

### COOL ROOF

High Solar Reflectivity

### LENGTHENS ROOF LIFE SPAN

Protects the waterproofing membrane from UV rays and accidental perforations.

### EASY ACCESS FOR MAINTENANCE

When installed on pedestals, INDUSTRIA slab can be moved for roof system maintenance.



# FLORA Slab

DESCRIPTION: Slab TEXTURE: HD² Smooth

## Pallet Overview



## HD² SMOOTH

Specifications per pallet	Imperial	Metric
Product dimension (L x W x H)	23 5/8 x 23 5/8 x 2 3/8	600 x 600 x 60
Cubing	85.25 ft²	7.92 m²
Approx. Weight	2 432 lbs	1 103 kg
Number of rows	11	
Coverage per row	7.75 ft²	0.72 m²
Lin. coverage per row	3.94 lin. ft	1.20 lin. m



22 units / pallet



## Patterns

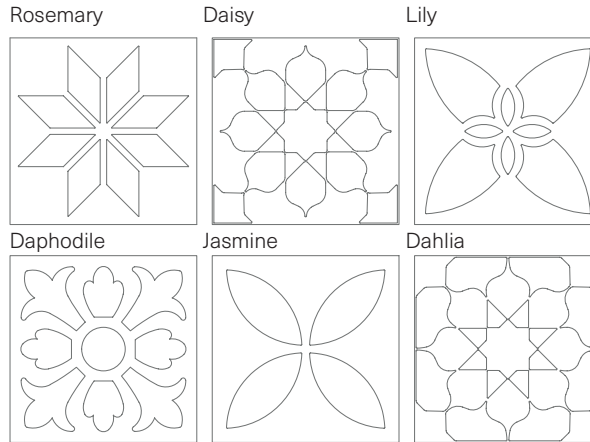

## Laying Patterns Options

01 | All 6 Flora      02 | 75% 600 x 600 / 25% Flora

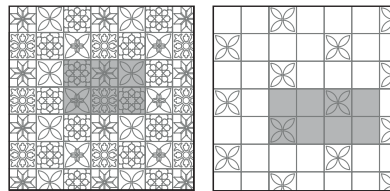

Patterns are for design inspiration only. The installer is responsible to calculate & purchase the correct amount of material.

### EXPANDING DESIGN HORIZONS WITH LIVEABLE ROOFTOPS.

**COOL ROOF**  
High Solar Reflectivity

**LENGTHENS ROOF LIFE SPAN**  
Protects the waterproofing membrane from UV rays and accidental perforations.

**EASY ACCESS FOR MAINTENANCE**  
When installed on pedestals, INDUSTRIA slab can be moved for roof system maintenance.

## NOTES

See page 6 for icons description.

See page 26 for more information about applications.

See page 34 to 36 for more technical information.

Allowable load Capacity of slab on pedestal set (including a safety factor of 2): 1441 lb (653 kg)

Please note that for barefoot walking areas (e.g. pool deck) dark-colored paving units could get very hot under the sun.



# MAYA

DESCRIPTION: Slab Texture: Slate



Specifications per pallet	Imperial	Metric
 Product dimension (L x W x H)	31 x 23 x 2 ¼	788 x 584 x 57
Cubing	17 units	17 units
17 units / pallet	Approx. Weight per pallet	1 695 lbs / 769 kg
	Approx. Weight by unit	89 lbs / 41 kg
	Number of rows	1
	Coverage per unit	4.95 ft <sup>2</sup> / 0.46 m <sup>2</sup>
	Coverage per pallet	84.15 ft <sup>2</sup> / 7.82 m <sup>2</sup>

## Pallet Overview

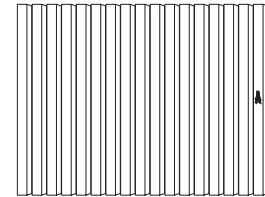

Natural stone

Victoria



Natural stone

Riviera

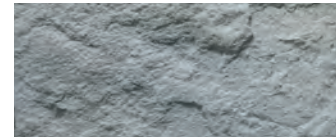

## NOTES

Palletized upright.

It is preferable to lay the stones in a random configuration.

Each pallet contains a variation of four different shapes.

\*For an authentic look, each color option is composed of a variety of darker & lighter tones. Natural ingredients such as granite are present within the recipe to allow for a range in tones, veining and textures from one stone to another.

In order to obtain a more realistic appearance to natural stone, wet cast (Stonedge collection) slabs

are intended to have a slightly larger variance in their dimensions than dry cast slabs. See Notes for dimensional tolerances on page 34.

See page 6 for icons description.

See page 26 for more information about applications.

See page 34 to 36 for more technical information.

Please note that for barefoot walking areas (e.g. pool deck) dark-colored paving units could get very hot under the sun.



# PARA 500 × 250 & 500 × 500

DESCRIPTION: Slab TEXTURE: HD² Smooth

## Pallet Overview - 500 × 250

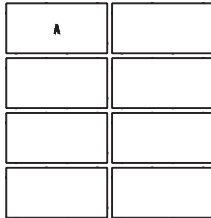

## Pallet Overview - 500 × 500

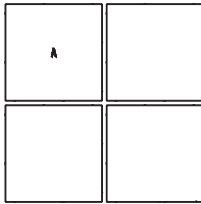

### Specifications per pallet



88 units / pallet

	Imperial	Metric
Product dimension (L × W × H)	9 1/16 × 19 1/16 × 2 3/8	250 × 500 × 60
Cubing	118.40 ft²	11 m²
Approx. Weight	3 422 lbs	1 552 kg
Number of rows	11	
Coverage per row	10.76 ft²	1 m²
Lin. coverage per row	Depth: 6.56 lin. ft Length: 13.12 lin. ft	2 lin. m 4 lin. m

### Specifications per pallet



44 units / pallet

	Imperial	Metric
Product dimension (L × W × H)	19 1/16 × 19 1/16 × 2 3/8	500 × 500 × 60
Cubing	118.40 ft²	11 m²
Approx. Weight	3 403 lb	1 544 kg
Number of rows	11	
Coverage per row	10.76 ft²	1 m²
Linear coverage per row	6.56 lin. ft	2 lin. m

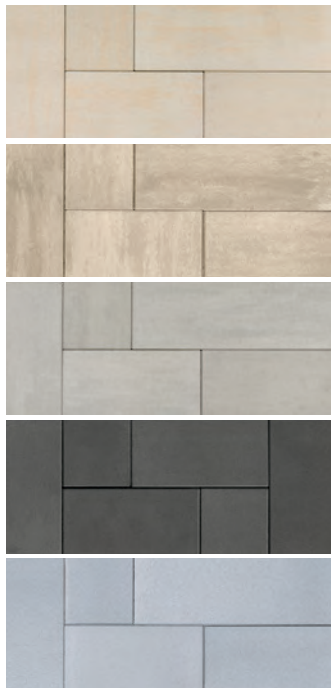

HD² Smooth Beige Cream  
HD² Smooth Caffè Crema  
HD² Smooth Greyed Nickel  
HD² Smooth Onyx Black  
HD² Smooth Silver Granite

### Laying Patterns Options

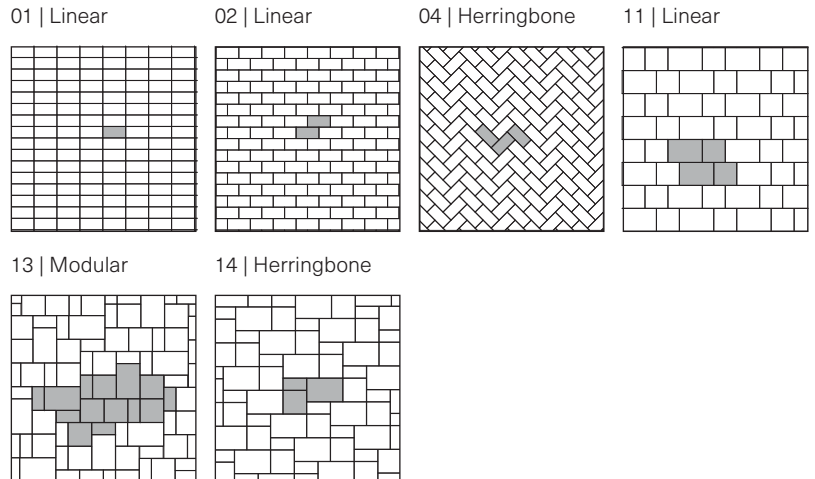

Patterns are for design inspiration only. The installer is responsible to calculate & purchase the correct amount of material.

### NOTES

**Pedestal Set Application:**  
Para 500 × 500 can be used with pedestals at each corner (pedestrian use only). Allowable load Capacity of slab on pedestal set (including a safety factor of 2): 1 300 lb (590 kg)

Please note that for barefoot walking areas (e.g. pool deck) dark-colored paving units could get very hot under the sun.

See page 6 for icons description.  
See page 26 for more information about applications.  
See page 34 to 36 for more technical information.



# PARA 500 × 750

DESCRIPTION: Slab TEXTURE: HD<sup>2</sup> Smooth



Specifications per pallet		Imperial	Metric	
	Product dimension (L×W×H)	29 ½ × 19 ⅞ × 2 ¾	750 × 500 × 60	
	Cubing	88.80 ft <sup>2</sup>	8.25 m <sup>2</sup>	
22 units / pallet	Approx. Weight	2 537 lbs	1 151 kg	
	Number of rows	11		
	Coverage per row	8.07 ft <sup>2</sup>	0.75 m <sup>2</sup>	
	Lin. coverage per row	Depth	3.28 lin. ft	1 lin. m
		Length	4.92 lin. ft	1.50 lin. m

## Pallet Overview - 750 × 500

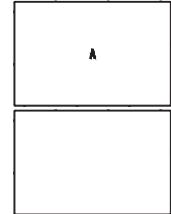

## Laying Patterns Options

06 | Linear

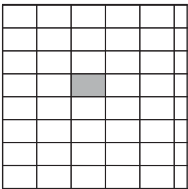

07 | Linear

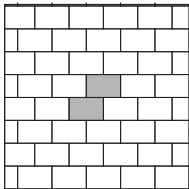

08 | Linear

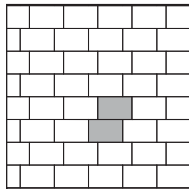

09 | Herringbone

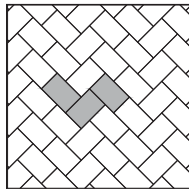

10 | Linear

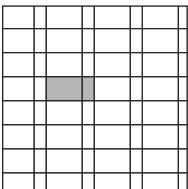

Patterns are for design inspiration only. The installer is responsible to calculate & purchase the correct amount of material.

## NOTES

See page 6 for icons description.  
 See page 26 for more information about applications.  
 See page 34 to 36 for more technical information.

Allowable load Capacity of slab on pedestal set (including a safety factor of 2): 1135 lb (514 kg)  
 Please note that for barefoot walking areas (e.g. pool deck) dark-colored paving units could get very hot under the sun.

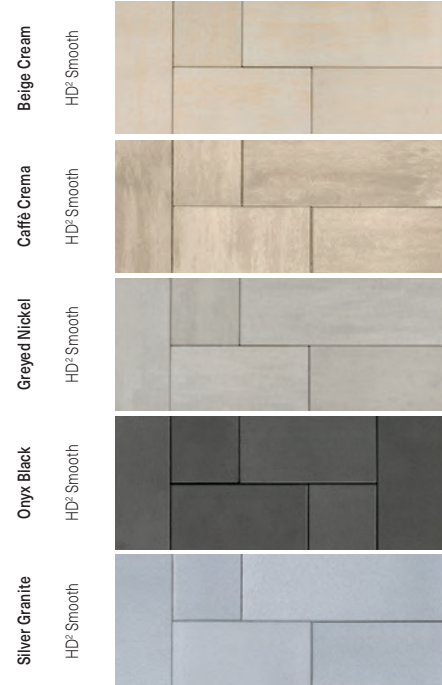



# SANDSTONE

DESCRIPTION: Slab TEXTURE: Natural Stone

## Pallet Overview - 3-Piece Pattern Cut

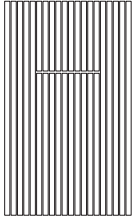

## Pallet Overview - Large Format

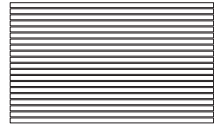

## Pallet Overview - Accent Slab

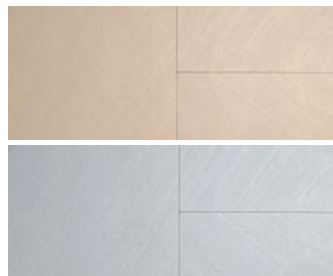
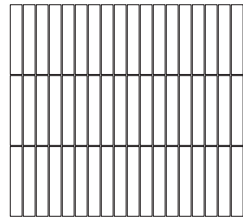

Natural Stone Beige  
Natural Stone Grey

## 3-Piece Pattern Cut

Specifications per pallet		Imperial	Metric
<b>A</b>	Product dimension (L x W x H) <b>A</b>	11 5/8 x 23 5/8 x 7/8	295 x 600 x 22
	Product dimension (L x W x H) <b>B</b>	23 5/8 x 23 5/8 x 7/8	600 x 600 x 22
	Product dimension (L x W x H) <b>C</b>	35 5/8 x 23 5/8 x 7/8	905 x 600 x 22
10 units / pallet	Cubing*	120 ft <sup>2</sup>	11.15 m <sup>2</sup>
10 units / pallet	Approx. Weight	1 433 lbs	650 kg
<b>C</b>	Number of rows	1	
	Coverage per row*	120 ft <sup>2</sup>	11.15 m <sup>2</sup>
10 units / pallet	Lin. coverage per row*	60.04 lin. ft	18.30 lin. m

## Large Format

Specifications per pallet		Imperial	Metric
	Product dimension (L x W x H)	35 5/8 x 23 5/8 x 7/8	905 x 600 x 22
	Cubing*	120 ft <sup>2</sup>	11.16 m <sup>2</sup>
20 units / pallet	Approx. Weight	1 512 lbs	686 kg
	Number of rows	1	
	Coverage per row*	120 ft <sup>2</sup>	11.16 m <sup>2</sup>
	Lin. coverage per row*	60 lin. ft	18.30 lin. m

## Accent Slab

Specifications per pallet		Imperial	Metric
	Product dimension (L x W x H)	11 5/8 x 3 1/8 x 1 15/16	295 x 80 x 50
	Cubing*	95.73 ft <sup>2</sup>	8.89 m <sup>2</sup>
324 units / pallet	Approx. Weight	2213 lbs	1 004 kg
	Number of rows	6	
	Coverage per row*	15.96 ft <sup>2</sup>	1.48 m <sup>2</sup>
	Lin. coverage per row*	Width 15.94 lin. ft Length 54.04 lin. ft	4.86 lin. m 16.47 lin. m

## NOTES

See page 6 for icons description.  
See page 26 for more information about applications.  
See page 34 to 36 for more technical information.

\*Including 3/8 in (10 mm) joint width

### NATURAL STONE COLLECTION

Natural stones are products of nature. They are sold as is and are not covered by Techo-Bloc's Warranty. Installation is deemed acceptance of products.

Please note that for barefoot walking areas (e.g. pool deck) dark-colored paving units could get very hot under the sun.

## Laying Patterns Options

01 | Modular 3-Piece

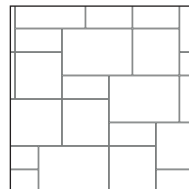

02 | Linear 3-Piece

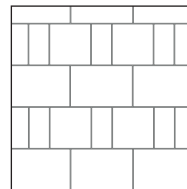

03 | Linear Large Format

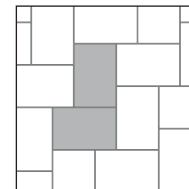

04 | Herringbone Accent slab

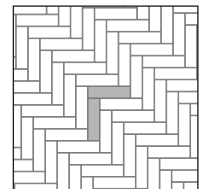

Patterns are for design inspiration only. The installer is responsible to calculate & purchase the correct amount of material.



# TERRAZZO

DESCRIPTION: Slab TEXTURE: Polished



## 600 x 150

### Specifications per pallet



108 units / pallet

		Imperial	Metric
Product dimension (L x W x H)		23 5/8 x 5 7/8 x 2 3/8	600 x 150 x 60
Cubing		104.63 ft <sup>3</sup>	9.72 m <sup>3</sup>
Approx. Weight		3 050 lbs	1 383 kg
Number of rows		9	
Coverage per row		11.63 ft <sup>2</sup>	1.08 m <sup>2</sup>
Lin. coverage per row	Width	5.91 lin. ft	1.80 lin. m
	Length	23.62 lin. ft	7.20 lin. m

## 600 x 300

### Specifications per pallet



54 units / pallet

		Imperial	Metric
Product dimension (L x W x H)		23 5/8 x 11 13/16 x 2 3/8	600 x 300 x 60
Cubing		104.63 ft <sup>3</sup>	9.72 m <sup>3</sup>
Approx. Weight		2 969 lbs	1 347 kg
Number of rows		9	
Coverage per row		11.63 ft <sup>2</sup>	1.08 m <sup>2</sup>
Lin. coverage per row	Width	5.91 lin. ft	1.80 lin. m
	Length	11.81 lin. ft	3.60 lin. m

### Pallet Overview - 600 x 150

### Pallet Overview - 600 x 300

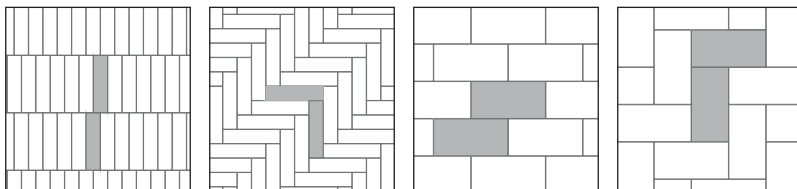

## Laying Patterns Options

02 | Running Bond    04 | Herringbone    07 | Running Bond    08 | Herringbone

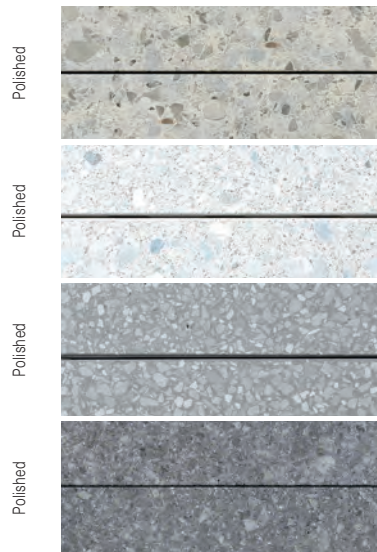

Patterns are for design inspiration only. The installer is responsible to calculate & purchase the correct amount of material.

Stardust Beige  
Mineral White  
Moonrock Grey  
Meteor Black



## NOTES

See page 6 for icons description.  
See page 26 for more information about applications.  
See page 34 to 36 for more technical information.  
Every unit is calibrated to ensure height is within a 1 mm tolerance.

\*The Terrazzo Collection comes with a factory-applied, water-based "natural look" protectant that enhances the surface and aids in maintenance. However, to maintain its de-icing salt resistant properties, it is essential to re-apply a concrete or natural stone water-based protectant or sealer periodically.

We recommend applying the protectant as soon as you observe water absorption. If water is still repelled, re-application is not yet necessary. Always test the protectant or sealer on a small, hidden area before full application.

Please note that for barefoot walking areas (e.g. pool deck) dark-colored paving units could get very hot under the sun.



# TERRAZZO

**DESCRIPTION:** Slab **TEXTURE:** Polished

## Pallet Overview - 600 × 600



## 600 × 600

Specifications per pallet	Imperial	Metric
Product dimension (L × W × H)	23 5/8 × 23 5/8 × 2 3/8	600 × 600 × 60
Cubing	69.75 ft <sup>2</sup>	6.48 m <sup>2</sup>
Approx. Weight	2 060 lbs	934 kg
Number of rows	9	
Coverage per row	7.75 ft <sup>2</sup>	0.72 m <sup>2</sup>
Lin. coverage per row	3.94 lin. ft	1.20 lin. m



18 units / pallet

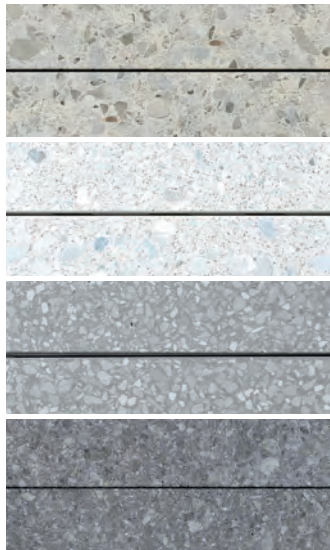

Polished **Stardust Beige**  
 Polished **Mineral White**  
 Polished **Moonrock Grey**  
 Polished **Meteor Black**

## Laying Patterns Options

09 | Stack Bond

12 | Linear

13 | Linear

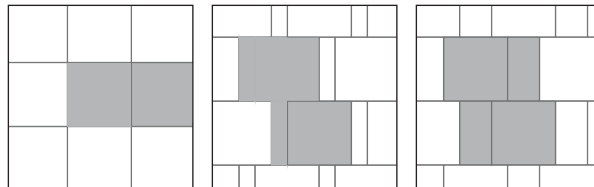

Patterns are for design inspiration only. The installer is responsible to calculate & purchase the correct amount of material.

## NOTES

See page 6 for icons description.

See page 26 for more information about applications.

See page 34 to 36 for more technical information.

Every unit is calibrated to ensure height is within a 1 mm tolerance.

\*The Terrazzo Collection comes with a factory-applied, water-based "natural look" protectant that enhances the surface and aids in maintenance. However, to maintain its de-icing salt resistant properties, it is essential to re-apply a concrete or natural stone water-based protectant or sealer periodically.

We recommend applying the protectant as soon as you observe water absorption. If water is still repelled, re-application is not yet necessary. Always test the protectant or sealer on a small, hidden area before full application.



Please note that for barefoot walking areas (e.g. pool deck) dark-colored paving units could get very hot under the sun.



# TRAVERTINA RAW

DESCRIPTION: Slab TEXTURE: Klean-Bloc Brushed Travertine

20" x 10" - 20" x 20"

Specifications per pallet		Imperial	Metric
<b>A</b> 	Product dimension (L x W x H) <b>A</b>	20 x 10 x 2 ¼	508 x 254 x 57
	Product dimension (L x W x H) <b>B</b>	20 x 20 x 2 ¼	508 x 508 x 57
17 units / pallet	Cubing	70.83 ft <sup>3</sup>	6.58 m <sup>3</sup>
<b>B</b> 	Approx. Weight	1 812 lbs	822 kg
	Number of rows	1	
17 units / pallet	Coverage per unit <b>A</b>	1.39 ft <sup>2</sup>	0.13 m <sup>2</sup>
	Coverage per unit <b>B</b>	2.78 ft <sup>2</sup>	0.26m <sup>2</sup>
	Lin. coverage per row	42.5 lin. ft	12.95 lin. m

Pallet Overview - 20" x 20" and 20" x 10"

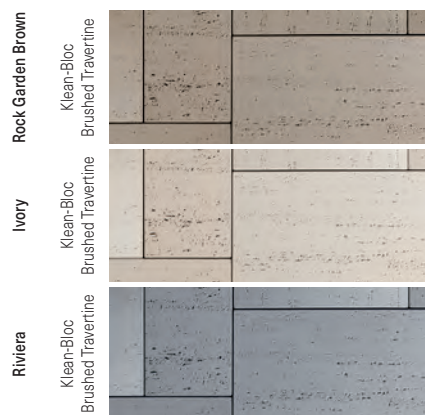
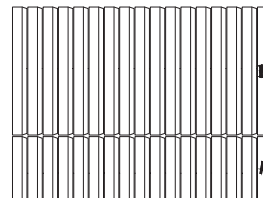

## Laying Patterns Options

01 | Modular

02 | Modular

03 | Linear

04 | Linear

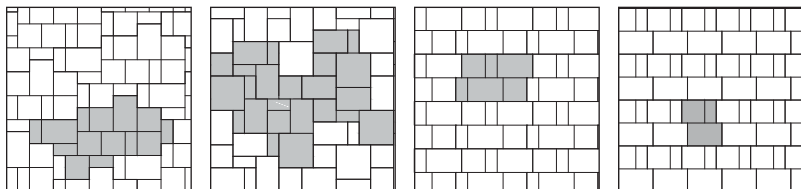

Patterns are for design inspiration only. The installer is responsible to calculate & purchase the correct amount of material.

## NOTES

Palletized upright.

See page 6 for icons description.

See page 26 for more information about applications.

See page 34 to 36 for more technical information.

\*For an authentic look, each color option is composed of a variety of darker & lighter tones. Natural ingredients such as granite are present within the recipe to allow for a range in tones, veining and textures from one stone to another.

Please note that for barefoot walking areas (e.g. pool deck) dark-colored paving units could get very hot under the sun.



# TRAVERTINA RAW

**DESCRIPTION:** Slab **TEXTURE:** Klean-Bloc Brushed Travertine

## Pallet Overview - 20" x 30"

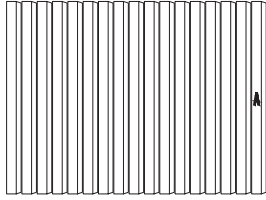

## Pallet Overview - 30" x 30"

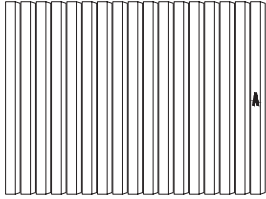

Klean-Bloc  
Brushed Travertine  
Rock Garden Brown

Klean-Bloc  
Brushed Travertine  
Ivory

Klean-Bloc  
Brushed Travertine  
Riviera

### 20" x 30"

#### Specifications per pallet

	Imperial	Metric	
 Product dimension (L x W x H)	20 x 30 x 2 1/4	508 x 762 x 57	
Cubing	70.83 ft <sup>2</sup>	6.58 m <sup>2</sup>	
17 units / pallet	Approx. Weight	1 822 lbs	
	Number of rows	1	
	Coverage per units	4.17 ft <sup>2</sup>	
	Lin. coverage	Depth	28.3 lin. ft
	per row	Length	42.5 lin. ft
			8.64 lin. m
			12.95 lin. m

### 30" x 30"

#### Specifications per pallet

	Imperial	Metric
 Product dimension (L x W x H)	30 x 30 x 2 1/4	762 x 762 x 57
Cubing	106.25 ft <sup>2</sup>	9.87 m <sup>2</sup>
17 units / pallet	Approx. Weight	2 667 lbs
	Number of rows	1
	Coverage per row	6.25 ft <sup>2</sup>
	Lin. coverage per row	42.5 lin. ft
		12.95 lin. m

## Laying Patterns Options

05 | Linear

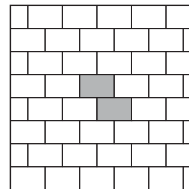

07 | Checkerboard

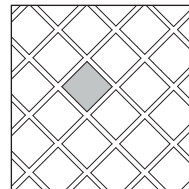

08 | Herringbone

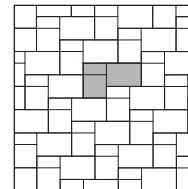

09 | Herringbone

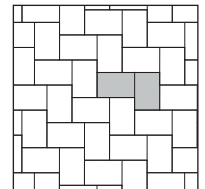

Patterns are for design inspiration only. The installer is responsible to calculate & purchase the correct amount of material.

## NOTES

Palletized upright.

See page 6 for icons description.

See page 26 for more information about applications.

See page 34 to 36 for more technical information.

\*For an authentic look, each color option is composed of a variety of darker & lighter tones. Natural ingredients such as granite are present within the recipe to allow for a range in tones, veining and textures from one stone to another.

In order to obtain a more realistic appearance to natural stone, wet cast (Stonedge collection) slabs are intended to have a slightly larger variance in their dimensions than dry cast slabs. See Notes for dimensional tolerances on page 34.

Please note that for barefoot walking areas (e.g. pool deck) dark-colored paving units could get very hot under the sun.

# PAVERS

DRIVEWAYS, PERMEABLE DRIVEWAYS & PATIOS



Antika	P. 65	Sleek	P. 93
Blu 80 mm	P. 66	Squadra	P. 94
Diamond	P. 71	Terrazzo	P. 95
Eva	P. 72	Valet	P. 96
Hexa	P. 73	Victorien	P. 97
Industria Series	P. 74	Villagio	P. 98
Linea	P. 90	Westmount	P. 99
Mista	P. 92		

## PHYSICAL AND GEOMETRICAL CHARACTERISTICS

CHARACTERISTICS	ASTM C936	CSA A231.2:19
Compressive strength	8000 psi [55 MPa] min.	50 MPa min.
Absorption	5 % max.	–
Freeze-thaw durability	Mass loss (max.): 225 g/m <sup>2</sup> at 28 cycles, or Mass loss (max.): 500 g/m <sup>2</sup> at 49 cycles	Mass loss (max.): 225 g/m <sup>2</sup> after 28 cycles, or Mass loss (max.): 500 g/m <sup>2</sup> after 49 cycles
Dimensional tolerances (see Notes below):	Length and Width: ± 0.063 in. [1.6 mm] Thickness: ± 0.125 in. [3.2 mm]	Length and Width: -1.0 mm to +2.0 mm Thickness: ± 3.0 mm

Notes: The dimensional tolerances shown above are prior to the application of architectural finishes.

# INSTALLATION GUIDE

## INTERLOCKING CONCRETE PAVEMENT

### INSTALLATION OUTLINE

#### 01 EXCAVATION

- A. Before excavating, call all the local utility companies (e.g., phone, gas, electrical) to ensure that the area in which you plan to dig is clear of underground cables or wires. If any are found, please notify the appropriate companies before you begin.
- B. When excavating, it is important to achieve a slope in increments of 1.5% ( $\frac{3}{8}$ " per ft/5 mm per 300 mm), which will allow for proper drainage. The excavation should mirror the final grade of pavement.
- C. The width of the base behind the edge should be equivalent to the thickness of the base.
- D. Using a rake, grade the bottom of the excavated area. If the natural soil is granular or sandy, we recommend that you compact the soil with a vibrating plate. If the soil is clay-like, change the soil with a blend of lime and crushed stone prior to compaction. Next, cover it with a layer of geotextile fabric to prevent the contamination of the base (clay and 0-  $\frac{3}{4}$ " [0-20 mm] crushed stone). Refer to the table "**Thickness of the Granular Foundation**" (on next page) to find the minimum thickness of foundation required.

#### 02 FOUNDATION

- A. Install a 0- $\frac{3}{4}$ " (0-20 mm) crushed stone base, in 4" (100 mm) lifts with a minimum 5,000 lbf (22 kN) vibrating plate compactor.
- B. To facilitate compacting, wet the base material thoroughly and compact with a vibrating plate proceeding in all directions. Continue this process until you have achieved the desired height. At this stage, you can verify the final height with the help of a paver.
- C. Base tolerance  $\pm\frac{3}{8}$ " (10 mm) for every 10' (3-m) increment.

#### 03 THE SETTING BED

- A. On the compacted crushed base, install two pipes with an outside diameter of 1" (25 mm). Grade the concrete sand with the help of a straight edge (or Quick-E leveler). If the base is not properly graded and smooth, imperfections will be evident in the finishing grade of the pavement.
- B. Bedding sand should not be compacted until all paving stones have been laid down. Passing the vibrating plate over the paving stones causes them to settle approximately  $\frac{3}{8}$ " (10 mm) into the bedding sand.

#### 04 INSTALLATION OF PAVING STONES

- A. Once the choice of paving stones and the design have been finalized, we recommended that you start installing the pavers at a 90-degree angle. To do so, proceed as follows: measure a first horizontal line of 3' (1-m) and a second line of 4' (1.2 m) perpendicular to the first. Connect a third straight line of 5' (1.5 m) which will form a triangle. The result will be a perfect 90-degree angle. While installing the paving stones, walk on the installed pavers, and fill in gaps caused by the pipes with concrete sand.
- B. It is always recommended that you use more than two cubes at a time in order to maximize the color blend. Furthermore, you should proceed with the cubes from top to bottom.
- C. You may use a chalk line to mark the stones to be cut along the borders, using a guillotine or a concrete saw. When cutting paving stones, we recommend that you wear protective ear and eyewear.
- D. Once you finish installing the paving stones, you can then install Avignon or Pietra curbstone on the granular base. To keep curbs in place, add mortar along the back to form a 45-degree angle between the ground and the curbstone or, when available, using the plastic retention system. In a vehicular traffic application, the mortar must be reinforced using steel rods.

#### 05 FILLING IN JOINTS

- A. Spread out the polymer stabilizer sand on the paving stones and sweep in between joints in all directions.
- B. Pass a vibrating plate in all directions to allow sand to penetrate between the joints.
- C. Sweep once more and remove excess sand. Follow the instructions exactly as indicated on the polymer stabilizer sand packaging.

# INSTALLATION GUIDE

## INTERLOCKING CONCRETE PAVEMENT



### VIBRATING PLATE ALERT!

Avoid scuffs on paver surfaces. Pavers with embossed surfaces (high and low points) are more susceptible to scuff marks from plate compactors. Techo-Bloc recommends the use of urethane mats between the plate and the paver surface when compacting. Techo-Bloc will not be held responsible for compaction scuffs or burns on pavers.

### THICKNESS OF THE GRANULAR FOUNDATION<sup>1</sup>

RESIDENTIAL PROJECTS	TYPE OF EXISTING SOIL	
	Clayey or Silty <sup>2</sup>	Sandy or Gravelly
Driveways <sup>3</sup>	8" to 14" (200 to 350 mm) Minimum	6" to 10" (150 to 250 mm) Minimum
Patios and Walkways <sup>4</sup>	6" to 8" (150 to 200 mm) Minimum	4" to 6" (100 to 150 mm) Minimum

- Data shown in this chart are provided as guidelines only. The range of values suggested depends particularly on existing soil conditions. The thicker the granular foundation, the greater the increase in stability of the whole structure.
- In the case of unstable soils or ones particularly affected by the freeze-thaw cycles, a thicker foundation may be necessary. For soils with these conditions or for commercial, industrial, or institutional works, a geotechnical professional should be consulted.
- For the province of Quebec, the typical range is:
  - For clayey or silty soils: 12" to 20"
  - For sandy or gravelly soils: 8" to 14"
- For the province of Quebec, the typical range is:
  - For clayey or silty soils: 10" to 14"
  - For sandy or gravelly soils: 6" to 8"

### QUANTITY CHART FOR JOINTS FILLING - FLEXLOCK POLYMERIC SAND Approximate surface coverage per bag of 50 lbs (22.7 kg).

PRODUCTS	sq. ft	sq. m			
Antika	21	2	Linea small rectangles	31.47	2.92
Blu 80 mm	76.5	7.11	Linea large rectangles	42.33	3.93
Blu 80 mm (6"×13")	31.97	2.97	Mika	16.41	1.53
Diamond	28.4	2.64	Mista random	50.4	4.69
Eva	143.56	13.34	Sleek	97.12	9.03
Hexa 100 mm	61.1	5.7	Squadra	14.50	1.35
Industria 150 series - 150 × 150	31.6	2.94	Terrazzo	127.9	11.9
Industria 200 series - 200 × 200	41.03	3.81	Valet	24.1	2.2
Industria 200 series - 200 × 400	54.57	5.07	Victorien 60 mm	97.06	9.02
Industria 300 series - 300 × 100	30.77	2.86	Villagio	18.50	1.72
Industria 300 series - 300 × 150	41	3.81	Westmount	25.3	2.4
Industria 300 series - 300 × 300	61.39	5.70			
Industria 450 series - 450 × 100	33.5	3.11			
Industria 450 series - 450 × 150	46.4	4.31			
Industria 450 series - 450 × 300	73.5	6.83			
Industria 600 series - 600 × 100	35.06	3.26			
Industria 600 series - 600 × 200	61.32	5.70			
Industria 600 series - 600 × 300	81.72	7.59			
Industria 600 series - 600 × 600	122.48	11.38			
Industria 900 series - 900 × 300	103.5	9.6			
Industria 900 series - 900 × 600	166.5	15.5			
Industria 900 series - 900 × 900	208.4	19.4			
Industria Triangle	36.0	3.3			
Industria Tactile	61.39	5.70			

Topsoil quantity in lb (kg) to cover an area of 1 sq.ft (1 sq.m) to fill in between joints and the paver cavity.

PRODUCTS	lbs/sq. ft	kg/sq. m
Aquastorm (see Permeable Pavers section)	12.60	61.40



# ANTIKA

**DESCRIPTION:** Paver **TEXTURE:** Smooth

### Pallet Overview\*

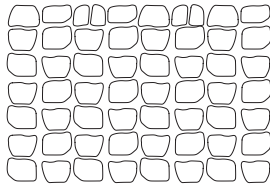

### Specifications per pallet

		Imperial	Metric
<b>A</b>		Product dimension (L x W x H) <b>A</b> Variable x 2 3/4"	Variable x 60
		Product dimension (L x W x H) <b>B</b> Variable x 2 3/4"	Variable x 60
<b>B</b>		Product dimension (L x W x H) <b>C</b> Variable x 2 3/4"	Variable x 60
		Product dimension (L x W x H) <b>D</b> Variable x 2 3/4"	Variable x 60
<b>C</b>		Product dimension (L x W x H) <b>E</b> Variable x 2 3/4"	Variable x 60
		Product dimension (L x W x H) <b>F</b> Variable x 2 3/4"	Variable x 60
<b>D</b>		Product dimension (L x W x H) <b>G</b> Variable x 2 3/4"	Variable x 60
		Cubing	87 ft <sup>2</sup> / 8.10 m <sup>2</sup>
		Approx. Weight	2 183 lbs / 990 kg
<b>E</b>		Number of rows	9
<b>F</b>		Coverage per row	9.67 ft <sup>2</sup> / 0.90m <sup>2</sup>
<b>G</b>			

### Laying Patterns Options

01 | Random

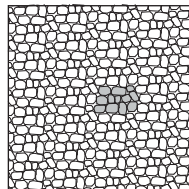

Patterns are for design inspiration only. The installer is responsible to calculate & purchase the correct amount of material.

### NOTES

The Antika paver is perfect as a filler in a circle, around a fan design or on a winding pathway. Antika can also be used as a mosaic frame around any design.

See page 6 for icons description.

See page 27 for more information about applications.

See page 62 to 64 for more technical information. When used in a permeable pavement application, see page 100 to 105 for more technical information.

**JOINT WIDTH:** variable  
**% OF SURFACE OPENING:** variable  
**INFILTRATION RATE:** 993 in./hr (25 227 mm/hr)

\*Pallet layout may vary.



Please note that for barefoot walking areas (e.g. pool deck) dark-colored paving units could get very hot under the sun.



# BLU 80 mm

DESCRIPTION: Paver TEXTURE: Slate and HD<sup>2</sup> Slate



Specifications per pallet		Imperial	Metric
<b>A</b>		Product dimension (L×W×H) <b>A</b> 6 ½ × 13 × 3 ½	165 × 330 × 80
	32 units / pallet	Product dimension (L×W×H) <b>B</b> 13 × 13 × 3 ½	330 × 330 × 80
<b>B</b>		Product dimension (L×W×H) <b>C</b> 19 ½ × 13 × 3 ½	495 × 330 × 80
	32 units / pallet	Cubing	84.96 ft <sup>2</sup> / 7.90 m <sup>2</sup>
<b>C</b>		Approx. Weight	3 246 lbs / 1 472 kg
	16 units / pallet	Number of rows	8
		Coverage per row	10.62 ft <sup>2</sup> / 0.99 m <sup>2</sup>
		Lin. coverage per row	9.75 lin. ft / 2.97 lin. m

## Pallet Overview

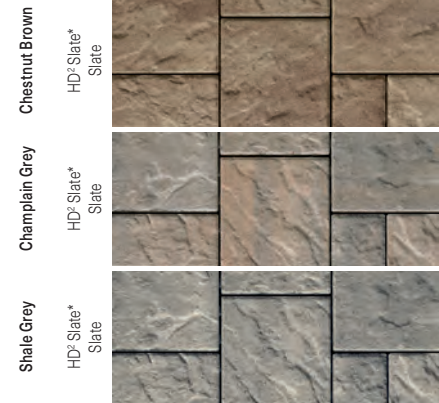
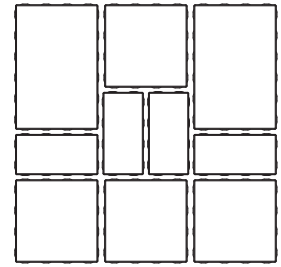

## Laying Patterns Options

01 | Modular

02 | Modular

03 | Linear

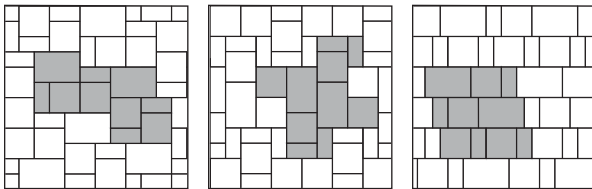

Patterns are for design inspiration only. The installer is responsible to calculate & purchase the correct amount of material.

## NOTES

See page 6 for icons description.

See page 27 for more information about applications.

See page 62 to 64 for more technical information. When used in a permeable pavement application, see page 100 to 105 for more technical information.

\*HD<sup>2</sup> Slate is only available in USA.

**JOINT WIDTH:** ½" (7 mm)  
**% OF SURFACE OPENING:** 4.5%\*\*  
**INFILTRATION RATE:** 570 in./hr (14 475 mm/hr)

\*\*For permeable application, the installation should be combined with Blu 6 × 13 in a modular pattern. A min. of 4.5% opening surface requires 75% of Blu 6 × 13 and 25% of Blu.

Please note that for barefoot walking areas (e.g. pool deck) dark-colored paving units could get very hot under the sun.



# BLU 80 mm

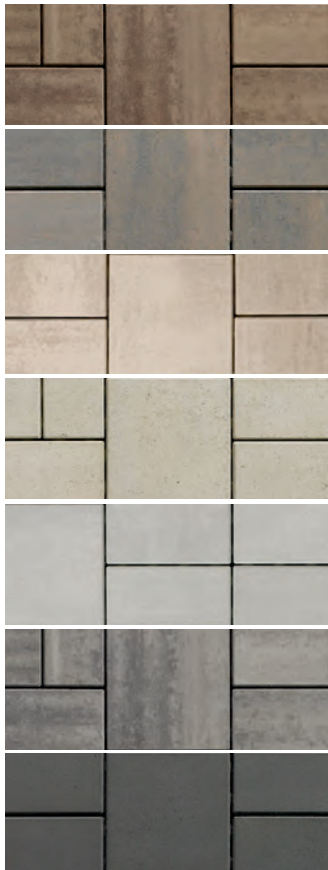
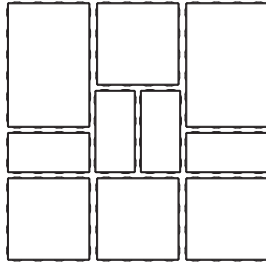

DESCRIPTION: Paver TEXTURE: Smooth and HD² Smooth

## Pallet Overview



HD² Smooth Smooth Chestnut Brown  
 HD² Smooth Smooth Champlain Grey  
 HD² Smooth Caffè crema  
 Smooth Beige Cream  
 HD² Smooth Smooth Greyed Nickel  
 HD² Smooth Smooth Shale Grey  
 HD² Smooth Onyx Black

## Specifications per pallet

	Imperial	Metric
<b>A</b>  Product dimension (L x W x H) <b>A</b>	6 1/2 x 13 x 3 1/8	165 x 330 x 80
32 units / pallet		
<b>B</b>  Product dimension (L x W x H) <b>B</b>	13 x 13 x 3 1/8	330 x 330 x 80
32 units / pallet		
<b>C</b>  Product dimension (L x W x H) <b>C</b>	19 1/2 x 13 x 3 1/8	495 x 330 x 80
16 units / pallet		
Cubing	84.96 ft²	7.90 m²
Approx. Weight Smooth	3 095 lbs	1 404 kg
Approx. Weight HD² Smooth	3 280 lbs	1 488 kg
Number of rows	8	
Coverage per row	10.62 ft²	0.99 m²
Lin. coverage per row	9.75 lin. ft	2.97 lin. m

## Laying Patterns Options

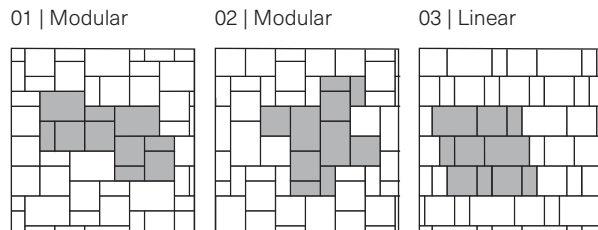

Patterns are for design inspiration only. The installer is responsible to calculate & purchase the correct amount of material.

## NOTES

See page 6 for icons description.  
 See page 27 for more information about applications.  
 See page 62 to 64 for more technical information. When used in a permeable pavement application, see page 100 to 105 for more technical information.

**JOINT WIDTH:** 3/32" (7 mm)  
**% OF SURFACE OPENING:** 4.5%\*  
**INFILTRATION RATE:** 570 in./hr (14 475 mm/hr)

\*For permeable application, the installation should be combined with Blu 6 x 13 in a modular pattern. A min. of 4.5% opening surface requires 75% of Blu 6 x 13 and 25% of Blu.



Please note that for barefoot walking areas (e.g. pool deck) dark-colored paving units could get very hot under the sun.

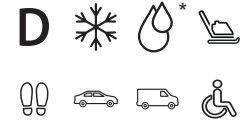

## BLU 80 mm

DESCRIPTION: Paver TEXTURE: Polished



Specifications per pallet		Imperial	Metric
<b>A</b>	 Product dimension (L x W x H) <b>A</b>	6 1/2 x 13 x 2 15/16	165 x 330 x 75
	32 units / pallet		
<b>B</b>	 Product dimension (L x W x H) <b>B</b>	13 x 13 x 2 15/16	330 x 330 x 75
	32 units / pallet		
<b>C</b>	 Product dimension (L x W x H) <b>C</b>	19 1/2 x 13 x 2 15/16	495 x 330 x 75
	16 units / pallet		
	Cubing	84.96 ft <sup>2</sup>	7.90 m <sup>2</sup>
	Approx. Weight	3 042 lbs	1 380 kg
	Number of rows	8	
	Coverage per row	10.62 ft <sup>2</sup>	0.99 m <sup>2</sup>
	Lin. coverage per row	9.75 lin. ft	2.97 lin. m

### Pallet Overview

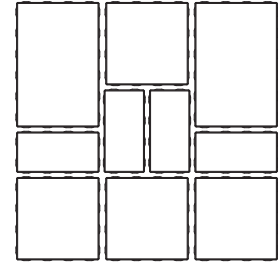

### Laying Patterns Options

01 | Modular

02 | Modular

03 | Linear

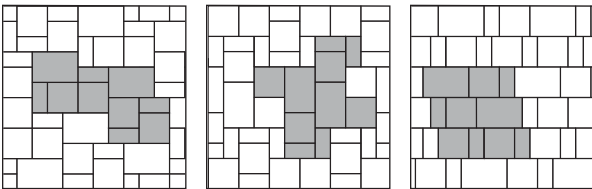

Patterns are for design inspiration only. The installer is responsible to calculate & purchase the correct amount of material.

### NOTES

See page 6 for icons description.

See page 27 for more information about applications.

See page 62 to 64 for more technical information. When used in a permeable pavement application, see page 100 to 105 for more technical information.

**Polished is made-to-order, minimum order of 500 sq. ft. Deposit required.**

**JOINT WIDTH:** 5/32" (7 mm)

**% OF SURFACE OPENING:** 4.5%\*

**INFILTRATION RATE:** 570 in./hr (14 475 mm/hr)

\*For permeable application, the installation should be combined with Blu 6 x 13 in a modular pattern. A min. of 4.5% opening surface requires 75% of Blu 6 x 13 and 25% of Blu.

Please note that for barefoot walking areas (e.g. pool deck) dark-colored paving units could get very hot under the sun.

Chestnut Brown

Polished



Beige Cream

Polished



Grayed Nickel

Polished

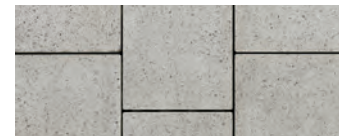

Shale Grey

Polished



Onyx Black

Polished

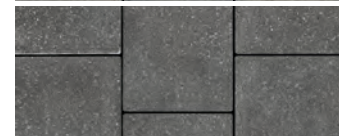



# BLU 80 mm (6" × 13")

DESCRIPTION: Paver TEXTURE: Slate, HD² Slate

## Pallet Overview

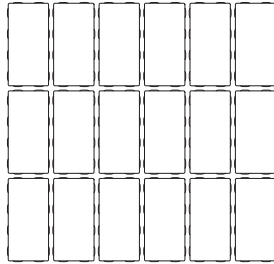

## Specifications per pallet



144 units / pallet

		Imperial	Metric
Product dimension (L × W × H)		6 ½ × 13 × 3 ½	165 × 330 × 80
Cubing		84.40 ft²	7.84 m²
Approx. Weight		3 133 lbs	1 421 kg
Number of rows		8	
Coverage per row		10.55 ft²	0.98 m²
Lin. coverage per row	Depth	19.49 lin. ft	5.94 lin. m
	Length	9.74 lin. ft	2.97 lin. m



Slate  
Chocolate Brown  
HD² Slate\*  
Slate  
Chestnut Brown  
HD² Slate\*  
Slate  
Champlain Grey  
HD² Slate\*  
Slate  
Shale Grey  
HD² Slate\*  
Slate  
Onyx Black

## Laying Patterns Options

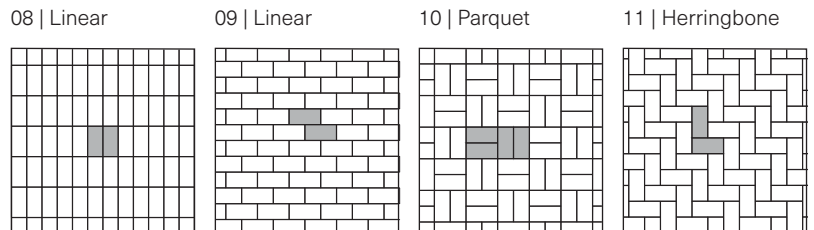

Patterns are for design inspiration only. The installer is responsible to calculate & purchase the correct amount of material.

## NOTES

See page 6 for icons description.

See page 27 for more information about applications.

See page 62 to 64 for more technical information. When used in a permeable pavement application, see page 100 to 105 for more technical information.

\*HD² Slate is only available in USA.

**JOINT WIDTH:** ½" (7 mm)  
**% OF SURFACE OPENING:** 4.8%  
**INFILTRATION RATE:** 570 in./hr (14 475 mm/hr)

Please note that for barefoot walking areas (e.g. pool deck) dark-colored paving units could get very hot under the sun.



# BLU 80 mm (6"×13")

DESCRIPTION: Paver TEXTURE: Smooth, HD<sup>2</sup> Smooth

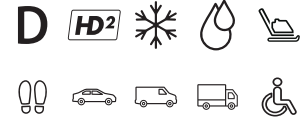

Specifications per pallet		Imperial	Metric
	Product dimension (L×W×H)	6 ½ × 13 × 3 ½	165 × 330 × 80
	Cubing	84.40 ft <sup>2</sup>	7.84 m <sup>2</sup>
144 units / pallet	Approx. Weight	3 133 lbs	1 421 kg
	Number of rows	8	
	Coverage per row	10.55 ft <sup>2</sup>	0.98 m <sup>2</sup>
Lin. coverage per row	Depth	19.49 lin. ft	5.94 lin. m
	Length	9.74 lin. ft	2.97 lin. m

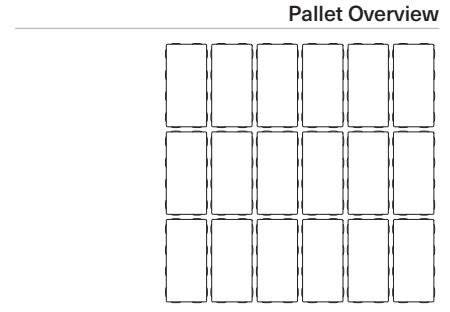

## Laying Patterns Options

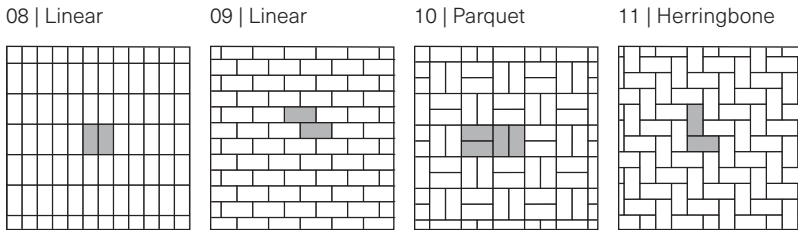

Patterns are for design inspiration only. The installer is responsible to calculate & purchase the correct amount of material.

## NOTES

See page 6 for icons description.

See page 27 for more information about applications.

See page 62 to 64 for more technical information. When used in a permeable pavement application, see page 100 to 105 for more technical information.

**JOINT WIDTH:** ½" (7 mm)  
**% OF SURFACE OPENING:** 4.8%  
**INFILTRATION RATE:** 570 in./hr (14 475 mm/hr)

Please note that for barefoot walking areas (e.g. pool deck) dark-colored paving units could get very hot under the sun.

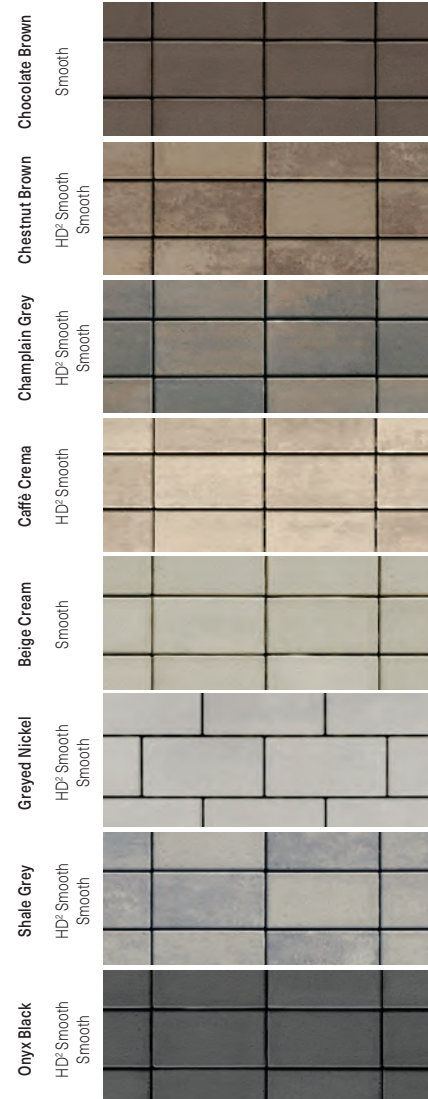



# DIAMOND

DESCRIPTION: Paver TEXTURE: HD² Smooth or HD² Granitex

## Pallet Overview

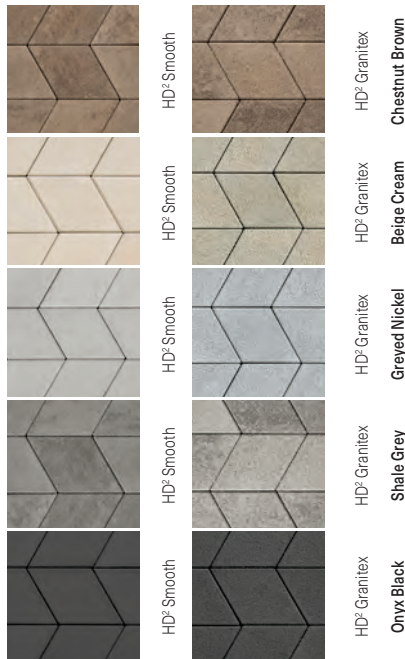
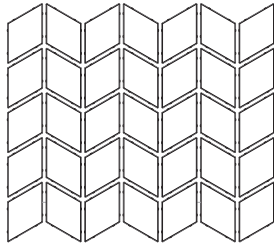

## Specifications per pallet

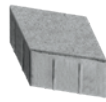

245 units / pallet

	Imperial	Metric
Product dimension(L x W x H)	6 3/16 x 7 1/8 x 3 15/16	156 x 181 x 100
Diagonal	12 5/16	313
Cubing	74.47 ft²	6.92 m²
Approx. Weight	3 469 lbs	1 573 kg
Number of rows	7	
Coverage per row	10.64 ft²	0.99 m²
Lin. coverage per row	Depth 20.74 lin. ft	6.32 lin. m
	Length 17.79 lin. ft	5.42 lin. m

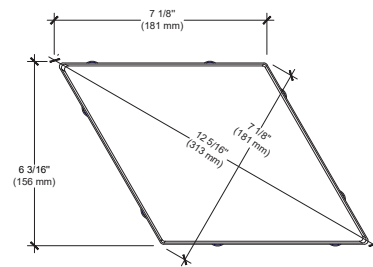

## Laying Patterns Options

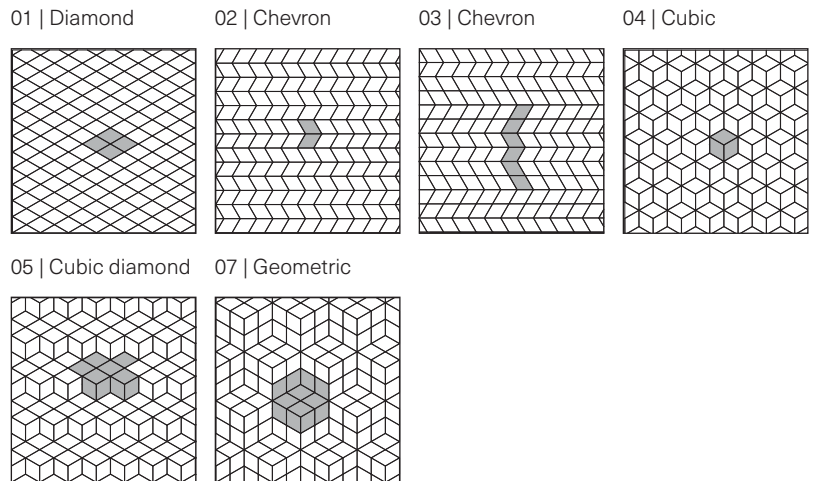

Patterns are for design inspiration only. The installer is responsible to calculate & purchase the correct amount of material.

## NOTES

See page 6 for icons description.  
 See page 27 for more information about applications.  
 See page 62 to 64 for more technical information.  
 Due to its unique geometry, this product may require extra care to ensure proper alignment during installation. Careful setup helps achieve a clean and consistent finish.



**HD² Granitex is made-to-order, minimum order of 500 sq. ft. Deposit required.**  
 Please note that for barefoot walking areas (e.g. pool deck) dark-colored paving units could get very hot under the sun.



# EVA

DESCRIPTION: Paver TEXTURE: Slate and Smooth



Specifications per pallet		Imperial	Metric
<b>A</b> 	Product dimension (L×W×H) <b>A</b>	4 3/8 × 8 3/4 × 2 3/8	112 × 223 × 60
	Product dimension (L×W×H) <b>B</b>	8 3/4 × 8 3/4 × 2 3/8	223 × 223 × 60
	Product dimension (L×W×H) <b>C</b>	13 3/16 × 8 3/4 × 2 3/8	335 × 223 × 60
<b>B</b> 	Cubing	132.48 ft <sup>2</sup>	12.31 m <sup>2</sup>
	Approx. Weight	3 643 lbs	1 653 kg
	Number of rows	11	
<b>C</b> 	Coverage per row	12.04 ft <sup>2</sup>	1.12 m <sup>2</sup>
	Lin. coverage per row	16.46 lin. ft	5.02 lin. m

## Pallet Overview

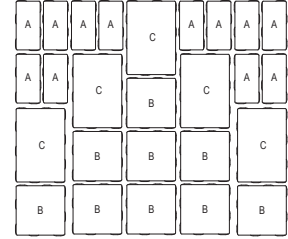

## Laying Patterns Options

01 | Modular

02 | Linear

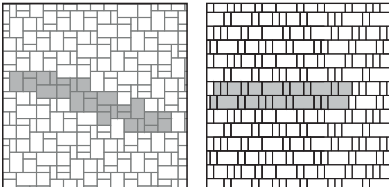

Patterns are for design inspiration only. The installer is responsible to calculate & purchase the correct amount of material.



## NOTES

See page 6 for icons description.

See page 27 for more information about applications.

See page 62 to 64 for more technical information.

Please note that for barefoot walking areas (e.g. pool deck) dark-colored paving units could get very hot under the sun.

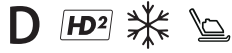

# HEXA 100 mm

DESCRIPTION: Paver TEXTURE: HD² Smooth

## Pallet Overview

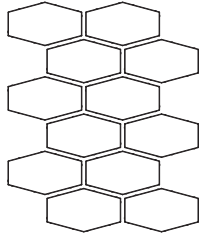

## Specifications per pallet



84 units / pallet

	Imperial	Metric
Product dimension (L x W x H)	15 3/16" x 9" x 3 15/16"	385 x 228 x 100
Cubing	61.44 ft²	5.71 m²
Approx. Weight	2 980 lbs	1 352 kg
Number of rows	7	
Coverage per row	8.78 ft²	0.82 m²

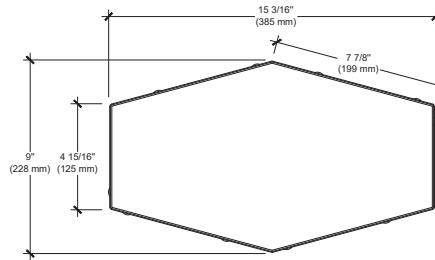

HD² Smooth  
Chestnut Brown



HD² Smooth  
Beige Cream



HD² Smooth  
Greyed Nickel



HD² Smooth  
Shale Grey



HD² Smooth  
Onyx Black

## Laying Patterns Options

01 | Hexagon

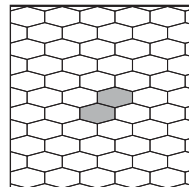

Patterns are for design inspiration only. The installer is responsible to calculate & purchase the correct amount of material.

## NOTES

See page 6 for icons description.

See page 27 for more information about applications.

See page 62 to 64 for more technical information.

Please note that for barefoot walking areas (e.g. pool deck) dark-colored paving units could get very hot under the sun.



# INDUSTRIA 150 Series

DESCRIPTION: Paver TEXTURE: HD<sup>2</sup> Smooth or HD<sup>2</sup> Granitex

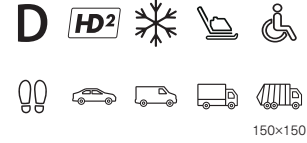

150x150

150 x 150		Imperial	Metric
<b>Specifications per pallet</b>			
 294 units / pallet	Product dimension (L x W x H)	5 7/8 x 5 7/8 x 3 15/16	150 x 150 x 100
	Cubing	71.20 ft <sup>2</sup>	6.62 m <sup>2</sup>
	Approx. Weight	3 357 lbs	1 523 kg
	Number of rows	7	
	Coverage per row	10.17 ft <sup>2</sup>	0.95 m <sup>2</sup>
	Linear coverage per row	20.67 lin. ft	6.30 lin. m

## Pallet Overview - 150 x 150

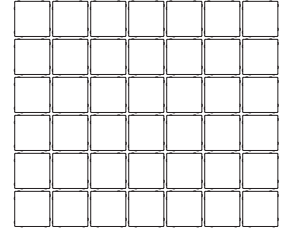

## Laying Patterns Options

01 | Linear

02 | Linear

24 | Modular

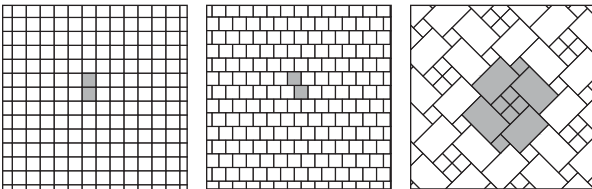

Patterns are for design inspiration only. The installer is responsible to calculate & purchase the correct amount of material.

## NOTES

See page 6 for icons description.

See page 27 for more information about applications.

See page 62 to 64 for more technical information.

Please note that for barefoot walking areas (e.g. pool deck) dark-colored paving units could get very hot under the sun.

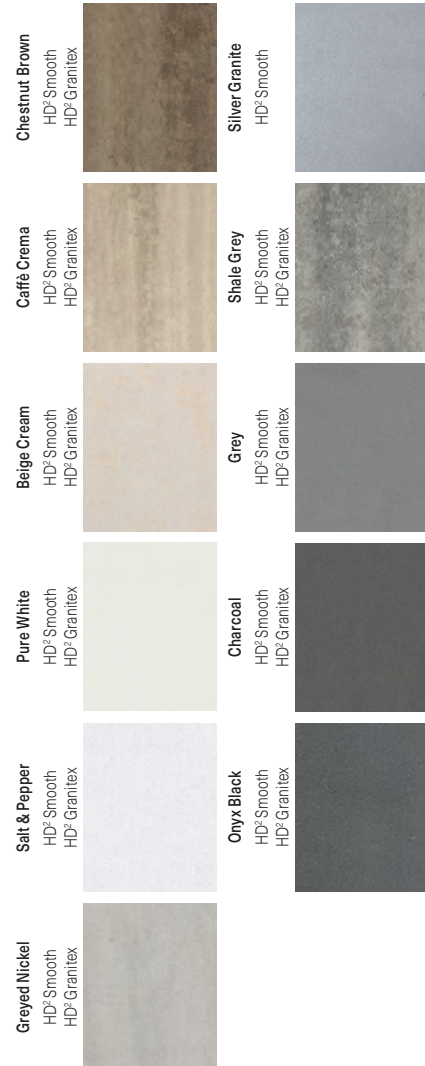

See page 22 for list of In-Stock or On order colors for all items of Industria Collection.

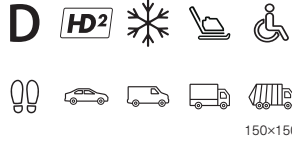

# INDUSTRIA 150 Series

DESCRIPTION: Paver TEXTURE: HD<sup>2</sup> Polished

## Pallet Overview - 150 x 150

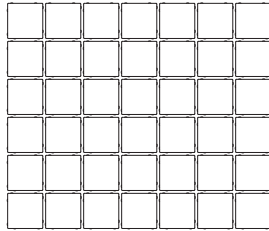

150 x 150

### Specifications per pallet



294 units / pallet

	Imperial	Metric
Product dimension (L x W x H)	5 7/8 x 5 7/8 x 3 3/4	150 x 150 x 95
Cubing	71.20 ft <sup>3</sup>	6.62 m <sup>3</sup>
Approx. Weight	3 357 lbs	1 523 kg
Number of rows	7	
Coverage per row	10.17 ft <sup>2</sup>	0.95 m <sup>2</sup>
Linear coverage per row	20.67 lin. ft	6.30 lin. m



## Laying Patterns Options

01 | Linear

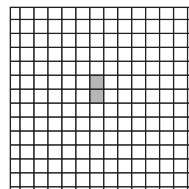

02 | Linear

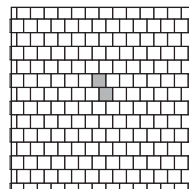

24 | Modular

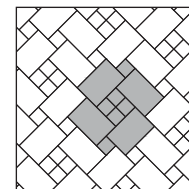

Patterns are for design inspiration only. The installer is responsible to calculate & purchase the correct amount of material.

## NOTES

See page 6 for icons description.  
 See page 27 for more information about applications.  
 See page 62 to 64 for more technical information.

Please note that for barefoot walking areas (e.g. pool deck) dark-colored paving units could get very hot under the sun.

See page 22 for list of In-Stock or On order colors for all items of Industria Collection.



# INDUSTRIA 200 Series

DESCRIPTION: Paver TEXTURE: HD<sup>2</sup> Smooth or HD<sup>2</sup> Granitex

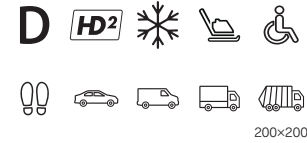

200 x 200			
Specifications per pallet		Imperial	Metric
 140 units / pallet	Product dimension (L x W x H)	7 7/8 x 7 7/8 x 3 15/16	200 x 200 x 100
	Cubing	60.28 ft <sup>2</sup>	5.60 m <sup>2</sup>
	Approx. Weight	2 863 lbs	1 299 kg
	Number of rows	7	
	Coverage per row	8.61 ft <sup>2</sup>	0.80 m <sup>2</sup>
	Linear coverage per row	13.12 lin. ft	4 lin. m

200 x 400			
Specifications per pallet		Imperial	Metric
 70 units / pallet	Product dimension (L x W x H)	7 7/8 x 15 3/4 x 3 15/16	200 x 400 x 100
	Cubing	60.28 ft <sup>2</sup>	5.60 m <sup>2</sup>
	Approx. Weight	2 862 lbs	1 298 kg
	Number of rows	7	
	Coverage per row	8.61 ft <sup>2</sup>	0.80 m <sup>2</sup>
	Lin. coverage per row	Depth 6.56 lin. ft Length 13.12 lin. ft	2 lin. m 4 lin. m

## Laying Patterns Options

03 | Linear

04 | Linear

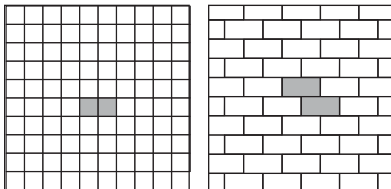

Patterns are for design inspiration only. The installer is responsible to calculate & purchase the correct amount of material.

## NOTES

See page 6 for icons description.  
 See page 27 for more information about applications.  
 See page 62 to 64 for more technical information.

Please note that for barefoot walking areas (e.g. pool deck) dark-colored paving units could get very hot under the sun.

### Pallet Overview - 200 x 200

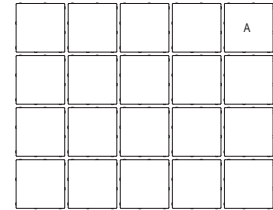

### Pallet Overview - 200 x 400

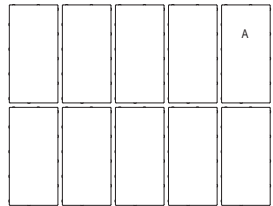

See page 22 for list of In-Stock or On order colors for all items of Industria Collection.

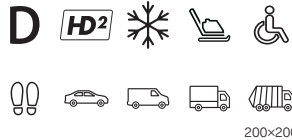

# INDUSTRIA 200 Series

DESCRIPTION: Paver TEXTURE: HD² Polished

## Pallet Overview - 200 x 200

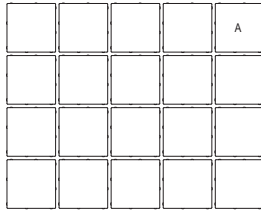

## Pallet Overview - 200 x 400

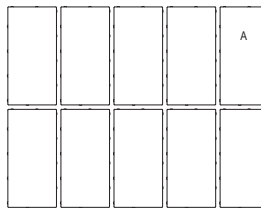

## 200 x 200

Specifications per pallet	Imperial	Metric
 Product dimension (L x W x H)	7 7/8 x 7 7/8 x 3 3/4	200 x 200 x 95
Cubing	60.28 ft²	5.60 m²
140 units / pallet	Approx. Weight	2 848 lbs / 1 292 kg
	Number of rows	7
	Coverage per row	8.61 ft² / 0.80 m²
	Linear coverage per row	13.12 lin. ft / 4 lin. m

## 200 x 400

Specifications per pallet	Imperial	Metric
 Product dimension (L x W x H)	7 7/8 x 15 3/4 x 3 3/4	200 x 400 x 95
Cubing	60.28 ft²	5.60 m²
70 units / pallet	Approx. Weight	2 848 lbs / 1 292 kg
	Number of rows	7
	Coverage per row	8.61 ft² / 0.80 m²
Lin. coverage per row	Depth	6.56 lin. ft / 2 lin. m
	Length	13.12 lin. ft / 4 lin. m

## Laying Patterns Options

05 | Linear

06 | Linear

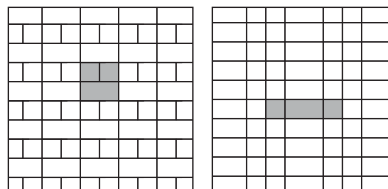

Patterns are for design inspiration only. The installer is responsible to calculate & purchase the correct amount of material.

## NOTES

See page 6 for icons description.  
 See page 27 for more information about applications.  
 See page 62 to 64 for more technical information.

Please note that for barefoot walking areas (e.g. pool deck) dark-colored paving units could get very hot under the sun.

See page 22 for list of In-Stock or On order colors for all items of Industria Collection.



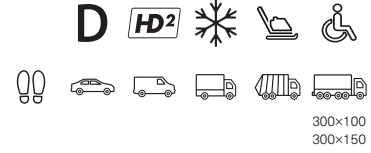

# INDUSTRIA 300 Series

DESCRIPTION: Paver TEXTURE: HD<sup>2</sup> Smooth or HD<sup>2</sup> Granitex



300 x 100		Imperial	Metric
 <p>231 units / pallet</p>	Specifications per pallet		
	Product dimension (L x W x H)	11 1 <sup>5</sup> / <sub>16</sub> x 3 1 <sup>5</sup> / <sub>16</sub> x 3 1 <sup>5</sup> / <sub>16</sub>	300 x 100 x 100
	Cubing	74.59 ft <sup>2</sup>	6.93 m <sup>2</sup>
	Approx. Weight	3 412 lbs	1 548 kg
	Number of rows	7	
	Coverage per row	10.66 ft <sup>2</sup>	0.99 m <sup>2</sup>
	Lin. coverage per row	Depth 32.48 lin. ft Length 10.83 lin. ft	9.90 lin. m 3.30 lin. m

300 x 150		Imperial	Metric
 <p>147 units / pallet</p>	Specifications per pallet		
	Product dimension (L x W x H)	11 1 <sup>5</sup> / <sub>16</sub> x 5 7 <sup>7</sup> / <sub>8</sub> x 3 1 <sup>5</sup> / <sub>16</sub>	300 x 150 x 100
	Cubing	71.20 ft <sup>2</sup>	6.62 m <sup>2</sup>
	Approx. Weight	3 288 lbs	1 491 kg
	Number of rows	7	
	Coverage per row	10.17 ft <sup>2</sup>	0.95 m <sup>2</sup>
	Lin. coverage per row	Depth 20.67 lin. ft Length 10.33 lin. ft	6.30 lin. m 3.15 lin. m

300 x 300		Imperial	Metric
 <p>84 units / pallet</p>	Specifications per pallet		
	Product dimension (L x W x H)	11 1 <sup>5</sup> / <sub>16</sub> x 11 1 <sup>5</sup> / <sub>16</sub> x 3 1 <sup>5</sup> / <sub>16</sub>	300 x 300 x 100
	Cubing	81.38 ft <sup>2</sup>	7.56 m <sup>2</sup>
	Approx. Weight	3 725 lbs	1 690 kg
	Number of rows	7	
	Coverage per row	11.63 ft <sup>2</sup>	1.08 m <sup>2</sup>
	Linear coverage per row	11.81 lin. ft	3.60 lin. m

## Laying Patterns Options

07 | Linear

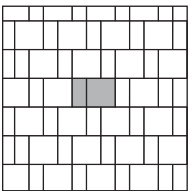

Patterns are for design inspiration only. The installer is responsible to calculate & purchase the correct amount of material.

## NOTES

See page 6 for icons description.

See page 27 for more information about applications.

See page 62 to 64 for more technical information.

Please note that for barefoot walking areas (e.g. pool deck) dark-colored paving units could get very hot under the sun.

### Pallet Overview - 300 x 100

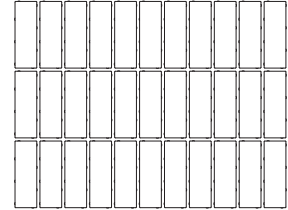

### Pallet Overview - 300 x 150

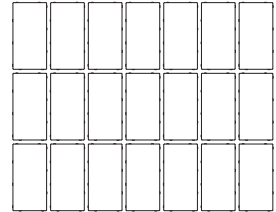

### Pallet Overview - 300 x 300

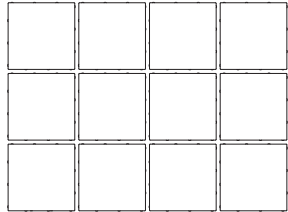

Greyed Nickel HD <sup>2</sup> Smooth HD <sup>2</sup> Granitex	Onyx Black HD <sup>2</sup> Smooth HD <sup>2</sup> Granitex	Salt & Pepper HD <sup>2</sup> Smooth HD <sup>2</sup> Granitex	Pure White HD <sup>2</sup> Smooth HD <sup>2</sup> Granitex	Beige Cream HD <sup>2</sup> Smooth HD <sup>2</sup> Granitex	Caffè Crema HD <sup>2</sup> Smooth HD <sup>2</sup> Granitex	Chestnut Brown HD <sup>2</sup> Smooth HD <sup>2</sup> Granitex	Silver Granite HD <sup>2</sup> Smooth	Shale Grey HD <sup>2</sup> Smooth HD <sup>2</sup> Granitex	Grey HD <sup>2</sup> Smooth HD <sup>2</sup> Granitex	Charcoal HD <sup>2</sup> Smooth HD <sup>2</sup> Granitex
---	--	---	--	---	---	--	--	--	--	--

See page 22 for list of In-Stock or On order colors for all items of Industria Collection.

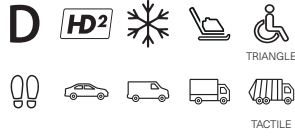

# INDUSTRIA 300 Series

**DESCRIPTION:** Paver **Texture:** HD<sup>2</sup> Smooth or HD<sup>2</sup> Granitex

## Pallet Overview - Tactile

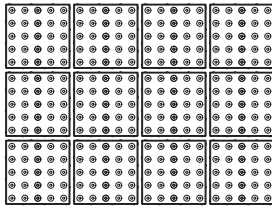

## Pallet Overview - Triangle

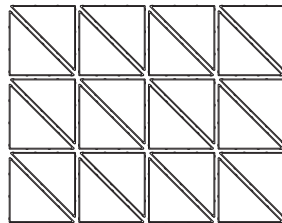

TACTILE*	TRIANGLE	
		HD <sup>2</sup> Smooth HD <sup>2</sup> Granitex Chestnut Brown
		HD <sup>2</sup> Smooth HD <sup>2</sup> Granitex Caffè Crema
		HD <sup>2</sup> Smooth HD <sup>2</sup> Granitex Beige Cream
		HD <sup>2</sup> Smooth HD <sup>2</sup> Granitex Pure White
		HD <sup>2</sup> Smooth HD <sup>2</sup> Granitex Salt & Pepper
		HD <sup>2</sup> Smooth HD <sup>2</sup> Granitex Greyed Nickel
		HD <sup>2</sup> Smooth HD <sup>2</sup> Granitex Silver Granite
		HD <sup>2</sup> Smooth HD <sup>2</sup> Granitex Shale Grey
		HD <sup>2</sup> Smooth HD <sup>2</sup> Granitex Grey
		HD <sup>2</sup> Smooth HD <sup>2</sup> Granitex Charcoal
		HD <sup>2</sup> Smooth HD <sup>2</sup> Granitex Onyx Black

## TACTILE

### Specifications per pallet



84 units / pallet

	Imperial	Metric
Product dimension (L x W x H)	11 13/16" x 11 13/16" x 3 15/16"	300 x 300 x 100
Cubing	81.38 ft <sup>2</sup>	7.56 m <sup>2</sup>
Approx. Weight	3 725 lbs	1 690 kg
Number of rows	7	
Coverage per row	11.63 ft <sup>2</sup>	1.08 m <sup>2</sup>
Lin. coverage per row	11.81 lin. ft	3.60 lin. m

## TRIANGLE

### Specifications per pallet



168 units / pallet

	Imperial	Metric
Product dimension (L x W x H)	11 13/16" x 11 13/16" x 3 15/16"	300 x 300 x 100
Cubing	81.38 ft <sup>2</sup>	7.56 m <sup>2</sup>
Approx. Weight	3 743 lbs	1 698 kg
Number of rows	7	
Coverage per row	11.63 ft <sup>2</sup>	1.08 m <sup>2</sup>
Lin. coverage per row	11.81 lin. ft	3.60 lin. m

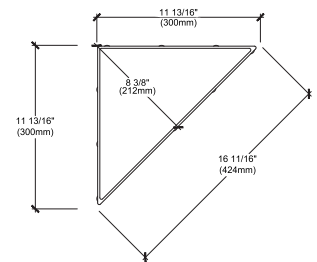

## Laying Patterns Options

01 | Linear

03 | Linear

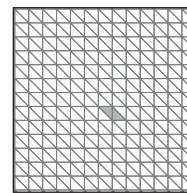
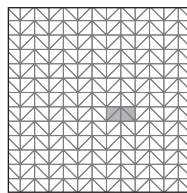

Patterns are for design inspiration only. The installer is responsible to calculate & purchase the correct amount of material.

## NOTES

See page 6 for icons description.

See page 27 for more information about applications.

See page 62 to 64 for more technical information.

Triangle: Due to its unique geometry, this product may require extra care to ensure proper alignment during installation. Careful setup helps achieve a clean and consistent finish.

\*Industria Tactile is only available in HD<sup>2</sup> Smooth.

Please note that for barefoot walking areas (e.g. pool deck) dark-colored paving units could get very hot under the sun.

See page 22 for list of In-Stock or On order colors for all items of Industria Collection.



# INDUSTRIA 300 Series

DESCRIPTION: Paver TEXTURE: HD<sup>2</sup> Polished

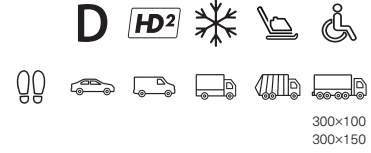

300 × 100		Imperial	Metric	
<b>Specifications per pallet</b>				
 231 units / pallet	Product dimension (L × W × H)	11 13/16 × 3 15/16 × 3 3/4	300 × 100 × 95	
	Cubing	74.59 ft <sup>2</sup>	6.93 m <sup>2</sup>	
	Approx. Weight	3 412 lbs	1 548 kg	
	Number of rows	7		
	Coverage per row	10.66 ft <sup>2</sup>	0.99 m <sup>2</sup>	
	Lin. coverage	Depth	32.48 lin. ft	9.90 lin. m
	per row	Length	10.83 lin. ft	3.30 lin. m

300 × 150		Imperial	Metric	
<b>Specifications per pallet</b>				
 147 units / pallet	Product dimension (L × W × H)	11 13/16 × 5 7/8 × 3 3/4	300 × 150 × 95	
	Cubing	71.20 ft <sup>2</sup>	6.62 m <sup>2</sup>	
	Approx. Weight	3 288 lbs	1 491 kg	
	Number of rows	7		
	Coverage per row	10.17 ft <sup>2</sup>	0.95 m <sup>2</sup>	
	Lin. coverage	Depth	20.67 lin. ft	6.30 lin. m
	per row	Length	10.33 lin. ft	3.15 lin. m

### Pallet Overview - 300 × 100

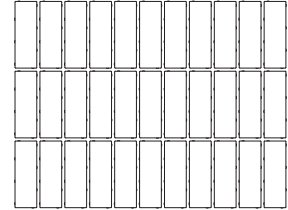

### Pallet Overview - 300 × 150

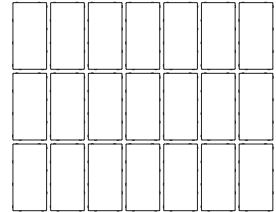

## Laying Patterns Options

09 | Linear

10 | Linear

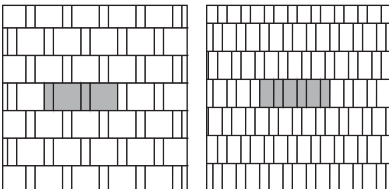

Patterns are for design inspiration only. The installer is responsible to calculate & purchase the correct amount of material.

## NOTES

See page 6 for icons description.

See page 27 for more information about applications.

See page 62 to 64 for more technical information.

Please note that for barefoot walking areas (e.g. pool deck) dark-colored paving units could get very hot under the sun.



See page 22 for list of In-Stock or On order colors for all items of Industria Collection.



# INDUSTRIA 300 Series

DESCRIPTION: Paver TEXTURE: HD² Polished

## Pallet Overview - 300 x 300

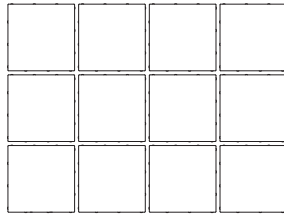

## Pallet Overview - Triangle

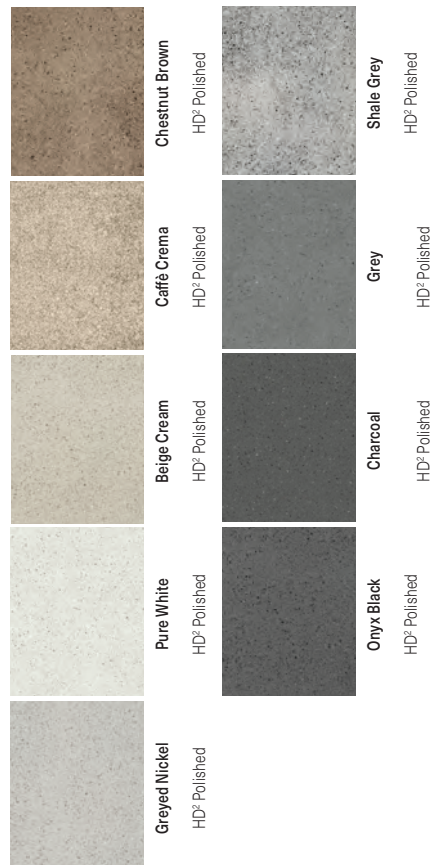
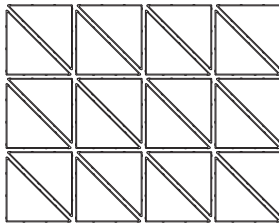

See page 22 for list of In-Stock or On order colors for all items of Industria Collection.

### 300 x 300

#### Specifications per pallet



84 units / pallet

	Imperial	Metric
Product dimension (L x W x H)	11 13/16" x 11 13/16" x 3 3/4"	300 x 300 x 95
Cubing	81.38 ft²	7.56 m²
Approx. Weight	3 725 lbs	1 690 kg
Number of rows	7	
Coverage per row	11.63 ft²	1.08 m²
Linear coverage per row	11.81 lin. ft	3.60 lin. m

### TRIANGLE

#### Specifications per pallet



168 units / pallet

	Imperial	Metric
Product dimension (L x W x H)	11 13/16" x 11 13/16" x 3 3/4"	300 x 300 x 95
Cubing	81.38 ft²	7.56 m²
Approx. Weight	3 743 lbs	1 698 kg
Number of rows	7	
Coverage per row	11.63 ft²	1.08 m²
Lin. coverage per row	11.81 lin. ft	3.60 lin. m

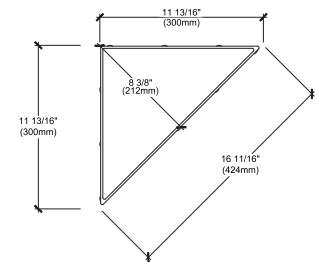

## Laying Patterns Options

01 | Linear

03 | Linear

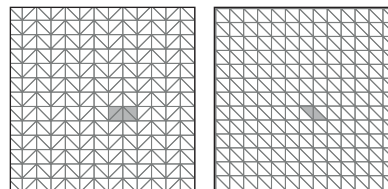

Patterns are for design inspiration only. The installer is responsible to calculate & purchase the correct amount of material.

## NOTES

See page 6 for icons description.

See page 27 for more information about applications.

See page 62 to 64 for more technical information.

Triangle: Due to its unique geometry, this product may require extra care to ensure proper alignment during installation. Careful setup helps achieve a clean and consistent finish.

Please note that for barefoot walking areas (e.g. pool deck) dark-colored paving units could get very hot under the sun.



# INDUSTRIA 450 Series

DESCRIPTION: Paver TEXTURE: HD<sup>2</sup> Smooth or HD<sup>2</sup> Granitex

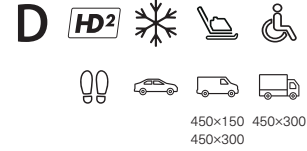

## 450 x 100

Specifications per pallet		Imperial	Metric
 154 units / pallet	Product dimension (L x W x H)	17 <sup>1</sup> / <sub>16</sub> x 3 <sup>15</sup> / <sub>16</sub> x 3 <sup>15</sup> / <sub>16</sub>	450 x 100 x 100
	Cubing	74.59 ft <sup>2</sup>	6.93 m <sup>2</sup>
	Approx. Weight	3 516 lbs	1 595 kg
	Number of rows	7	
	Coverage per row	10.66 ft <sup>2</sup>	0.99 m <sup>2</sup>
	Lin. coverage	Depth 32.48 lin. ft	9.90 lin. m
	per row	Length 7.22 lin. ft	2.20 lin. m

## 450 x 150

Specifications per pallet		Imperial	Metric
 98 units / pallet	Product dimension (L x W x H)	17 <sup>1</sup> / <sub>16</sub> x 5 <sup>7</sup> / <sub>8</sub> x 3 <sup>15</sup> / <sub>16</sub>	450 x 150 x 100
	Cubing	71.20 ft <sup>2</sup>	6.62 m <sup>2</sup>
	Approx. Weight	3 357 lbs	1 523 kg
	Number of rows	7	
	Coverage per row	10.17 ft <sup>2</sup>	0.95 m <sup>2</sup>
	Lin. coverage	Depth 20.67 lin. ft	6.30 lin. m
	per row	Length 6.89 lin. ft	2.10 lin. m

## 450 x 300

Specifications per pallet		Imperial	Metric
 42 units / pallet	Product dimension (L x W x H)	17 <sup>1</sup> / <sub>16</sub> x 11 <sup>1</sup> / <sub>8</sub> x 3 <sup>15</sup> / <sub>16</sub>	450 x 300 x 100
	Cubing	61.03 ft <sup>2</sup>	5.67 m <sup>2</sup>
	Approx. Weight	2 883 lbs	1 308 kg
	Number of rows	7	
	Coverage per row	8.72 ft <sup>2</sup>	0.81 m <sup>2</sup>
	Lin. coverage	Depth 8.86 lin. ft	2.70 lin. m
	per row	Length 5.91 lin. ft	1.80 lin. m

### Laying Patterns Options

11 | Linear

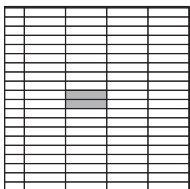

Patterns are for design inspiration only. The installer is responsible to calculate & purchase the correct amount of material.

### NOTES

See page 6 for icons description.

See page 27 for more information about applications.

See page 62 to 64 for more technical information.

Please note that for barefoot walking areas (e.g. pool deck) dark-colored paving units could get very hot under the sun.

### Pallet Overview - 450 x 100

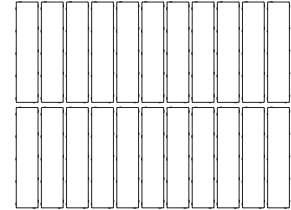

### Pallet Overview - 450 x 150

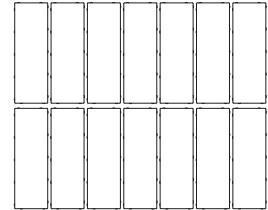

### Pallet Overview - 450 x 300

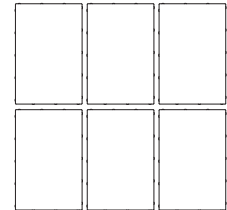

See page 22 for list of In-Stock or On order colors for all items of Industria Collection.

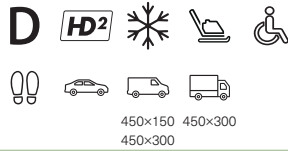

# INDUSTRIA 450 Series

DESCRIPTION: Paver TEXTURE: HD² Polished

## Pallet Overview - 450 x 100

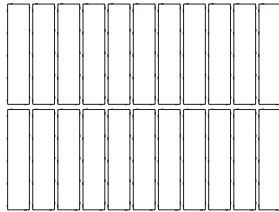

## Pallet Overview - 450 x 150

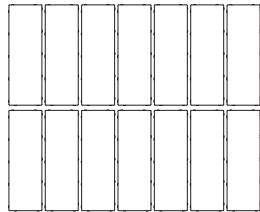

## Pallet Overview - 450 x 300

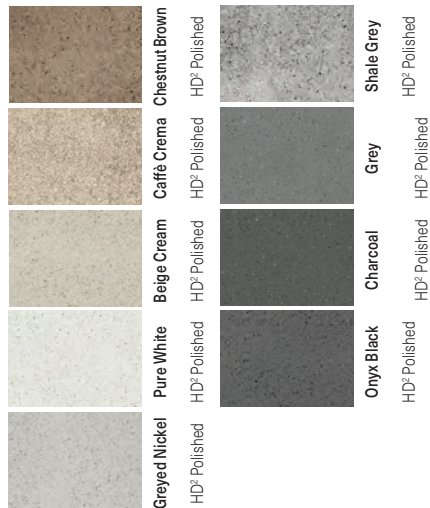
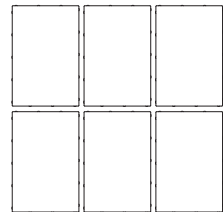

### 450 x 100

#### Specifications per pallet



154 units / pallet

		Imperial	Metric
Product dimension (L x W x H)		17 1/16 x 3 15/16 x 3 3/4	450 x 100 x 95
Cubing		74.59 ft²	6.93 m²
Approx. Weight		3 516 lbs	1 595 kg
Number of rows		7	
Coverage per row		10.66 ft²	0.99 m²
Lin. coverage per row	Depth	32.48 lin. ft	9.90 lin. m
	Length	7.22 lin. ft	2.20 lin. m

### 450 x 150

#### Specifications per pallet



98 units / pallet

		Imperial	Metric
Product dimension (L x W x H)		17 1/16 x 5 7/8 x 3 3/4	450 x 150 x 95
Cubing		71.20 ft²	6.62 m²
Approx. Weight		3 357 lbs	1 523 kg
Number of rows		7	
Coverage per row		10.17 ft²	0.95 m²
Lin. coverage per row	Depth	20.67 lin. ft	6.30 lin. m
	Length	6.89 lin. ft	2.10 lin. m

### 450 x 300

#### Specifications per pallet



42 units / pallet

		Imperial	Metric
Product dimension (L x W x H)		17 1/16 x 11 13/16 x 3 3/4	450 x 300 x 95
Cubing		61.03 ft²	5.67 m²
Approx. Weight		2 883 lbs	1 308 kg
Number of rows		7	
Coverage per row		8.72 ft²	0.81 m²
Lin. coverage per row	Depth	8.86 lin. ft	2.70 lin. m
	Length	5.91 lin. ft	1.80 lin. m

## Laying Patterns Options

13 | Herringbone

14 | Herringbone

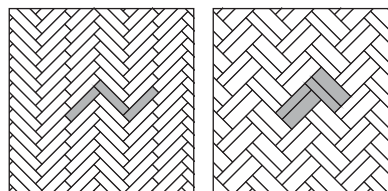

Patterns are for design inspiration only. The installer is responsible to calculate & purchase the correct amount of material.

## NOTES

See page 6 for icons description.

See page 27 for more information about applications.

See page 62 to 64 for more technical information.

Please note that for barefoot walking areas (e.g. pool deck) dark-colored paving units could get very hot under the sun.

See page 22 for list of In-Stock or On order colors for all items of Industria Collection.



# INDUSTRIA 600 Series

DESCRIPTION: Paver TEXTURE: HD<sup>2</sup> Smooth or HD<sup>2</sup> Granitex



600×200 600×200  
600×300 600×300

## 600 × 100

### Specifications per pallet

	Imperial	Metric
 Product dimension (L × W × H)	23 5/8 × 3 15/16 × 3 15/16	600 × 100 × 100
Cubing	45.21 ft <sup>2</sup>	4.20 m <sup>2</sup>
Approx. Weight	2 112 lbs	958 kg
Number of rows	7	
Coverage per row	6.46 ft <sup>2</sup>	0.60 m <sup>2</sup>
Lin. coverage per row	Depth 19.69 lin. ft Length 3.28 lin. ft	6 lin. m 1 lin. m

70 units / pallet

## 600 × 200

### Specifications per pallet

	Imperial	Metric
 Product dimension (L × W × H)	23 5/8 × 7 7/8 × 3 15/16	600 × 200 × 100
Cubing	45.21 ft <sup>2</sup>	4.20 m <sup>2</sup>
Approx. Weight	2 146 lbs	973 kg
Number of rows	7	
Coverage per row	6.46 ft <sup>2</sup>	0.60 m <sup>2</sup>
Lin. coverage per row	Depth 9.84 lin. ft Length 3.28 lin. ft	3 lin. m 1 lin. m

35 units / pallet

## 600 × 300

### Specifications per pallet

	Imperial	Metric
 Product dimension (L × W × H)	23 5/8 × 11 15/16 × 3 15/16	600 × 300 × 100
Cubing	54.25 ft <sup>2</sup>	5.04 m <sup>2</sup>
Approx. Weight	2 567 lbs	1 164 kg
Number of rows	7	
Coverage per row	7.75 ft <sup>2</sup>	0.72 m <sup>2</sup>
Lin. coverage per row	Depth 7.87 lin. ft Length 3.94 lin. ft	2.40 lin. m 1.20 lin. m

28 units / pallet

### Pallet Overview - 600 × 100

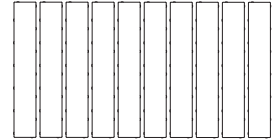

### Pallet Overview - 600 × 200

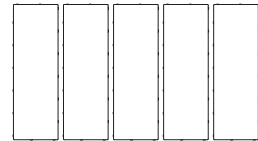

### Pallet Overview - 600 × 300

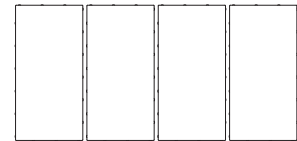

## Laying Patterns Options

25 | Linear

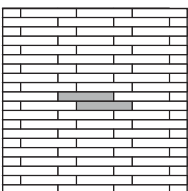

Patterns are for design inspiration only. The installer is responsible to calculate & purchase the correct amount of material.

## NOTES

See page 6 for icons description.

See page 27 for more information about applications.

See page 62 to 64 for more technical information.

Please note that for barefoot walking areas (e.g. pool deck) dark-colored paving units could get very hot under the sun.



See page 22 for list of In-Stock or On order colors for all items of Industria Collection.

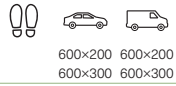

# INDUSTRIA 600 Series

DESCRIPTION: Paver TEXTURE: HD² Polished

## Pallet Overview - 600 × 100

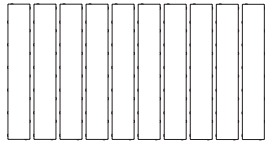

## Pallet Overview - 600 × 200

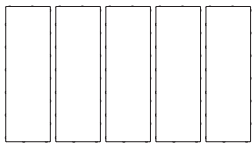

## Pallet Overview - 600 × 300

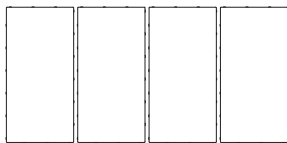

See page 22 for list of In-Stock or On order colors for all items of Industria Collection.

## 600 × 100

Specifications per pallet		Imperial	Metric
 70 units / pallet	Product dimension (L × W × H)	23 5/8 × 3 15/16 × 3 3/4	600 × 100 × 95
	Cubing	45.21 ft²	4.20 m²
	Approx. Weight	2 112 lbs	958 kg
	Number of rows	7	
Coverage per row		6.46 ft²	0.60 m²
Lin. coverage per row	Depth	19.69 lin. ft	6 lin. m
	Length	3.28 lin. ft	1 lin. m

## 600 × 200

Specifications per pallet		Imperial	Metric
 35 units / pallet	Product dimension (L × W × H)	23 5/8 × 7 7/8 × 3 3/4	600 × 200 × 95
	Cubing	45.21 ft²	4.20 m²
	Approx. Weight	2 145 lbs	973 kg
	Number of rows	7	
Coverage per row		6.46 ft²	0.60 m²
Lin. coverage per row	Depth	9.84 lin. ft	3 lin. m
	Length	3.28 lin. ft	1 lin. m

## 600 × 300

Specifications per pallet		Imperial	Metric
 28 units / pallet	Product dimension (L × W × H)	23 5/8 × 11 15/16 × 3 3/4	600 × 300 × 95
	Cubing	54.25 ft²	5.04 m²
	Approx. Weight	2 567 lbs	1 164 kg
	Number of rows	7	
Coverage per row		7.75 ft²	0.72 m²
Lin. coverage per row	Depth	7.87 lin. ft	2.40 lin. m
	Length	3.94 lin. ft	1.20 lin. m

## Laying Patterns Options

27 | Linear      28 | Linear

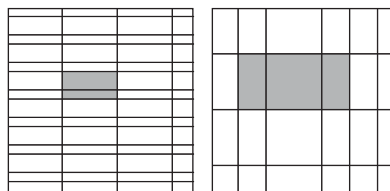

Patterns are for design inspiration only. The installer is responsible to calculate & purchase the correct amount of material.

## NOTES

See page 6 for icons description.  
See page 27 for more information about applications.  
See page 62 to 64 for more technical information.

Please note that for barefoot walking areas (e.g. pool deck) dark-colored paving units could get very hot under the sun.



# INDUSTRIA 600 Series

DESCRIPTION: Paver TEXTURE: HD<sup>2</sup> Smooth or HD<sup>2</sup> Granitex



600 x 600

### Specifications per pallet



14 units / pallet

	Imperial	Metric
Product dimension (L x W x H)	23 5/8 x 23 5/8 x 3 15/16	600 x 600 x 100
Cubing	54.25 ft <sup>3</sup>	5.04 m <sup>3</sup>
Approx. Weight	2 556 lbs	1 159 kg
Number of rows	7	
Coverage per row	7.75 ft <sup>2</sup>	0.72 m <sup>2</sup>
Lin. coverage per row	3.94 lin. ft	1.20 lin. m

### Pallet Overview - 600 x 600



### Laying Patterns Options

29 | Linear

30 | Linear

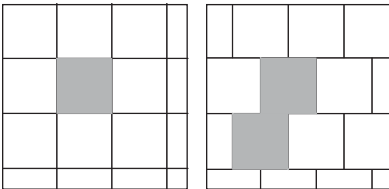

Patterns are for design inspiration only. The installer is responsible to calculate & purchase the correct amount of material.

### NOTES

See page 6 for icons description.

See page 27 for more information about applications.

See page 62 to 64 for more technical information.

Please note that for barefoot walking areas (e.g. pool deck) dark-colored paving units could get very hot under the sun.



See page 22 for list of In-Stock or On order colors for all items of Industria Collection.



# INDUSTRIA 600 Series

DESCRIPTION: Paver TEXTURE: HD² Polished

## Pallet Overview - 600 × 600



600 × 600

### Specifications per pallet



14 units / pallet

	Imperial	Metric
Product dimension (L × W × H)	23 5/8 × 23 5/8 × 3 3/4	600 × 600 × 95
Cubing	54.25 ft²	5.04 m²
Approx. Weight	2 556 lbs	1 159 kg
Number of rows	7	
Coverage per row	7.75 ft²	0.72 m²
Lin. coverage per row	3.94 lin. ft	1.20 lin. m



## Laying Patterns Options

29 | Linear

30 | Linear

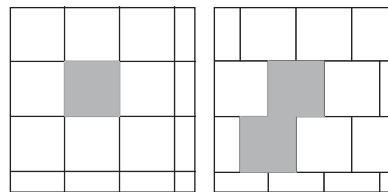

Patterns are for design inspiration only. The installer is responsible to calculate & purchase the correct amount of material.

## NOTES

See page 6 for icons description.  
See page 27 for more information about applications.  
See page 62 to 64 for more technical information.

Please note that for barefoot walking areas (e.g. pool deck) dark-colored paving units could get very hot under the sun.

See page 22 for list of In-Stock or On order colors for all items of Industria Collection.



# INDUSTRIA 900 Series

DESCRIPTION: Paver TEXTURE: HD² Smooth or HD² Granitex

900 × 300			
Specifications per pallet		Imperial	Metric
 28 units / pallet	Product dimension (L × W × H)	35 <sup>7</sup> / <sub>16</sub> × 11 <sup>13</sup> / <sub>16</sub> × 3 <sup>15</sup> / <sub>16</sub>	900 × 300 × 100
	Cubing	81.38 ft²	7.56 m²
	Approx. Weight	3 821 lbs	1 733 kg
	Number of rows	7	
	Coverage per row	11.63 ft²	1.08 m²

900 × 600			
Specifications per pallet		Imperial	Metric
 14 units / pallet	Product dimension (L × W × H)	35 <sup>7</sup> / <sub>16</sub> × 23 <sup>5</sup> / <sub>16</sub> × 3 <sup>15</sup> / <sub>16</sub>	900 × 600 × 100
	Cubing	81.38 ft²	7.56 m²
	Approx. Weight	3 839 lbs	1 741 kg
	Number of rows	7	
	Coverage per row	11.63 ft²	1.08 m²

900 × 900			
Specifications per pallet		Imperial	Metric
 7 units / pallet	Product dimension (L × W × H)	35 <sup>7</sup> / <sub>16</sub> × 35 <sup>7</sup> / <sub>16</sub> × 3 <sup>15</sup> / <sub>16</sub>	900 × 900 × 100
	Cubing	61.00 ft²	5.67 m²
	Approx. Weight	2 893 lbs	1 312 kg
	Number of rows	7	
	Coverage per row	8.72 ft²	0.81 m²

## Laying Patterns Options

31 | Linear

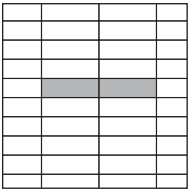

Patterns are for design inspiration only. The installer is responsible to calculate & purchase the correct amount of material.

## NOTES

See page 6 for icons description.

See page 27 for more information about applications.

See page 62 to 64 for more technical information.

Please note that for barefoot walking areas (e.g. pool deck) dark-colored paving units could get very hot under the sun.

### Pallet Overview - 900 × 300

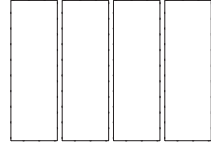

### Pallet Overview - 900 × 600



### Pallet Overview - 900 × 900

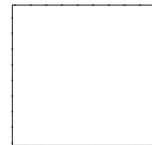

See page 22 for list of In-Stock or On order colors for all items of Industria Collection.



# INDUSTRIA 900 Series

DESCRIPTION: Paver TEXTURE: HD² Polished

## Pallet Overview - 900 x 300

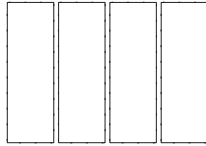

## Pallet Overview - 900 x 600

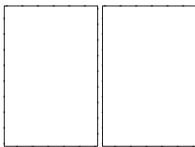

## Pallet Overview - 900 x 900

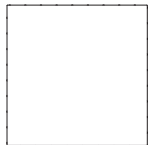

See page 22 for list of In-Stock or On order colors for all items of Industria Collection.

### 900 x 300

#### Specifications per pallet



28 units / pallet

	Imperial	Metric
Product dimension (L x W x H)	35 7/16 x 11 13/16 x 3 3/4	900 x 300 x 95
Cubing	81.38 ft²	7.56 m²
Approx. Weight	3 821 lbs	1 733 kg
Number of rows	7	
Coverage per row	11.63 ft²	1.08 m²

### 900 x 600

#### Specifications per pallet



14 units / pallet

	Imperial	Metric
Product dimension (L x W x H)	35 7/16 x 23 5/16 x 3 3/4	900 x 600 x 95
Cubing	81.38 ft²	7.56 m²
Approx. Weight	3 839 lbs	1 741 kg
Number of rows	7	
Coverage per row	11.63 ft²	1.08 m²

### 900 x 900

#### Specifications per pallet



7 units / pallet

	Imperial	Metric
Product dimension (L x W x H)	35 7/16 x 35 7/16 x 3 3/4	900 x 900 x 95
Cubing	61.00 ft²	5.67 m²
Approx. Weight	2 893 lbs	1 312 kg
Number of rows	7	
Coverage per row	8.72 ft²	0.81 m²

## Laying Patterns Options

42 | Linear

44 | Herringbone

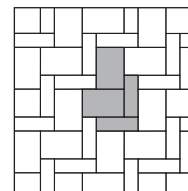
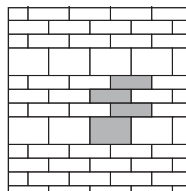

Patterns are for design inspiration only. The installer is responsible to calculate & purchase the correct amount of material.

## NOTES

See page 6 for icons description.

See page 27 for more information about applications.

See page 62 to 64 for more technical information.



Please note that for barefoot walking areas (e.g. pool deck) dark-colored paving units could get very hot under the sun.



# LINEA Small rectangles

DESCRIPTION: Paver TEXTURE: Smooth



Specifications per pallet		Imperial	Metric
<b>A</b>	 77 units / pallet	Product dimension (L×W×H) <b>A</b> 8 7/8 × 3 15/16 × 3 15/16	225 × 100 × 100
<b>B</b>	 77 units / pallet	Product dimension (L×W×H) <b>B</b> 12 13/16 × 3 15/16 × 3 15/16	325 × 100 × 100
<b>C</b>	 77 units / pallet	Product dimension (L×W×H) <b>C</b> 16 3/4 × 3 15/16 × 3 15/16	425 × 100 × 100
		Cubing	80.81 ft <sup>2</sup> / 7.51 m <sup>2</sup>
		Approx. Weight	3 634 lbs / 1 648 kg
		Number of rows	7
		Coverage per row	11.54 ft <sup>2</sup> / 1.07 m <sup>2</sup>
		Lin. coverage per row	35.25 lin. ft / 10.74 lin. m

## Pallet Overview

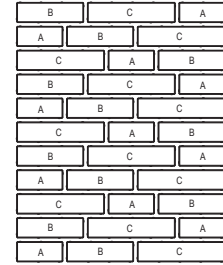

Chestnut Brown  
Champlain Grey  
Shale Grey  
Onyx Black

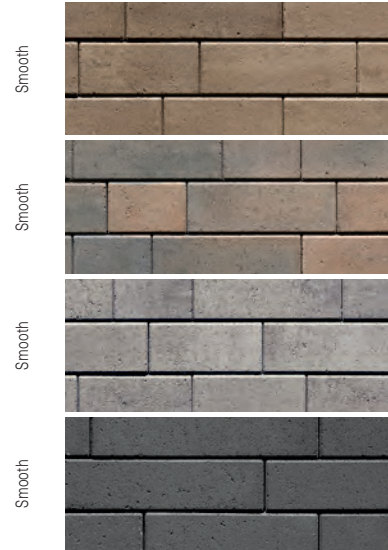

## Laying Patterns Options

01 | Linear

03 | Linear

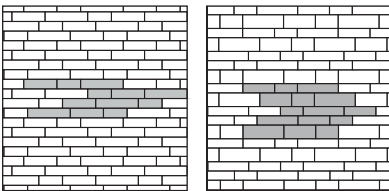

Patterns are for design inspiration only. The installer is responsible to calculate & purchase the correct amount of material.

## NOTES

See page 6 for icons description.

See page 27 for more information about applications.

See page 62 to 64 for more technical information.

Please note that for barefoot walking areas (e.g. pool deck) dark-colored paving units could get very hot under the sun.



# LINEA Large rectangles

DESCRIPTION: Paver TEXTURE: Smooth

## Pallet Overview

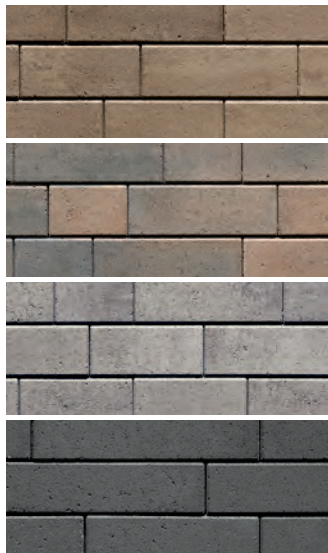
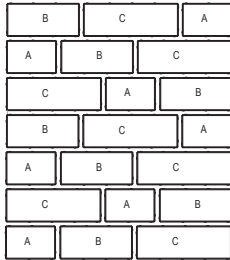

Smooth Chestnut Brown  
Smooth Champlain Grey  
Smooth Shale Grey  
Smooth Onyx Black

## Specifications per pallet

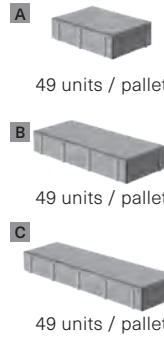

	Imperial	Metric
Product dimension (L x W x H) <b>A</b>	8 7/8 x 5 7/8 x 3 15/16	225 x 150 x 100
Product dimension (L x W x H) <b>B</b>	12 3/16 x 5 7/8 x 3 15/16	325 x 150 x 100
Product dimension (L x W x H) <b>C</b>	16 3/4 x 5 7/8 x 3 15/16	425 x 150 x 100
Cubing	77.14 ft <sup>2</sup>	7.17 m <sup>2</sup>
Approx. Weight	3 561 lbs	1 615 kg
Number of rows	7	
Coverage per row	11.02 ft <sup>2</sup>	1.02 m <sup>2</sup>
Lin. coverage per row	22.40 lin. ft	6.83 lin. m

## Laying Patterns Options

01 | Linear      03 | Linear

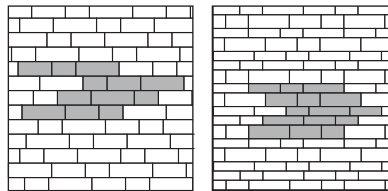

Patterns are for design inspiration only. The installer is responsible to calculate & purchase the correct amount of material.

## NOTES



See page 6 for icons description.  
See page 27 for more information about applications.  
See page 62 to 64 for more technical information.

Please note that for barefoot walking areas (e.g. pool deck) dark-colored paving units could get very hot under the sun.



# MISTA Random

**DESCRIPTION:** Paver **TEXTURE:** Multi-textured

Specifications per pallet	Imperial	Metric
<b>A</b>  Product dimension (L×W×H) <b>A</b>	3 15/16 × 7 7/8 × 2 9/16	100 × 200 × 65
80 units / pallet	<b>B</b> Product dimension (L×W×H) <b>B</b>	7 7/8 × 7 7/8 × 2 9/16
<b>B</b>  Product dimension (L×W×H) <b>C</b>	11 13/16 × 7 7/8 × 2 9/16	300 × 200 × 65
100 units / pallet	Cubing	116.20 ft <sup>2</sup>
<b>C</b>  Approx. Weight	3 356 lbs	1 522 kg
90 units / pallet	Number of rows	10
Coverage per row	11.62 ft <sup>2</sup>	1.08 m <sup>2</sup>
Lin. coverage per row	17.71 lin. ft	5.40 lin. m

## Pallet Overview

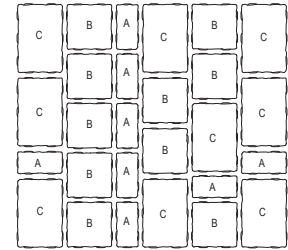

**Chestnut Brown** Multi-textured  
**Sandlewood** Multi-textured  
**Champlain Grey** Multi-textured  
**Shale Grey** Multi-textured



## Laying Patterns Options

04 | Modular

05 | Modular

06 | Linear

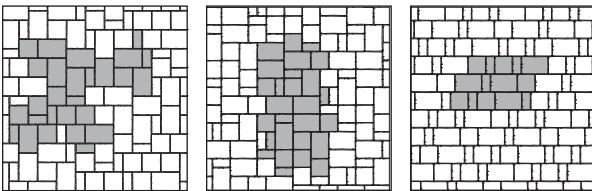

Patterns are for design inspiration only. The installer is responsible to calculate & purchase the correct amount of material.

## NOTES

See page 6 for icons description.

See page 27 for more information about applications.

See page 62 to 64 for more technical information. When used in a permeable pavement application, see page 100 to 105 for more technical information.

**JOINT WIDTH:** 3/16" to 9/16" (4 to 14 mm)

**% OF SURFACE OPENING:** 6.3 %

**INFILTRATION RATE:** 610 in./hr (15 505 mm/hr)

Permeable pavers allow for storm water drainage and manage excess runoff. The use of permeable pavers also facilitates LEED® certification easier to obtain.

Please note that for barefoot walking areas (e.g. pool deck) dark-colored paving units could get very hot under the sun.



# SLEEK

DESCRIPTION: Paver TEXTURE: HD² Smooth

## Pallet Overview

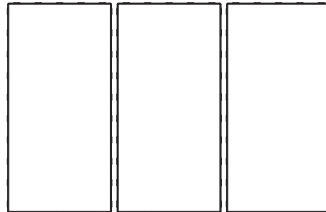

## Specifications per pallet



24 units / pallet

	Imperial	Metric
Product dimension (L x W x H)	31 15/16 x 15 7/8 x 3 9/16	811 x 404 x 90
Cubing	84.59 ft²	7.86 m²
Approx. Weight	3 543 lbs	1 607 kg
Number of rows	8	
Coverage per unit	10.57 ft²	0.98 m²
Lin. coverage per row	Depth	7.98 lin. ft
	Length	3.98 lin. ft

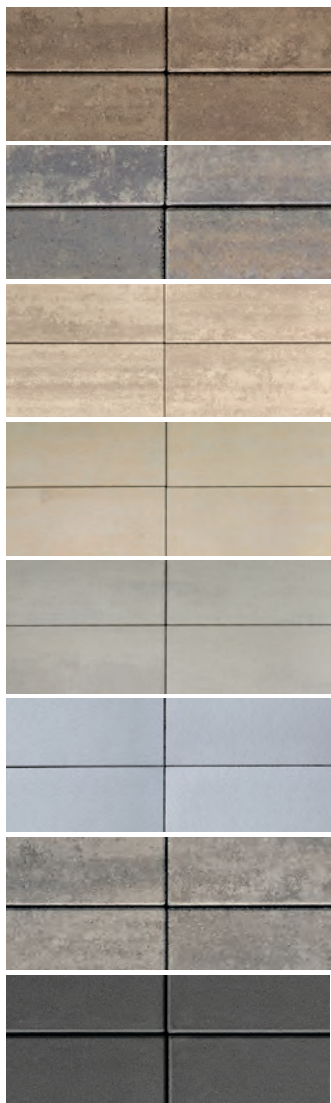

- HD² Smooth Chestnut Brown
- HD² Smooth Champlain Grey
- HD² Smooth Caffé Crema
- HD² Smooth Beige Cream
- HD² Smooth Greyed Nickel
- HD² Smooth Silver Granite
- HD² Smooth Shale Grey
- HD² Smooth Onyx Black

## Laying Patterns Options

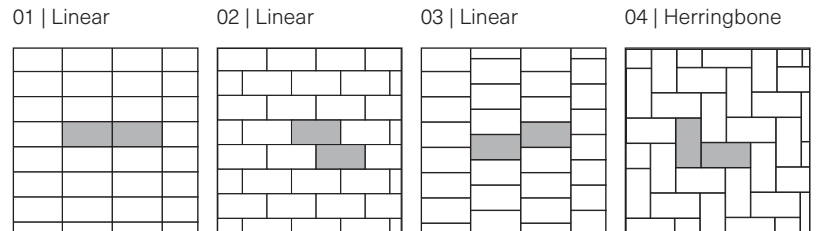

Patterns are for design inspiration only. The installer is responsible to calculate & purchase the correct amount of material.

## NOTES

See page 6 for icons description.  
 See page 27 for more information about applications.  
 See page 62 to 64 for more technical information.

Please note that for barefoot walking areas (e.g. pool deck) dark-colored paving units could get very hot under the sun.



# SQUADRA

DESCRIPTION: Paver TEXTURE: Slate



Specifications per pallet	Imperial	Metric
 Product dimension (L×W×H)	3 ¼ × 3 ¼ × 2 ¾	83 × 83 × 60
Cubing	73.41 ft <sup>2</sup>	6.82 m <sup>2</sup>
990 units / pallet	Approx. Weight	1 892 lbs / 858 kg
	Number of rows	9
	Coverage per row	8.16 ft <sup>2</sup> / 0.76 m <sup>2</sup>
	Lin. coverage per row	29.95 lin. ft / 9.13 lin. m

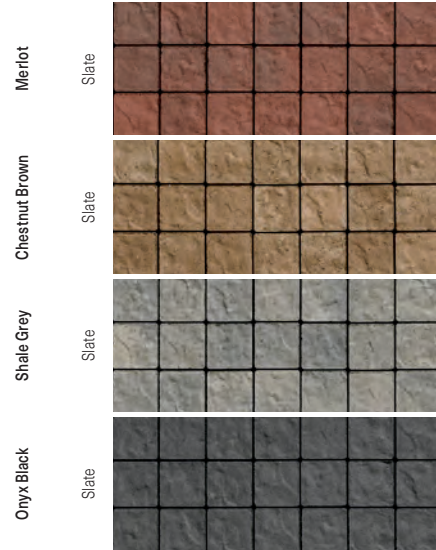
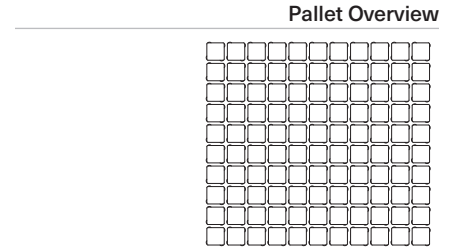

## Laying Patterns Options

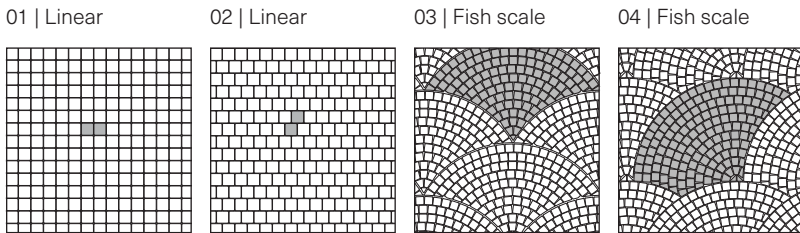

Patterns are for design inspiration only. The installer is responsible to calculate & purchase the correct amount of material.

## NOTES

See page 6 for icons description.  
 See page 27 for more information about applications.  
 See page 62 to 64 for more technical information.

Please note that for barefoot walking areas (e.g. pool deck) dark-colored paving units could get very hot under the sun.



# TERRAZZO

**DESCRIPTION:** Paver **TEXTURE:** Polished

## Pallet Overview - 300 x 150

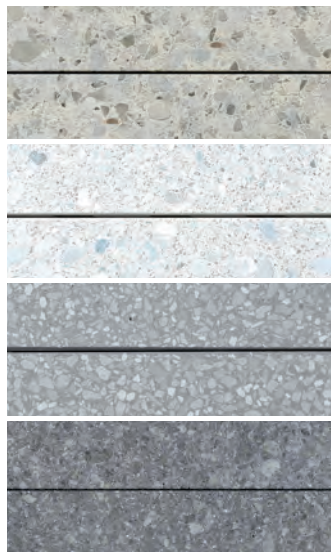
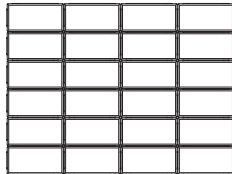

Polished **Stardust Beige**  
 Polished **Mineral White**  
 Polished **Moonrock Grey**  
 Polished **Meteor Black**

## Specifications per pallet



216 units / pallet

		Imperial	Metric
Product dimension (L x W x H)		11 13/16 x 5 7/8 x 2 3/8	300 x 150 x 60
Cubing		104.63 ft <sup>2</sup>	9.72 m <sup>2</sup>
Approx. Weight		3 037 lbs	1 377 kg
Number of rows		9	
Coverage per row		11.63 ft <sup>2</sup>	1.08 m <sup>2</sup>
Lin. coverage per row	Depth	11.81 lin. ft	3.60 lin. m
	Length	23.63 lin. ft	7.20 lin. m

## Laying Patterns Options

01 | Linear

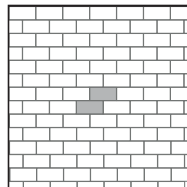

04 | Stack Bond

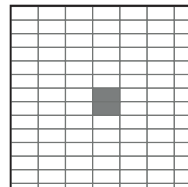

05 | Herringbone

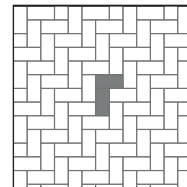

06 | Herringbone

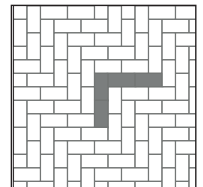

Patterns are for design inspiration only. The installer is responsible to calculate & purchase the correct amount of material.

## NOTES

See page 6 for icons description.

See page 27 for more information about applications.

See page 34 to 36 for more technical information.

Every unit is calibrated to ensure height is within a 1 mm tolerance.

\*The Terrazzo Collection comes with a factory-applied, water-based "natural look" protectant that enhances the surface and aids in maintenance. However, to maintain its de-icing salt resistant properties, it is essential to re-apply a concrete or natural stone water-based protectant or sealer periodically.

We recommend applying the protectant as soon as you observe water absorption. If water is still repelled, re-application is not yet necessary. Always test the

protectant or sealer on a small, hidden area before full application.

Please note that for barefoot walking areas (e.g. pool deck) dark-colored paving units could get very hot under the sun.



# VALET

DESCRIPTION: Paver TEXTURE: Basalt



Specifications per pallet	Imperial	Metric
 Product dimension (L x W x H)	6 1/2 x 6 1/2 x 2 3/8	165 x 165 x 60
Cubing	92.31 ft <sup>2</sup>	8.58 m <sup>2</sup>
315 units / pallet	Approx. Weight	2 381 lbs / 1 080 kg
	Number of rows	9
	Coverage per unit	10.26 ft <sup>2</sup> / 0.95 m <sup>2</sup>
	Lin. coverage per row	18.95 lin. ft / 5.78 lin. m

## Pallet Overview

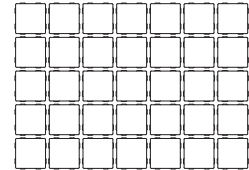

## Laying Patterns Options

01 | Checkerboard

02 | Linear

03 | Linear

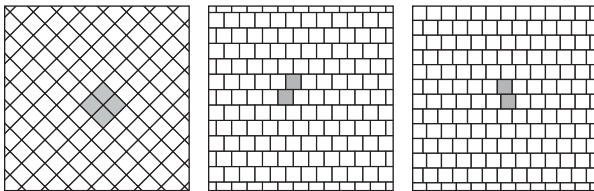

Patterns are for design inspiration only. The installer is responsible to calculate & purchase the correct amount of material.

## NOTES

See page 6 for icons description.

See page 27 for more information about applications.

See page 62 to 64 for more technical information. When used in a permeable pavement application, see page 100 to 106 for more technical information.

**JOINT WIDTH:** 3/16" (7 mm)  
**% OF SURFACE OPENING:** 5.9 %  
**INFILTRATION RATE:** 400 in./hr (10 160 mm/hr)

Please note that for barefoot walking areas (e.g. pool deck) dark-colored paving units could get very hot under the sun.

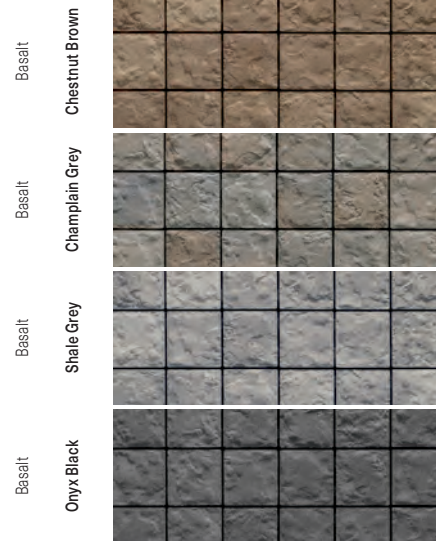



# VICTORIEN 60 mm

DESCRIPTION: Paver TEXTURE: Smooth

### Pallet Overview

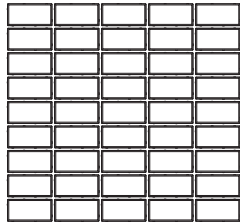

### Specifications per pallet



495 units / pallet

		Imperial	Metric
Product dimension (L x W x H)		8 1/2 x 4 1/4 x 2 3/8	216 x 108 x 60
Cubing		123.70 ft <sup>2</sup>	11.50 m <sup>2</sup>
Approx. Weight		3 481 lbs	1 579 kg
Number of rows		11	
Coverage per unit		11.25 ft <sup>2</sup>	1.05 m <sup>2</sup>
Lin. coverage per row	Depth	15.87 lin. ft	4.84 lin. m
	Length	31.74 lin. ft	9.68 lin. m



Shale Grey  
Smooth

Onyx Black  
Smooth

### Laying Patterns Options

01 | Linear

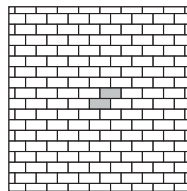

02 | Linear

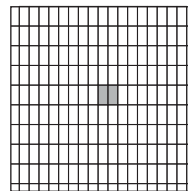

05 | Parquet

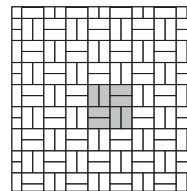

06 | Herringbone

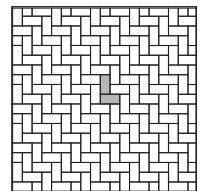

07 | Herringbone

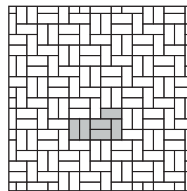

Patterns are for design inspiration only. The installer is responsible to calculate & purchase the correct amount of material.

### NOTES

See page 6 for icons description.

See page 27 for more information about applications.

See page 62 to 64 for more technical information.





Please note that for barefoot walking areas (e.g. pool deck) dark-colored paving units could get very hot under the sun.



# VILLAGIO

DESCRIPTION: Paver TEXTURE: Beveled



Specifications per pallet		Imperial	Metric
<b>A</b>	 Product dimension (L×W×H) <b>A</b>	5 1/8 × 5 1/8 × 2 3/8	130 × 130 × 60
	Product dimension (L×W×H) <b>B</b>	6 5/16 × 5 1/8 × 2 3/8	160 × 130 × 60
	Product dimension (L×W×H) <b>C</b>	7 5/16 × 5 1/8 × 2 3/8	185 × 130 × 60
<b>B</b>	 Product dimension (L×W×H) <b>D</b>	8 7/16 × 5 1/8 × 2 3/8	215 × 130 × 60
	Cubing	117 ft <sup>2</sup>	10.88 m <sup>2</sup>
	Approx. Weight	2 960 lbs	1 342 kg
<b>C</b>	 Number of rows	11	
	Coverage per row	10.64 ft <sup>2</sup>	0.99 m <sup>2</sup>
<b>D</b>	 Lin. coverage per row	24.94 lin. ft	7.61 lin. m

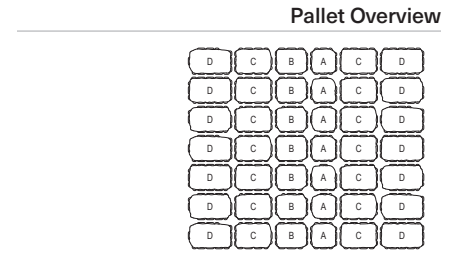

## Laying Patterns Options

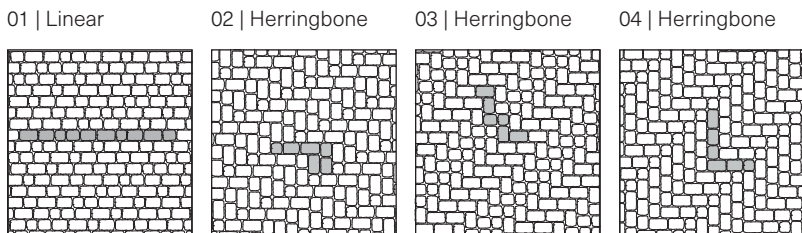

Patterns are for design inspiration only. The installer is responsible to calculate & purchase the correct amount of material.

## NOTES

See page 6 for icons description.  
 See page 27 for more information about applications.  
 See page 62 to 64 for more technical information. When used in a permeable pavement application, see page 100 to 105 for more technical information.

**JOINT WIDTH:** 3/8" to 9/16" (9 to 15 mm)  
**% OF SURFACE OPENING:** 8.0 %  
**INFILTRATION RATE:** 896 in./hr (22 750 mm/hr)

The Villagio paver allows for gentle curves and winding pathways, eliminating the need for cuts.

Please note that for barefoot walking areas (e.g. pool deck) dark-colored paving units could get very hot under the sun.

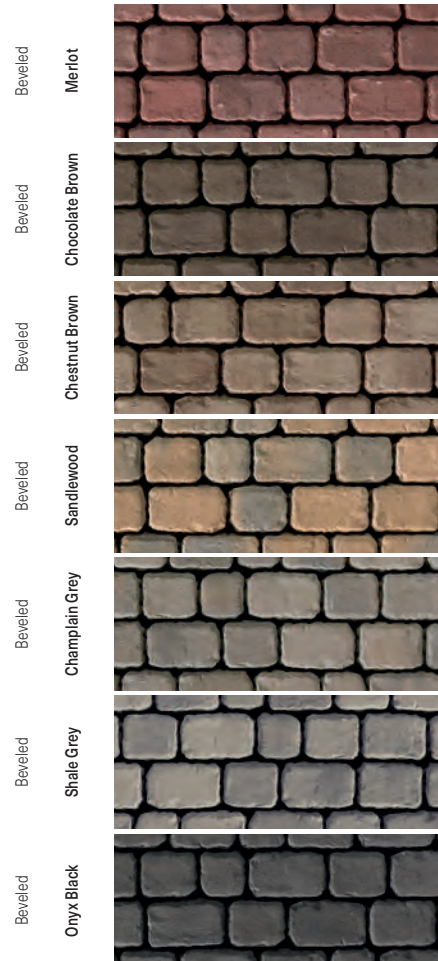

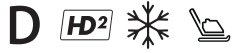

# WESTMOUNT

**DESCRIPTION:** Paver **TEXTURE:** HD<sup>2</sup> Smooth

## Pallet Overview

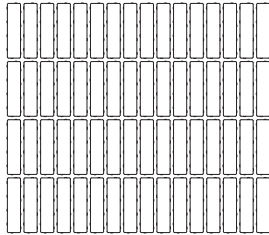

## Specifications per pallet



		Imperial	Metric
Product dimension (L x W x H)		9 7/16 x 2 3/8 x 3 1/8	240 x 60 x 80
Cubing		79.36 ft <sup>2</sup>	7.37 m <sup>2</sup>
Approx. Weight		2 952 lbs	1 339 kg
Number of rows		8	
Coverage per row		9.92 ft <sup>2</sup>	0.92 m <sup>2</sup>
Lin. coverage per row	Depth	12.60 lin. ft	3.84 lin. m
	Length	50.39 lin. ft	15.36 lin. m



**Merlot**  
HD<sup>2</sup> Smooth



**Chestnut Brown**  
HD<sup>2</sup> Smooth



**Caffé Crema**  
HD<sup>2</sup> Smooth



**Shale Grey**  
HD<sup>2</sup> Smooth

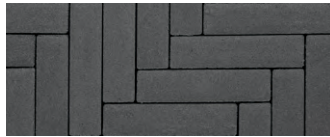

**Onyx Black**  
HD<sup>2</sup> Smooth

## Laying Patterns Options

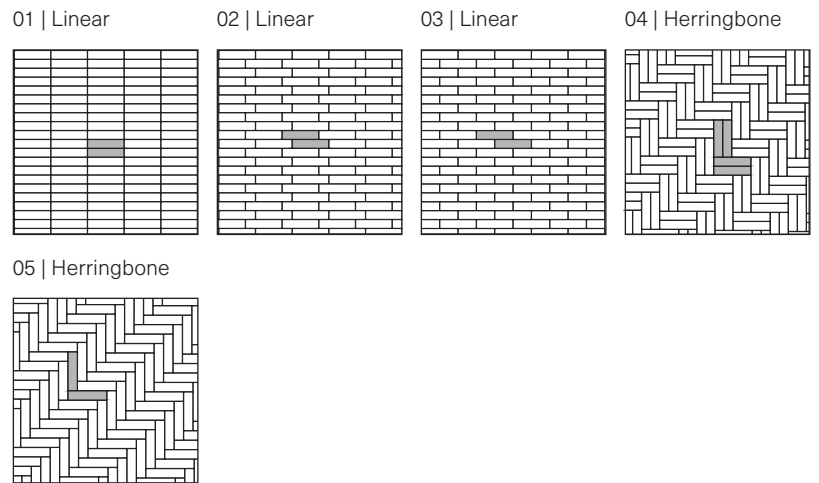

Patterns are for design inspiration only. The installer is responsible to calculate & purchase the correct amount of material.

## NOTES

See page 27 for more information about applications.

See page 6 for icons description.

Please note that for barefoot walking areas (e.g. pool deck) dark-colored paving units could get very hot under the sun.

# PERMEABLE



Aquastorm	P. 106
Hydra	P. 107
Mika	P. 108
Pure	P. 109
Saint-Oxford	P. 110

## PHYSICAL AND GEOMETRICAL CHARACTERISTICS

CHARACTERISTICS	ASTM C936	CSA A231.2:19
Compressive strength	8000 psi [55 MPa] min.	50 MPa min.
Absorption	5 % max.	
Freeze-thaw durability	Mass loss (max.): 225 g/m <sup>2</sup> at 28 cycles, or Mass loss (max.): 500 g/m <sup>2</sup> at 49 cycles	Mass loss (max.): 225 g/m <sup>2</sup> after 28 cycles, or Mass loss (max.): 500 g/m <sup>2</sup> after 49 cycles
Dimensional tolerances (see Notes below):	Length and Width: ± 0.063 in. [1.6 mm] Thickness: ± 0.125 in. [3.2 mm]	Length and Width: -1.0 mm to +2.0 mm Thickness: ± 3.0 mm

Notes: The dimensional tolerances shown above are prior to the application of architectural finishes.

## TOP 5 BENEFITS OF USING PERMEABLE PAVERS IN YOUR NEXT PROJECT



### PRESERVE NATURAL HYDROLOGY & REPLENISH GROUNDWATER

Maintain pre-development water flow patterns and support groundwater recharge by allowing rain to infiltrate naturally.



### IMPROVE STORMWATER MANAGEMENT

Reduce runoff volume and peak flow, easing pressure on municipal systems and lowering flood and erosion risks.



### ENHANCE WATER QUALITY

Filter out pollutants and contribute to cleaner water. Discharge to sewer is spread over a longer period.



### MITIGATE URBAN HEAT ISLANDS

Light-colored surfaces and evaporation of infiltrated rainwater help cool the air and reduce heat buildup in developed areas.



### LEED CERTIFICATION CREDITS

Contribute to sustainability goals and qualify for LEED certification by integrating permeable solutions.

## THE PERMEABLE COLLECTION: TESTED INFILTRATION RATES



If you see this icon, some or all of the products in that collection are permeable.

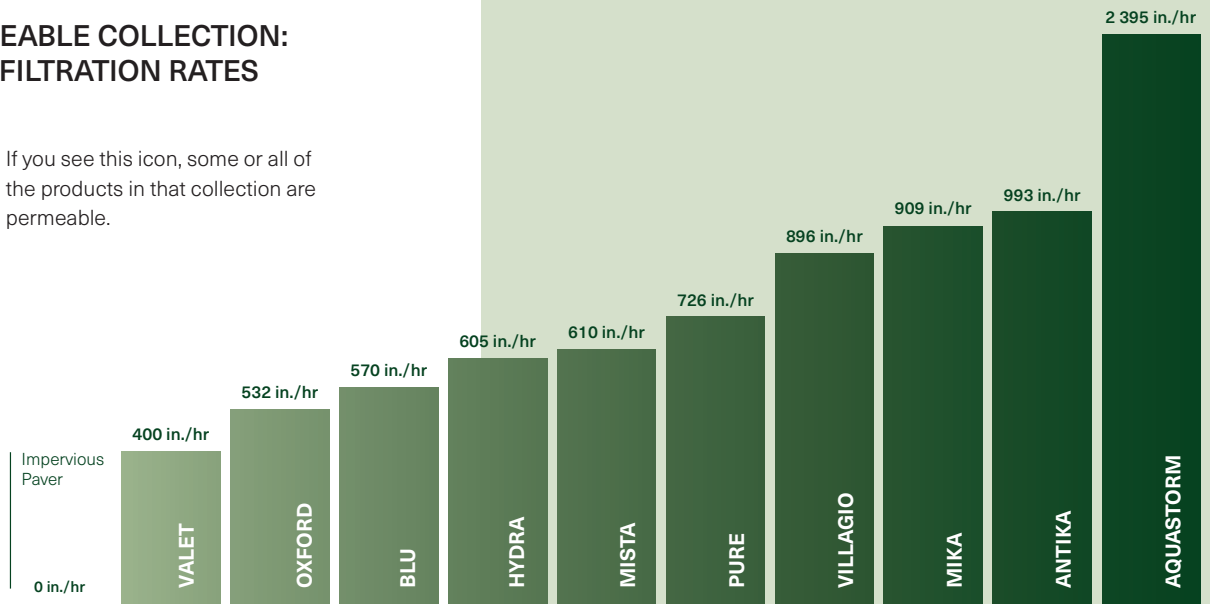

## DISCOVER THE LAYERS

Permeable pavers are only part of the story. Techo-Bloc systems are built from the ground up: engineered layers of aggregate, geotextile, and precision-placed pavers that maintain drainage performance year-round, even through harsh winters.

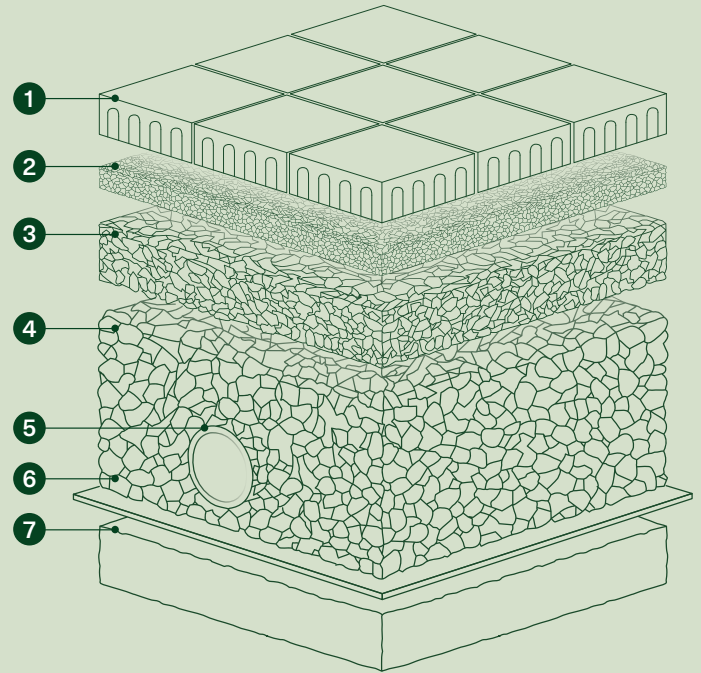

## CROSS SECTIONS

- 1. Permeable Paver**
- 2. Bedding Course Aggregate**  
ASTM no. 8, 89, or 9 (CSA 10-2.5 or 5-2.5) aggregate, or equivalent.
- 3. Base Course Aggregate**  
ASTM no. 57 (CSA 28-5) aggregate, or equivalent.
- 4. Subbase Course Aggregate**  
ASTM no. 2, 3 or 4 (CSA 80-40, 56-28 or 40-20) aggregate, or equivalent.
- 5. Perforated Pipe 4"**  
(100 mm) min. as required.
- 6. Geotextile**
- 7. Subgrade**

# INSTALLATION GUIDE

## SURFACE INFILTRATION CHARACTERISTICS

PERMEABLE PAVERS	PERCENT OF SURFACE OPENING (%)	JOINT WIDTH	INITIAL POST-CONSTRUCTION INFILTRATION RATE <sup>1</sup>
ANTIKA <sup>2</sup>	Variable	Variable	993 in./hr (25 227 mm/hr)
AQUASTORM <sup>2</sup>	38.4	1 5/8" (41mm)	2 395 in./hr (60 842 mm/hr)
BLU 60 mm (6x13) <sup>3</sup>	4.8	3/32" (7mm)	570 in./hr (14 475 mm/hr)
BLU 60 mm & BLU 60 (6x13) <sup>3</sup>	4.5	3/32" (7mm)	570 in./hr (14 475 mm/hr)
BLU 80 mm (6x13) <sup>3</sup>	4.8	3/32" (7mm)	570 in./hr (14 475 mm/hr)
BLU 80 mm & BLU 80 (6x13) <sup>3</sup>	4.5	3/32" (7mm)	570 in./hr (14 475 mm/hr)
HYDRA	8.3	1/2" (13mm)	605 in./hr (15 345 mm/hr)
MIKA <sup>2</sup>	7.8	5/8" (15mm)	909 in./hr (23 094 mm/hr)
MISTA random <sup>1</sup>	6.3	3/16" (4mm) to 9/16" (14mm)	610 in./hr (15 505 mm/hr)
OXFORD	7.3	3/8" (10mm)	532 in./hr (13 507 mm/h)
PURE <sup>2</sup>	5.0	3/8" (10mm)	726 in./hr (18 440 mm/hr)
TRAVERTINA RAW <sup>2</sup>	7.8	5/8" (15mm)	793 in./hr (20 150 mm/hr)
VALET <sup>2</sup>	5.9	3/32" (7mm)	400 in./hr (10 160 mm/hr)
VILLAGIO <sup>1</sup>	8.0	3/8" (9mm) to 9/16" (15mm)	896 in./hr (22 750 mm/hr)

<sup>1</sup> Measurements were taken at various sites in conformity to the standard ASTM C 1701-09

<sup>2</sup> Measurements were taken at various sites in conformity to the standard ASTM C 1781.

<sup>3</sup> A min. of 4.5% opening surface requires 75% of Blu 6x13 and 25% of Blu. Combinations with other products could be possible, contact your local representative for more information.

## OTHER PERMEABLE POSSIBILITIES



BLU 60 mm & BLU 60 mm (6x13) SLAB

(page 39 to 43)



AQUASTORM PAVER

(page 106)



ANTIKA PAVER

(page 65)



BLU 80 mm & BLU 80 mm (6x13) PAVER

(page 66 to 70)

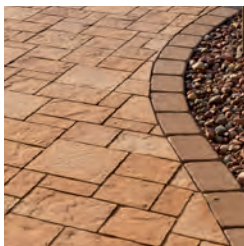

MISTA RANDOM PAVER

(page 92)



VALET PAVER

(page 96)



VILLAGIO PAVER

(page 98)

# INSTALLATION GUIDE

## SEGMENTAL PERMEABLE PAVEMENT

### INSTALLATION OUTLINE

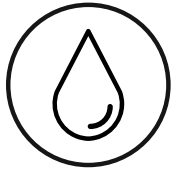

#### 01 DATA COLLECTION

- A. Determine the size, shape, and intended use of finished areas (i.e. residential driveway, secondary commercial parking, etc.).
- B. Classify sub-grade soils.
- C. Document all existing conditions (i.e. fixed points, existing grades, site contours, etc.).
- D. Document soil type, location, and elevation of below grade and overhead utilities both public and private.
- E. Ensure public utilities are marked through the use of a locating service.
- F. Determine the cross section design of the system based on soil type and application, showing proposed sub-grade and finished grade elevations and all geotextiles and drainage pipes needed for the construction.
- G. Establish the type, location, and elevation of relief structures if required (i.e. overflow pipe discharging to rain garden, etc.).
- H. Determine the curb or edge restraint type, elevation, and location.
- I. Choose a pattern appropriate to the application (traffic type and load).

#### 02 EXCAVATION

- A. Before digging, contact the concerned companies if wires or pipes are located in the area to be excavated.
- B. Excavation depth is determined from the foundation thickness according to the project specifications (foundation thickness is determined by a qualified engineer based on structural and hydrological analyses).
- C. Although the slope of the sub-grade will depend on the drainage design and infiltration type, a minimum slope of 0.5% (1/8" per ft, or 5 mm per meter) is recommended.
- D. The distance that the excavated area should extend beyond the area to be paved should be one to 1.5 times the thickness of the foundation. This extra space will ensure the stability of the pavers near the edge and the edge restraints.
- E. Level the bottom of the excavated area with a rake.

Compaction will reduce the permeability of the sub-grade and it should be executed according to the project specifications. If compaction is not specified, care should be taken to maintain undisturbed soil infiltration during excavation and construction. Stabilization of the sub-grade may be required with weak, continually saturated soils, or when subject to high traffic conditions. If the compaction or stabilization of sub-grade is necessary, reduced infiltration may require drainage pipes within the sub-base to conform to storm water drainage requirements.

#### 03 GEOTEXTILE, IMPERMEABLE LINERS, AND DRAIN PIPES

- A. Use the geotextile specified and install it according to project specifications. The use of a woven geotextile with bi-axel strength that meets design criteria is recommended.
- B. Place the geotextile on the bottom and sides of the soil sub-grade. Eliminate wrinkles in the geotextile and ensure it is not damaged during construction.
- C. Overlap of geotextile should be a minimum of 2' (600 mm) in the direction of drainage. Overlapping should be "shingle" style with respect to any slope direction and base stone distribution direction. Keep properly tensioned, eliminate wrinkles, and avoid damaging fabric (no spikes).
- D. If impermeable liners are required, install them according to project specifications and manufacturer's instructions. Impermeable liners are used when full exfiltration from the reservoir (sub-base and base) into the underlying sub grade is not allowed (no infiltration design). Perforated drainage pipes are usually required in no infiltration and partial infiltration designs.
- E. If drainage pipes are required, install them according to project specifications. The aggregate cover over drainage pipes should be at least 12" (300 mm) to protect them from damage during sub-base or base compaction.

# INSTALLATION GUIDE

## SEGMENTAL PERMEABLE PAVEMENT

### INSTALLATION OUTLINE

#### 04 SUB-BASE

For residential pedestrian applications, the sub-base may not be required and then only ASTM No. 57 (CSA 5-28) aggregate base layer with a minimum thickness of 6" (150 mm) can be used (use a thicker base for additional water storage). Refer to Base (see below 06).

When traffic load, soil conditions, and climate require greater than 12" (300 mm) of base or volume requirements for detention are higher, a sub-base may be required. Use sub-base ASTM No. 2 or No. 3 (CSA 40-80) meeting the following requirements:

- 90% fractured symmetrical particles
  - Less than 5% passing the 200 sieve
  - Industry hardness tested
- A. Moisten, spread and compact the ASTM No. 2 (CSA 40-80) aggregate sub-base in minimum 6" (150 mm) lifts (without distorting or damaging the geotextile) according to the project specifications.
  - B. Make at least two passes in the vibratory mode followed by at least two passes in the static mode with a minimum 10 ton (9 metric ton) vibratory roller, until there is no visible movement of the aggregate. Alternately, a 13,500 lbf (60 kN) plate compactor can be used to compact the ASTM No. 2 (CSA 40-80) aggregate sub-base.
  - C. Do not allow the compactor to crush the aggregate.
  - D. Surface tolerance of the ASTM No. 2 (CSA 40-80) sub-base should be  $\pm 2 \frac{1}{2}$ " (64 mm) over 10' (3 m).

#### 05 EDGE RESTRAINT

- A. Install edge restraint according to project specifications.
- B. Depending on the design, the top of the edge restraint can be hidden or exposed.
- C. Install Avignon, Belgik or Pietra edge units. Cast-in-place concrete or precast concrete curbs should be considered in vehicular use applications (commercial / industrial driveways, parking lots or streets).
- D. Edge restraint may rest on an open-graded or dense-graded aggregate base.

#### 06 BASE

- A. Moisten, spread and compact the ASTM No. 57 (CSA 5-28) aggregate base layer in one 4" (100 mm) thick lift.
- B. Make a minimum of two passes in vibratory mode followed by at least two in static mode with a minimum 10 ton (9 metric ton) vibratory roller, until there is no visible movement of the aggregate. Alternately, a 13,500 lbf (60 kN) plate compactor can be used to compact the ASTM No. 57 (CSA 5-28) aggregate base.
- C. Do not allow the compactor to crush the aggregate.
- D. Surface tolerance of the ASTM No. 57 (CSA 5-28) base should be  $\pm 1$ " (25 mm) over 10' (3 m). Verify prior to setting bed installation.

#### 07 BEDDING COURSE

- A. Moisten, spread and screed the ASTM No. 8 (CSA 2.5-10) aggregate bedding layer in one 2" (50 mm) thick lift.
- B. Surface tolerance of the ASTM No. 8 (CSA 2.5-10) bedding course should be  $\pm \frac{3}{8}$ " (10 mm) over 10' (3 m).
- C. Construction equipment and pedestrian traffic on the screeded bedding course should not be permitted.

#### 08 PAVER

- A. Pavers should be placed in the pattern shown on the drawings. Lay units hand tight to designated laying patterns. Units have lugs to maintain consistent joint width.
- B. In sloped conditions, it is preferable to start laying from the bottom in an uphill direction.
- C. The minimum slope recommended for permeable pavement surface is 1%.
- D. Hydra pavers can be installed with a mechanical tool to expedite installation.
- E. When subject to vehicular traffic, cut units should not be smaller than  $\frac{1}{3}$  of a whole paver. When using cut pieces, maintain joint.
- F. In vehicular applications, pattern strength will increase if laying pattern is perpendicular to traffic flow.

# INSTALLATION GUIDE

## SEGMENTAL PERMEABLE PAVEMENT

### INSTALLATION OUTLINE

#### 09 JOINT FILL

- A. Fill the paver joint openings with ASTM No. 8 (CSA 2.5-10) aggregate (or No. 89, No. 9 depending on joint width). Sweep stone to fill joints. Surface must be swept clean prior to compaction.
- B. Compact with a minimum 5,000 lbf (22 kN) plate compactor (two passes minimum). The installation of a neoprene pad is recommended to protect the texture of the paving units.
- C. Do not compact within 6' (1.8 m) of unrestrained edges of the pavers.
- D. Apply additional aggregate to fill the joint openings if needed and compact.
- E. Surface tolerance of compacted pavers should be  $\pm \frac{3}{8}$ " (10 mm) over 10' (3 m).

#### QUANTITY CHART FOR PERMEABLE JOINTS

Approximate clean stone quantity in kg (lb) to cover an area of 1 m<sup>2</sup> (1 pi<sup>2</sup>) to fill between joints.  
*It is recommended to always start with a small area.*

PRODUCTS	JOINT FILL MATERIAL	(lbs/sq. ft)	(kg/sq. m)
Antika	ASTM No. 8 (CSA 2.5 - 10) (¼")	1.9	9.3
Aquastorm	ASTM No. 8 (CSA 2.5 - 10) (¼")	12.2	59.5
Blu 60 mm & Blu 60 (6×13)	ASTM No. 9 (CSA 2.5 - 5) (⅛")	0.6	3.0
Blu 60 mm (6×13)	ASTM No. 9 (CSA 2.5 - 5) (⅛")	0.9	4.2
Blu 80 mm & Blu 80 (6×13)	ASTM No. 9 (CSA 2.5 - 5) (⅛")	0.8	4.0
Blu 80 mm (6×13)	ASTM No. 9 (CSA 2.5 - 5) (⅛")	1.2	5.7
Hydra	ASTM No. 8 (CSA 2.5 - 10) (¼")	2.9	14.4
Mika	ASTM No. 8 (CSA 2.5 - 10) (¼")	2.5	12.2
Mista random	ASTM No. 9 (CSA 2.5 - 5) (⅛")	1.0	5.0
Oxford	ASTM No. 8 (CSA 2.5 - 10) (¼")	1.8	8.7
Pure	ASTM No. 8 (CSA 2.5 - 10) (¼")	1.4	7.0
Valet	ASTM No. 9 (CSA 2.5 - 5) (⅛")	1.3	6.2
Villagio	ASTM No. 8 (CSA 2.5 - 10) (¼")	2.1	10.2

**Note:** Gator Aqua Rock permeable stone (bagged) can be used to meet the ASTM No. 9 gradation.

#### 10 POST INSTALLATION PROTECTION

Prevent contamination of the porous (permeable) pavement system from fine aggregates and debris by maintaining erosion and sedimentation (E&S) measures at the perimeter.



# AQUASTORM

DESCRIPTION: Paver TEXTURE: Smooth



Specifications per pallet		Imperial	Metric	
 56 units / pallet	Product dimension (L x W x H)	20 1/8 x 10 1/8 x 3 15/16	510 x 255 x 100	
	Cubing	78.39 ft <sup>2</sup>	7.28 m <sup>2</sup>	
	Approx. Weight	2 245 lbs	1 018 kg	
	Number of rows	7		
	Coverage per unit	11.20 ft <sup>2</sup>	1.04 m <sup>2</sup>	
	Lin. coverage per row	Depth	13.39 lin. ft	4.08 lin. m
		Length	6.69 lin. ft	2.04 lin. m

## Pallet Overview

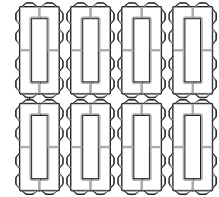

## Laying Patterns Options

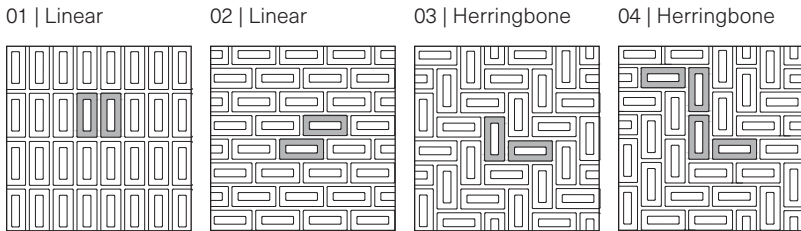

Patterns are for design inspiration only. The installer is responsible to calculate & purchase the correct amount of material.

## NOTES

See page 6 for icons description.  
 See page 27 for more information about applications.  
 See page 62 to 64 for more technical information.  
 When used in a permeable pavement application, see page 28 and 105 for more technical information.  
**JOINT WIDTH:** 1 5/8" (41 mm)  
**% OF SURFACE OPENING:** 38 %  
**INFILTRATION RATE:** 2 395 in./hr (60 842 mm/hr)

**WINTER CONDITIONS**  
 De-icing salts should never be used on grass as salt will damage it. The snowblower blade should be set to leave a 3/4 to 1 1/2 in. (2 to 4 cm) tamped snow cover to protect the grass from extreme cold and prevent it from being torn off during snow removal.  
 Grid pavers are ideal for emergency and service access lanes, boat ramps, and slope protection.

Aquastorm paver meet and exceeds the requirements of ASTM C1319 for Concrete Grid Paving Units.  
 Please note that for barefoot walking areas (e.g. pool deck) dark-colored paving units could get very hot under the sun.



# HYDRA

**DESCRIPTION:** Paver **TEXTURE:** Smooth

### Pallet Overview

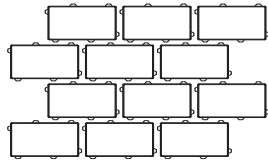

### Specifications per pallet



96 units / pallet

	Imperial	Metric
Product dimension (L x W x H)	11 13/16 x 7 7/8 x 3 15/16	300 x 200 x 100
Cubing	62 ft <sup>2</sup>	5.76 m <sup>2</sup>
Approx. Weight	2 811 lbs	1 275 kg
Number of rows	8	
Coverage per row	7.75 ft <sup>2</sup>	0.72 m <sup>2</sup>
Lin. coverage per row	11.80 lin. ft	3.60 lin. m



Smooth Chestnut Brown  
 Smooth Grey  
 Smooth Greyed Nickel\*  
 Smooth Shale Grey  
 Smooth Onyx Black

### Laying Patterns Options

01 | Linear

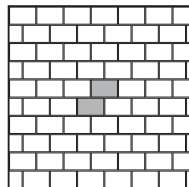

Patterns are for design inspiration only. The installer is responsible to calculate & purchase the correct amount of material.

### NOTES

See page 6 for icons description.  
 See page 27 for more information about applications.  
 See page 28 and 105 for more technical information.  
**JOINT WIDTH:** 1/2" ( 13 mm)  
**% OF SURFACE OPENING:** 8.3 %  
**INFILTRATION RATE:** 605 in./hr (15 345 mm/hr)  
 Please note that for barefoot walking areas (e.g. pool deck) dark-colored paving units could get very hot under the sun.  
**\*Greyed Nickel is made-to-order, minimum order of 2,000 sq. ft. Deposit required.**

### CHARACTERISTICS

- Clamp or Mechanical tool available for machine installation. Check with your local Techo-Bloc representative for more information.
- 6000 to 8000 sq. ft can be installed per day with mechanical installation and a team of 5 persons
- LEED® Projects.
- Reduces stormwater runoff to municipal sewers.
- Eliminates the need for retention basins and optimizes the use of land.



# MIKA

DESCRIPTION: Paver TEXTURE: Klean-Bloc Slate



## Specifications per pallet

		Imperial	Metric	
 320 units / pallet	Product dimension (L x W x H)	11 x 4 7/8 x 2 3/4	279 x 112 x 70	
	Cubing	107.63 ft <sup>2</sup>	10.00 m <sup>2</sup>	
	Approx. Weight	3 012 lbs	1 366 kg	
	Number of rows	10		
	Coverage per unit	10.76 ft <sup>2</sup>	1.00 m <sup>2</sup>	
	Lin. coverage	Depth	11.77 lin. ft	3.59 lin. m
	per row	Length	29.25 lin. ft	8.92 lin. m

## Pallet Overview

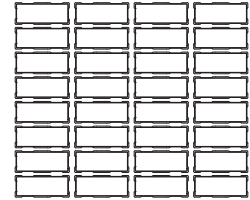

## Laying Patterns Options

01 | Linear

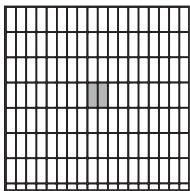

02 | Linear

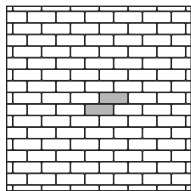

03 | Herringbone

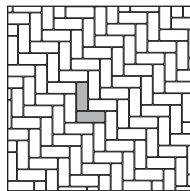

04 | Herringbone

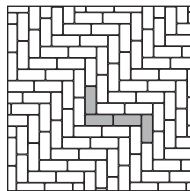

Patterns are for design inspiration only. The installer is responsible to calculate & purchase the correct amount of material.

## NOTES

See page 6 for icons description.

See page 27 for more information about applications.

See page 62 to 64 for more technical information. When used in a permeable pavement application, see page 100 to 105 for more technical information.

**JOINT WIDTH:** 5/8" ( 15 mm)

**% OF SURFACE OPENING:** 7.8 %

**INFILTRATION RATE:** 909 in./hr(23 094 mm/hr)

Please note that for barefoot walking areas (e.g. pool deck) dark-colored paving units could get very hot under the sun.

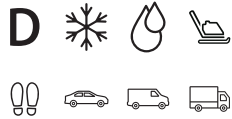

# PURE

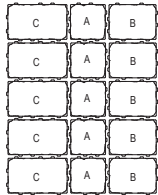

**DESCRIPTION:** Paver **TEXTURE:** Beveled

### Pallet Overview\*



Beveled  
Chestnut Brown  
Beveled  
Champlain Grey  
Beveled  
Shale Grey

### Specifications per pallet

	Imperial	Metric
<b>A</b>  Product dimension (L x W x H) <b>A</b>	9 x 9 x 3 1/8"	229 x 229 x 80
40 units / pallet		
<b>B</b>  Product dimension (L x W x H) <b>B</b>	12 x 9 x 3 1/8"	305 x 229 x 80
40 units / pallet		
<b>C</b>  Product dimension (L x W x H) <b>C</b>	15 x 9 x 3 1/8"	381 x 229 x 80
40 units / pallet		
<b>Cubing</b>	90 ft <sup>2</sup>	8.36 m <sup>2</sup>
<b>Approx. Weight</b>	3 175 lbs	1 440 kg
<b>Number of rows</b>	8	
<b>Coverage per row</b>	11.25 ft <sup>2</sup>	1.05 m <sup>2</sup>
<b>Lin. coverage per row</b>	15 lin. ft	4.57 lin. m

### Laying Patterns Options

01 | Linear      02 | Herringbone      02 | Modified Herringbone

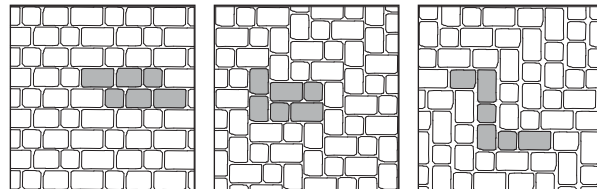

Patterns are for design inspiration only. The installer is responsible to calculate & purchase the correct amount of material.

### NOTES

See page 6 for icons description.

See page 62 to 64 for more technical information. When used in a permeable pavement application, see page 100 to 105 for more technical information.

See page 27 for more information about applications.

**JOINT WIDTH:** 3/8" (10 mm)  
**% OF SURFACE OPENING:** 5.0 %  
**INFILTRATION RATE:** 726 in./hr (18 440 mm/hr)

The use of permeable pavement systems throughout the world has proven effective in reducing storm water runoff while increasing infiltration rates as it returns the water to the environment. The use of permeable pavers also facilitates LEED® certification easier to obtain.





Please note that for barefoot walking areas (e.g. pool deck) dark-colored paving units could get very hot under the sun.



# SAINT-OXFORD

DESCRIPTION: Paver TEXTURE: Klean-Bloc Slate



Specifications per pallet*		Imperial	Metric
	Product dimension (L x W x H) <b>A</b>	6 5/16 x 4 3/4 x 2 3/4	166 x 121 x 70
	Product dimension (L x W x H) <b>B</b>	8 1/16 x 4 3/4 x 2 3/4	204 x 121 x 70
93 units / pallet	Product dimension (L x W x H) <b>C</b>	9 5/16 x 4 3/4 x 2 3/4	242 x 121 x 70
	Product dimension (L x W x H) <b>D</b>	11 1/16 x 4 3/4 x 2 3/4	280 x 121 x 70
	Cubing	122.44 ft <sup>2</sup>	11.38 m <sup>2</sup>
	Approx. Weight	3 494 lbs	1 585 kg
106 units / pallet	Number of rows	10	
	Coverage per row	12.24 ft <sup>2</sup>	1.14 m <sup>2</sup>
	Lin. coverage per row	30.84 lin. ft	9.40 lin. m
			
80 units / pallet			
134 units / pallet			

## Pallet Overview\*

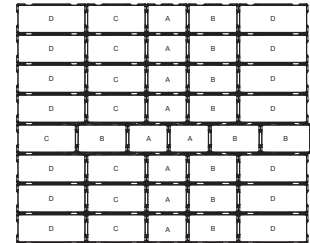

Bordeaux Red

Klean-Bloc Slate

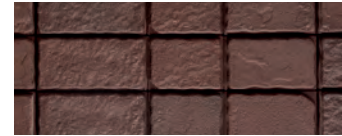

Sepia Brown

Klean-Bloc Slate



Midnight Grey

Klean-Bloc Slate



Onyx Black

Klean-Bloc Slate



## Laying Patterns Options

01 | Linear

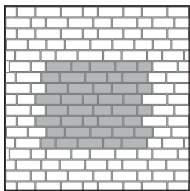

Patterns are for design inspiration only. The installer is responsible to calculate & purchase the correct amount of material.

## NOTES

See page 6 for icons description.

See page 27 for more information about applications.

See page 62 to 64 for more technical information. When used in a permeable pavement application, see page 100 to 105 for more technical information.

JOINT WIDTH: 3/16" (10mm)

% OF SURFACE OPENING: 7.3 %

\*The layout and number of units per pallet may vary but the total coverage per pallet remains the same.

Please note that for barefoot walking areas (e.g. pool deck) dark-colored paving units could get very hot under the sun.

# OUTDOOR FEATURES



Lumi Firebowl P. 112  
Lumi Planter P. 113  
Sculptura Collection P. 114  
Brandon Rectangle P. 117  
Brandon Square P. 119

Prescott P. 121  
Raffinato P. 123  
Valencia P. 125  
HPC Burners P. 127  
Breeo Accessories P. 128



## LUMI Firebowl

Specifications per pallet	Imperial	Metric
Approx. Weight	395 lbs	179 kg
Overall Height	17 in	432 mm
Exterior Diameter	34 in	864 mm
Interior Diameter	31 in	787 mm

Warm Grey

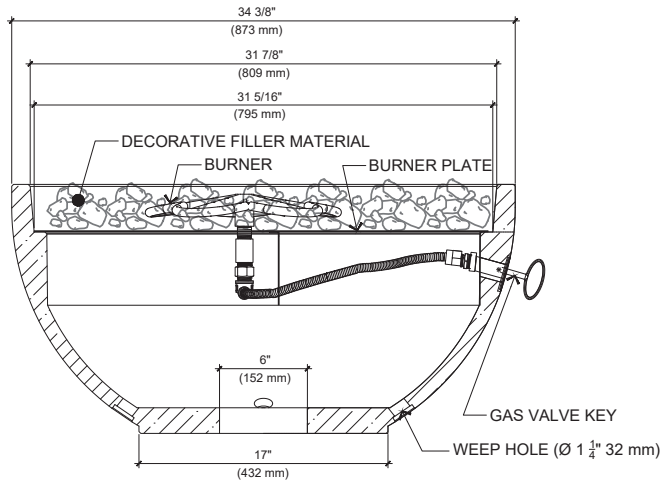
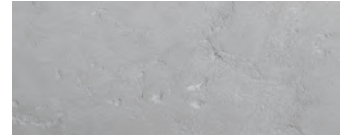

### NOTES

**INCLUDES:**  
Burner, pan, Dante valve, lava rock and protective cover.

Fire Pit comes with UGO (Universal Gas Orifice) for natural gas & liquid propane burning options.

See page 6 for icons description.

### HPC BURNER

**HPC BURNERS**

**FEATURES:**  
Natural Gas or Liquid Propane  
Standard BTU: 65K

**INCLUDES:**  
Stainless steel burner and pan, Dante valve, lava rock.  
See page 127 for details.

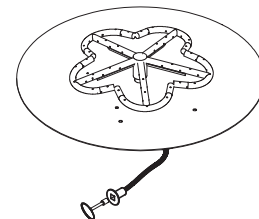



# LUMI Planter

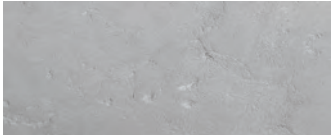

Warm Grey



Specifications per pallet	Imperial	Metric
Approx. Weight	395 lbs	179 kg
Overall Height	17 in	432 mm
Exterior Diameter	34 in	864 mm
Interior Diameter	31 in	787 mm

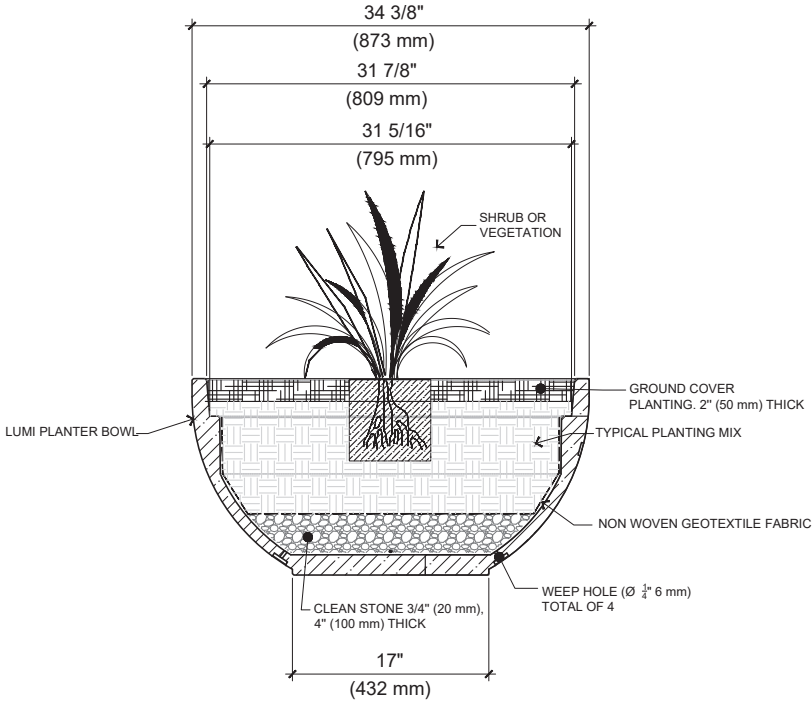

### NOTES

See page 6 for icons description.  
 Total Inside Volume: 5.35 ft<sup>3</sup> (0.15 m<sup>3</sup>)



## SCULPTURA FIRE PIT Square

DESCRIPTION: Fire pit TEXTURE: Smooth

Specifications per pallet	Imperial	Metric
Approx. Weight*	530 lbs	240 kg
Overall Height	14.5 in	368 mm
Overall Width	40 in	1 016 mm
Overall Length	40 in	1 016 mm

Cool Grey

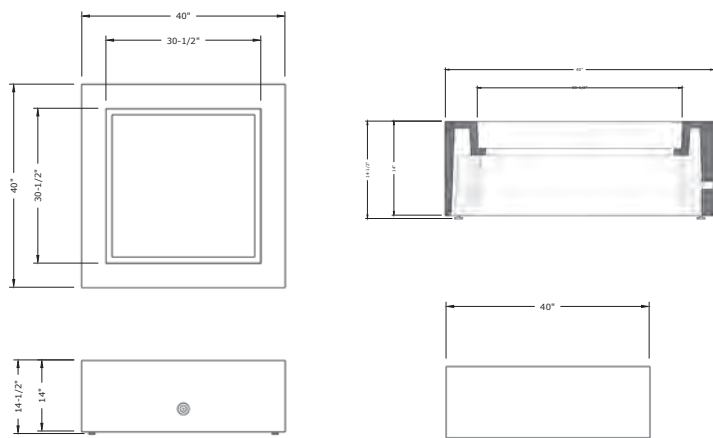
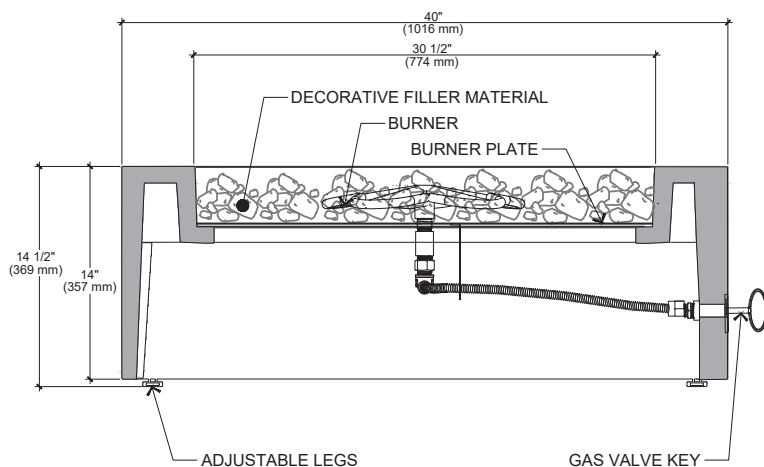

### NOTES

**INCLUDES:**

Burners, pan, Dante valve, lava rock and protective cover. Fire Pit comes with UGO (Universal Gas Orifice) for natural gas & liquid propane burning options.

\*Includes weight of accessories.

\*\*Glass wind guard sold separately.

Visit [techo-bloc.com](http://techo-bloc.com) to discover more.

See page 6 for icons description.

### HPC BURNERS

**HPC BURNERS**

**FEATURES:**

Natural Gas or Liquid Propane  
Standard BTU: 65K

**INCLUDES:**

Stainless steel burner and pan, Dante valve, lava rock. See page 127 for details.

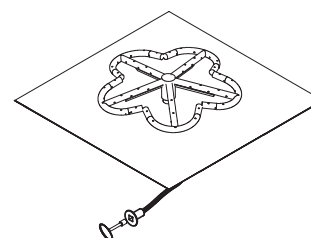



# SCULPTURA FIRE PIT Rectangle

DESCRIPTION: Fire pit TEXTURE: Smooth



Cool Grey

Specifications per pallet	Imperial	Metric
Approx. Weight*	506 lbs	230 kg
Overall Height	14.5 in	368 mm
Overall Width	24 in	610 mm
Overall Length	52 in	1 321 mm

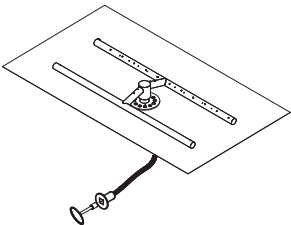
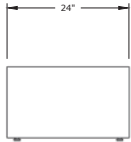
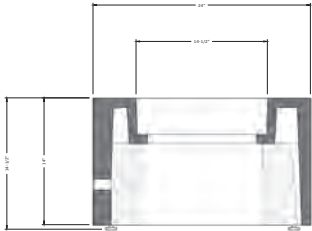
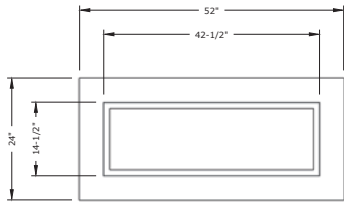
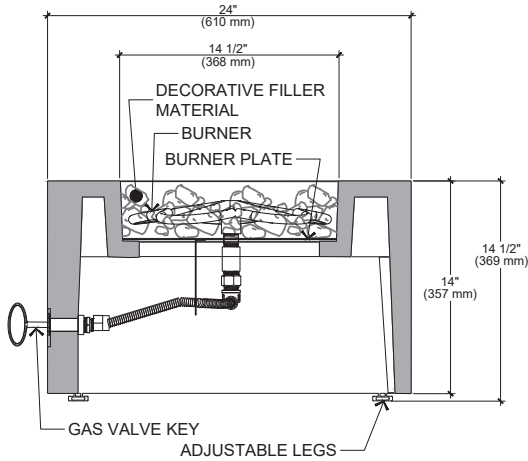

## HPC BURNERS

### HPC BURNERS

**FEATURES:**  
Natural Gas or Liquid Propane  
Standard BTU: 65K

**INCLUDES:**  
Stainless steel burner and pan, Dante valve, lava rock.  
See page 127 for details.

## NOTES

**INCLUDES:**  
Burners, pan, Dante valve, lava rock and protective cover.  
Fire Pit comes with UGO (Universal Gas Orifice) for natural gas & liquid propane burning options.  
\*Includes weight of accessories.  
\*\*Glass wind guard sold separately.  
Visit [techo-bloc.com](http://techo-bloc.com) to discover more.  
See page 6 for icons description.



# SCULPTURA FIRE PIT Circle & Scalloped

DESCRIPTION: Fire pit TEXTURE: Smooth

## CIRCLE

Specifications per pallet	Imperial	Metric
Approx. Weight*	439 lbs	199 kg
Overall Height	14.5 in	368 mm
Exterior Diameter	40 in	1 016 mm

## SCALLOPED

Specifications per pallet	Imperial	Metric
Approx. Weight*	439 lbs	199 kg
Overall Height	14.5 in	368 mm
Exterior Diameter	40 in	1 016 mm

Cool Grey



CIRCLE



SCALLOPED

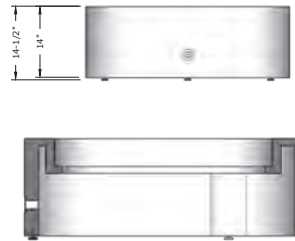
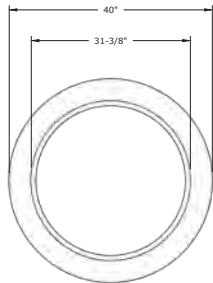
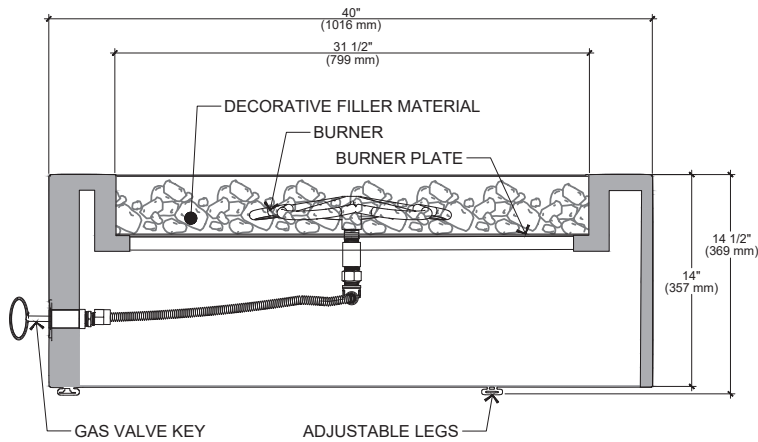

## NOTES

**INCLUDES:**  
Burners, pan, Dante valve, lava rock and protective cover.  
Fire Pit comes with UGO (Universal Gas Orifice) for natural gas & liquid propane burning options.  
\*Includes weight of accessories.  
\*\*Currently Techo-Bloc does not offer a wind guard option for circular firepits.  
See page 6 for icons description.

## HPC BURNERS

**HPC BURNERS**  
**FEATURES:**  
Natural Gas or Liquid Propane  
Standard BTU: 65K

**INCLUDES:**  
Stainless steel burner and pan, Dante valve, lava rock.  
See page 127 for details.

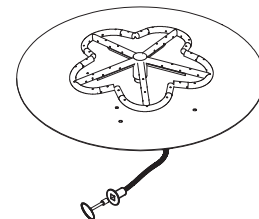

# D

TECHO-BLOC WARRANTY APPLIES TO BRANDON STONES. THE WARRANTY DOES NOT APPLY TO ACCESSORY KIT.

## BRANDON Rectangular Fire pit

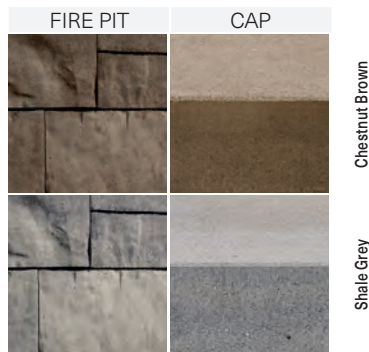

Specifications per pallet	Imperial	Metric
Cubing	58 units	58 units
Approx. Weight	2 660 lbs	1 207 kg
Overall Height	19 15/16 in	507 mm
Overall Width	44 1/2 in	1 130 mm
Overall Length	57 3/4 in	1 467 mm
Brandon 90 mm units	20 units	
Brandon 90 mm corner units	30 units	
Cap units	8 units	

### Options and accessories (sold separately)

Sleeve Insert



### Wood Firepit

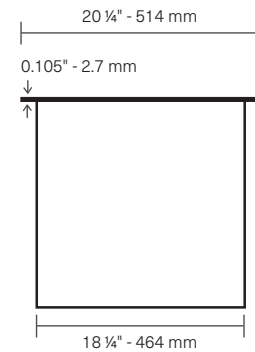
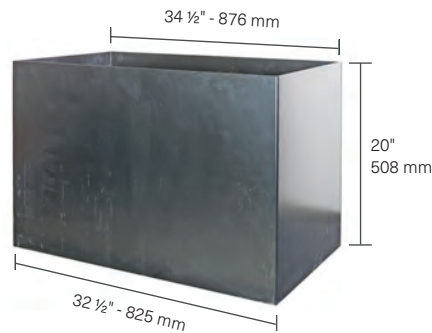

### HPC BURNERS (SOLD SEPARATELY)

#### HPC BURNERS

##### FEATURES:

Natural Gas or Liquid Propane  
Standard BTU: 65K  
Push button ignition

##### INCLUDES:

Stainless steel burner with aluminum pan, mounting brackets, Dante valve with push-button ignition, vents, lava rock and stainless steel cover.  
See page 127 for details.

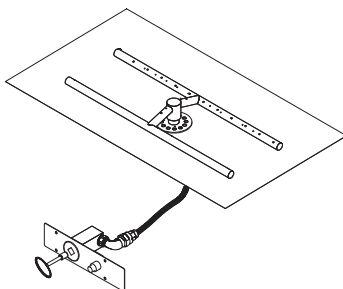

### NOTES

See page 6 for icons description.

Available with UGO (Universal Gas Orifice) for natural gas & liquid propane burning options, wood burning or smokeless wood burning.

**Sold as a kit not pre-assembled.  
Raffinato pre-cut caps included.**

**Techo-Bloc is not responsible for any damages to the firepit if it is not installed with a sleeve or accessory kit. The firepit is not designed for large fires. Fire should be contained at least 6" away**

**from the firepit wall blocks. Overheating could lead to heat damage to the firepit components.**

\*For an authentic look, each color option is composed of a variety of darker & lighter tones. Natural ingredients such as granite are present within the recipe to allow for a range in tones, veining and textures from one stone to another.

See 118 for more technical information.

**Sleeve insert, Burners and Accessories are sold separately.**

# INSTALLATION GUIDE

## BRANDON RECTANGLE, FIRE PIT (KIT)

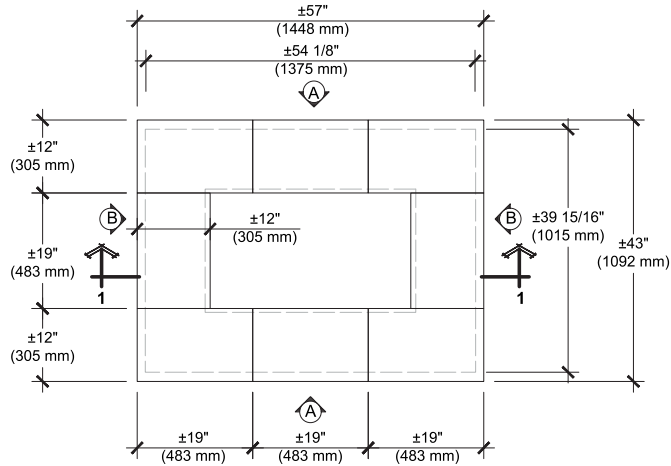

TOP

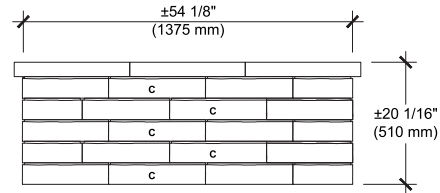

ELEVATION A

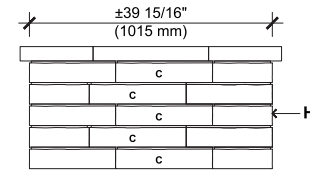

ELEVATION B

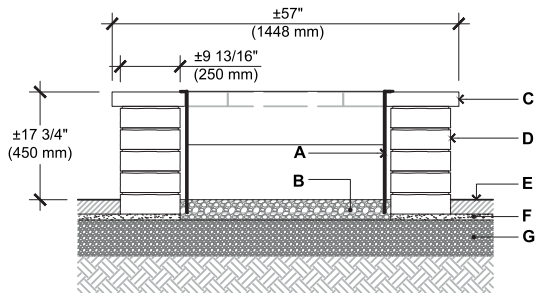

SECTION 1-1

- A. STEEL BOX INSERT
- B. CLEAN STONE  $\frac{3}{4}''$  (20 mm), 4" (100 mm) THICK
- C. RAFFINATO CAP 60 mm (PRE-CUT)
- D. BRANDON 90 mm BLOCK
- E. TECO-BLOC PAVERS OR SLABS
- F. SETTING BED 1" (25 mm)
- G. COMPACTED GRANULAR BASE 0- $\frac{3}{4}''$  (0-20 mm)
- H. BRANDON 90 mm CORNER BLOCK

### QUANTITY OF MATERIALS REQUIRED

- RAFFINATO CAP 60 mm: 8
- Brandon 90 mm block **C**: 20
- Brandon 90 mm corner block: 30

**NOTE:** Secure the blocks using a heat resistant concrete adhesive. The installer must ensure that the installation and use of the fire pit comply with local regulations and code requirements.

Consult our Installation Guide in our website for a detail step by step installation.

# D

TECHO-BLOC WARRANTY APPLIES TO BRANDON STONES. THE WARRANTY DOES NOT APPLY TO ACCESSORY KIT.

## BRANDON Square Fire pit

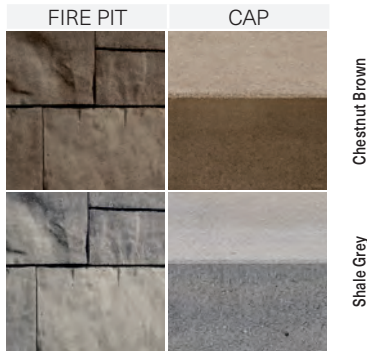

### HPC BURNERS AND BREEO ACCESSORIES (SOLD SEPARATELY)

#### HPC BURNERS

##### FEATURES:

Natural Gas or Liquid Propane  
Standard BTU: 65K  
Push button ignition

##### INCLUDES:

Stainless steel burner with aluminum pan, mounting brackets, Dante valve with push-button ignition, vents, lava rock and stainless steel cover.  
See page 127 for details.

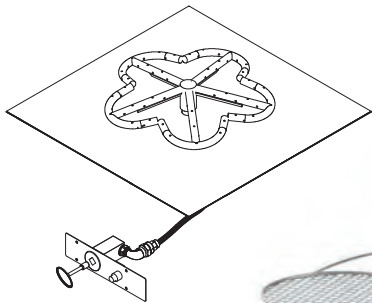

#### GRILLING SYSTEM OUTPOST™

Only for Smokeless inserts

Transforms fire pit into wood-fired grill.  
Weight: 12 lbs. 9 oz.  
Diameter: 22 inches  
See page 128 for details.



#### Specifications per pallet

	Imperial	Metric
Cubing	66 units	66 units
Approx. Weight	2 454 lbs	1 113 kg
Overall Height	19 15/16 in	507 mm
Overall Width	53 1/2 in	1 359 mm
Overall Length	53 1/2 in	1 359 mm
Brandon 90 mm units	20 <b>A</b> units	20 <b>B</b> units
Brandon 90 mm corner units	20 units	
Cap units	6 units	

#### Options and accessories (sold separately)

##### Sleeve Insert

##### Wood Firepit

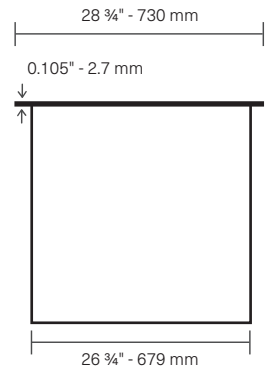
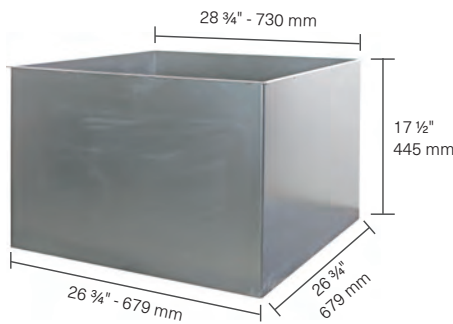

##### Smokeless Insert

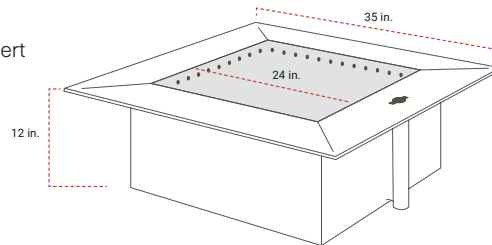

#### NOTES

See page 6 for icons description.

Available with UGO (Universal Gas Orifice) for natural gas & liquid propane burning options, wood burning or smokeless wood burning.

**Sold as a kit not pre-assembled.**  
**Raffinato pre-cut caps included.**

**Techo-Bloc is not responsible for any damages to the firepit if it is not installed with a sleeve or accessory kit. The firepit is not designed for large fires. Fire should be contained at least 6\"/>**

**from the firepit wall blocks. Overheating could lead to heat damage to the firepit components.**

\*For an authentic look, each color option is composed of a variety of darker & lighter tones. Natural ingredients such as granite are present within the recipe to allow for a range in tones, veining and textures from one stone to another.

See 120 for more technical information.

**Sleeve insert, Burners and Accessories are sold separately.**

# INSTALLATION GUIDE

## BRANDON SQUARE, FIRE PIT (KIT)

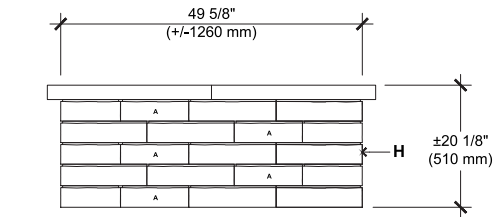
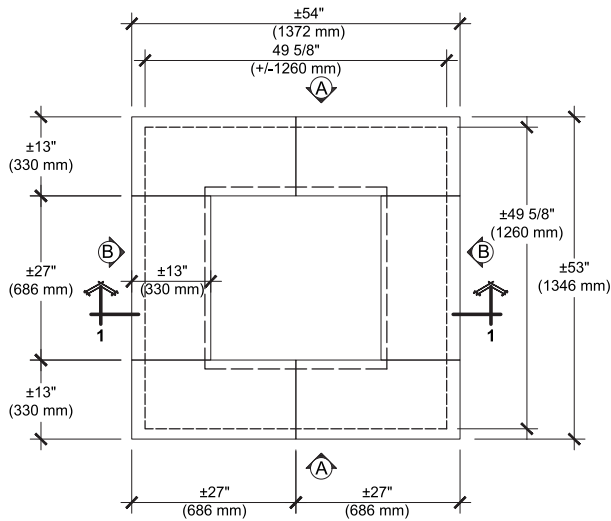

ELEVATION A

TOP

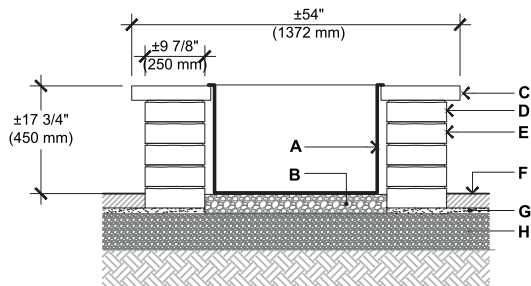

SECTION 1-1

- A.** STEEL BOX INSERT
- B.** CLEAN STONE ¾" (20 mm), 4" (100 mm) THICK
- C.** RAFFINATO CAP 60 mm (PRE-CUT)
- D.** BRANDON 90 mm BLOCK
- E.** TECO-BLOC PAVERS OR SLABS
- F.** SETTING BED 1" (25 mm)
- G.** COMPACTED GRANULAR BASE 0-¾" (0-20 mm)
- H.** BRANDON 90 mm CORNER BLOCK

### QUANTITY OF MATERIALS REQUIRED

- RAFFINATO CAP 60 mm: 6
- Brandon 90 mm block: 20 **A**, 20 **B**,
- Brandon 90 mm corner block: 20

**NOTE :** Secure the blocks using a heat resistant concrete adhesive. The installer must ensure that the installation and use of the fire pit comply with local regulations and code requirements.

Consult our Installation Guide in our website for a detail step by step installation.

# W

TECHO-BLOC WARRANTY APPLIES TO PRESCOTT STONES. THE WARRANTY DOES NOT APPLY TO ACCESSORY KIT.

## PRESCOTT

DESCRIPTION: Fire pit TEXTURE: Chiseled Face



Specifications per pallet	Imperial	Metric
Approx. Weight	2 813 lbs	1276 kg
Height	18 in	457 mm
Depth	51 ¾ in	1 314 mm
Length	51 ¾ in	1 314 mm
Piedimonte caps	6	
Prescott 2,25" block	7 <b>A</b> , 18 <b>B</b> , 7 <b>C</b>	
Prescott 4,5" block	3 <b>A</b> , 6 <b>B</b> , 3 <b>C</b>	
Prescott 2,25" corner block	16	
Prescott 4,5" corner block	6	

### HPC BURNERS AND BREEO ACCESSORIES (SOLD SEPARATELY)

#### HPC BURNERS

##### FEATURES:

Natural Gas or Liquid Propane  
Standard BTU: 65K  
Push button ignition

##### INCLUDES:

Stainless steel burner with aluminum pan, mounting brackets, Dante valve with push-button ignition, vents, lava rock and stainless steel cover.  
See page 127 for details.

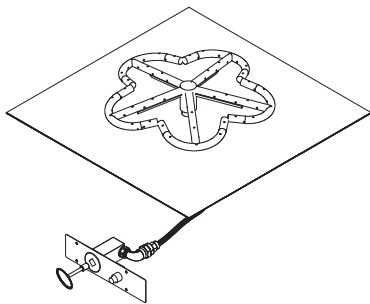

#### GRILLING SYSTEM OUTPOST™

Only for Smokeless inserts

Transforms fire pit into wood-fired grill.  
Weight: 12 lbs. 9 oz.  
Diameter: 22 inches  
See page 128 for details.



#### Options and accessories (sold separately)

Sleeve Insert

Wood Firepit

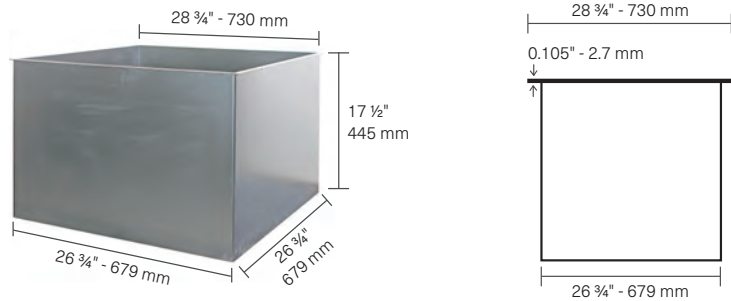

Smokeless Insert

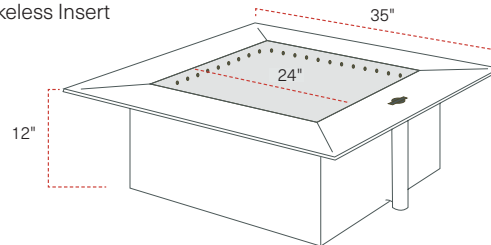

#### NOTES

See page 6 for icons description.

Available with UGO (Universal Gas Orifice) for natural gas & liquid propane burning options, wood burning or smokeless wood burning.

**Sold as a kit not pre-assembled.**  
**Piedimonte caps included.**

**Techo-Bloc is not responsible for any damages to the firepit if it is not installed with a sleeve or accessory kit. The firepit is not designed for large fires. Fire should be contained at least 6" away**

**from the firepit wall blocks. Overheating could lead to heat damage to the firepit components.**

\*For an authentic look, each color option is composed of a variety of darker & lighter tones. Natural ingredients such as granite are present within the recipe to allow for a range in tones, veining and textures from one stone to another.

**OPTIONS AND ACCESSORIES are SOLD SEPARATELY.**

See 122 for more technical information.

# INSTALLATION GUIDE

## PRESCOTT FIRE PIT (KIT)

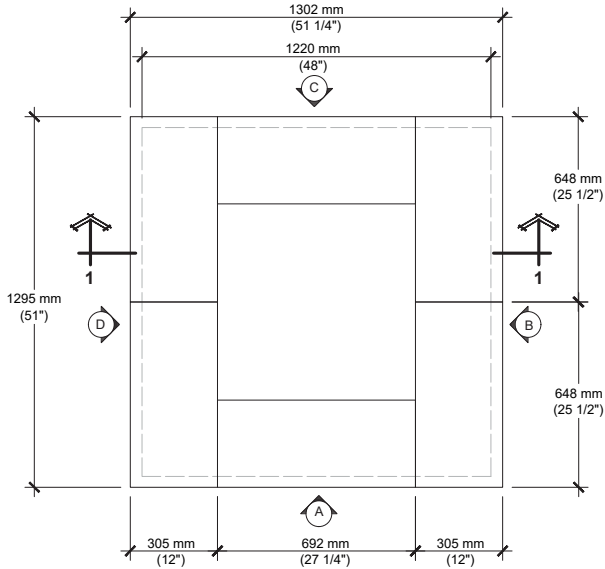

TOP

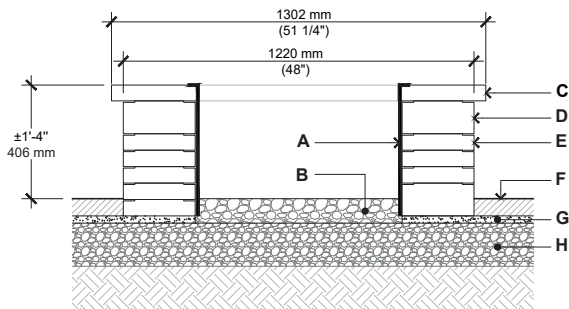

SECTION 1-1

- A. STEEL BOX INSERT
- B. CLEAN STONE 3/4" (20 mm), 4" (100 mm) THICK
- C. PIEDIMONTE CAP (CUT)
- D. PRESCOTT 4.5" BLOCK
- E. PRESCOTT 2.25" BLOCK
- F. TECO-BLOC PAVERS OR SLABS
- G. SETTING BED 1" (25 mm)
- H. COMPACTED GRANULAR BASE 0-3/4" (0-20 mm) (SEE TABLE PAGE 64 FOR THICKNESS)
- I. PRESCOTT 4.5" CORNER BLOCK
- J. PRESCOTT 2.25" CORNER BLOCK

### QUANTITY OF MATERIALS REQUIRED

- Piedimonte cap: **6**
- Prescott 2.25" block: **7 A, 18 B, 7 C**
- Prescott 4.5" block: **3 A, 6 B, 3 C**
- Prescott 2.25" corner block: **16**
- Prescott 4.5" corner block: **6**

**NOTE:** Secure the blocks using a heat resistant concrete adhesive. The installer must ensure that the installation and use of the firepit comply with local regulations and code requirements.

 RECOMMENDED LOCATION FOR VENT ACCESSORY (GAS KIT);

 RECOMMENDED LOCATION FOR IGNITION CONTROL (GAS KIT);

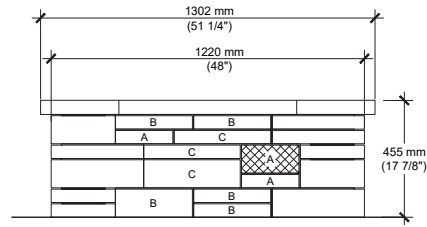

ELEVATION A

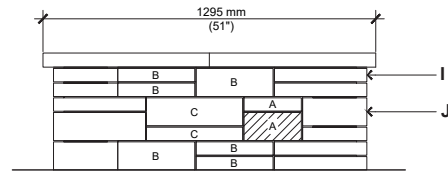

ELEVATION B

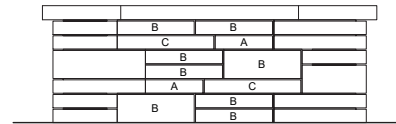

ELEVATION C

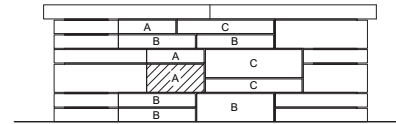

ELEVATION D

Consult our Installation Guide in our website for a detailed step by step installation.



# D

TECHO-BLOC WARRANTY APPLIES TO RAFFINATO STONES. THE WARRANTY DOES NOT APPLY TO ACCESSORY KIT.

## RAFFINATO

DESCRIPTION: Fire pit TEXTURE: Smooth

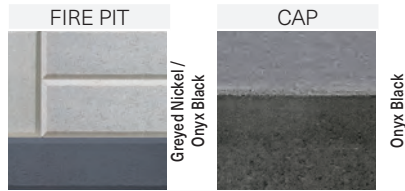

Specifications per pallet	Imperial	Metric
Approx. Weight	2 700 lbs	1 224 kg
Height	21 ¼ in	540 mm
Depth	41 ½ in	1 054 mm
Length	55 ⅞ in	1 419 mm
12" x 24" caps	8	
Raffinato 90 mm corner block	10	
Raffinato 180 mm corner block	20	

### Options and accessories (sold separately)

Sleeve Insert

### Wood Firepit

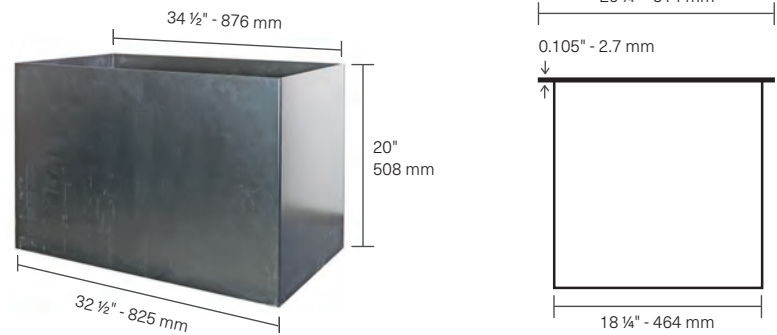

### HPC BURNERS (SOLD SEPARATELY)

#### HPC BURNERS

##### FEATURES:

Natural Gas or Liquid Propane  
Standard BTU: 65K  
Push button ignition

##### INCLUDES:

Stainless steel burner with aluminum pan, mounting brackets, Dante valve with push-button ignition, vents, lava rock and stainless steel cover.  
See page 127 for details.

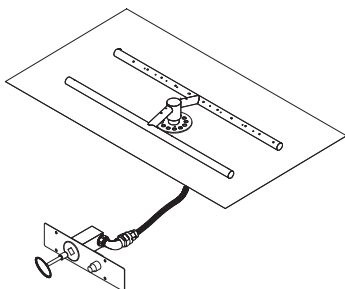

### NOTES

See page 6 for icons description.

Available with UGO (Universal Gas Orifice) for natural gas & liquid propane burning options, wood burning or smokeless wood burning.

Sold as a kit not pre-assembled.  
Raffinato pre-cut caps included.

Techo-Bloc is not responsible for any damages to the firepit if it is not installed with a sleeve or accessory kit. The firepit is not designed for large

fires. Fire should be contained at least 6" away from the firepit wall blocks. Overheating could lead to heat damage to the firepit components.

OPTIONS AND ACCESSORIES are SOLD SEPARATELY.

See 124 for more technical information.

# INSTALLATION GUIDE

## RAFFINATO FIRE PIT (KIT)

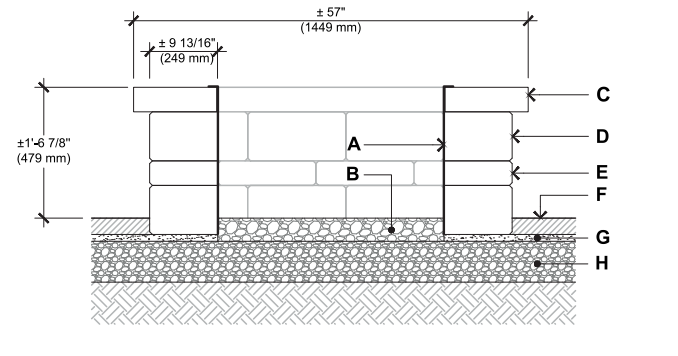
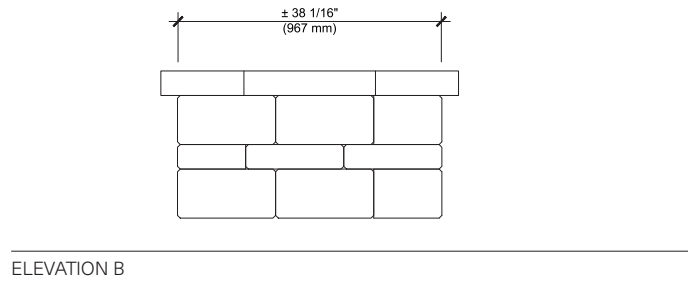
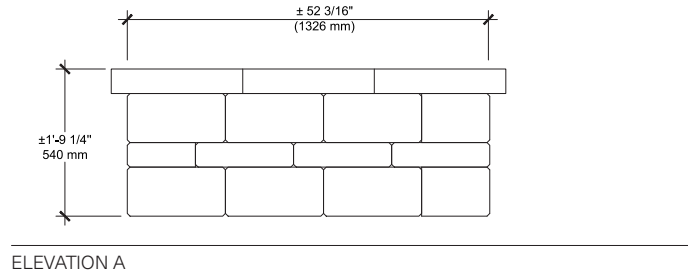
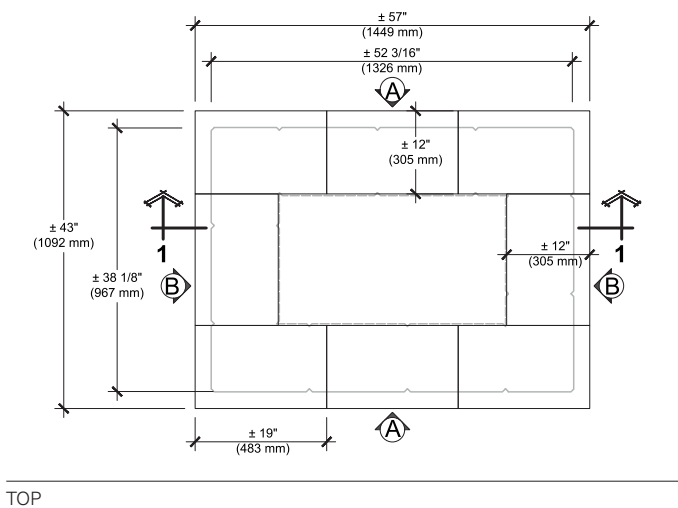

- A. STEEL BOX INSERT
- B. CLEAN STONE  $\frac{3}{4}"$  (20 mm), 4" (100 mm) THICK
- C. RAFFINATO CAP 90 mm (PRE-CUT)
- D. RAFFINATO 180 mm CORNER BLOCK
- E. RAFFINATO 90 mm CORNER BLOCK
- F. TECHO-BLOC PAVERS OR SLABS
- G. SETTING BED 1" (25 mm)
- H. COMPACTED GRANULAR BASE 0- $\frac{3}{4}"$  (0-20 mm)

### QUANTITY OF MATERIALS REQUIRED

- Raffinato cap 90 mm: **8**
- Raffinato 90 mm corner block: **10**
- Raffinato 180 mm corner block: **20**

**NOTE:** Secure the blocks using a heat resistant concrete adhesive. The installer must ensure that the installation and use of the firepit comply with local regulations and code requirements.

Consult our Installation Guide in our website for a detail step by step installation.

# D

TECHO-BLOC WARRANTY APPLIES TO BRANDON STONES. THE WARRANTY DOES NOT APPLY TO ACCESSORY KIT.

## VALENCIA

DESCRIPTION: Fire pit TEXTURE: Split Face

### Pallet Overview

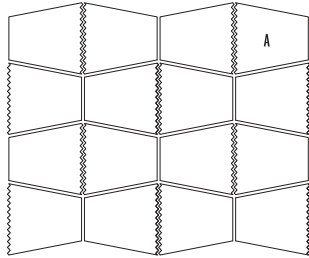

Split Face Chestnut Brown  
Split Face Champlain Grey  
Split Face Shale Grey

### Specifications per pallet



80 units / pallet

	Imperial	Metric
Product dimension (L x W x H)	9 3/4 x 9 13/16 x 2 15/16	247 x 250 x 75
Cubing	80 units	80 units
Approx. Weight	1 557 lbs	706 kg
Height	14 3/4 in	375 mm
Exterior Diameter	48 15/16 in	1 243 mm
Interior Diameter	29 1/8 in	740 mm
Number of rows	5	

### Options and accessories (sold separately)

#### Sleeve Insert

#### Wood Firepit

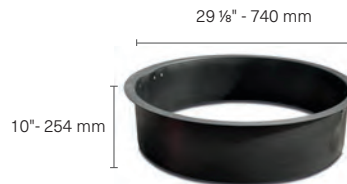

#### Smokeless Insert

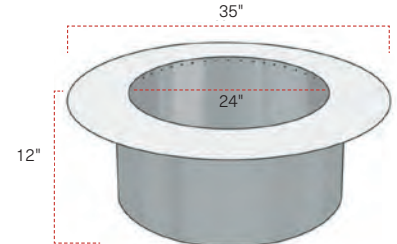

### HPC BURNERS AND BREEO ACCESSORIES (SOLD SEPARATELY)

#### HPC BURNERS

##### FEATURES:

Natural Gas or Liquid Propane  
Standard BTU: 65K  
Push button ignition

##### INCLUDES:

Stainless steel burner with aluminum pan, mounting brackets, Dante valve with push-button ignition, vents, lava rock and stainless steel cover.  
See page 127 for details.

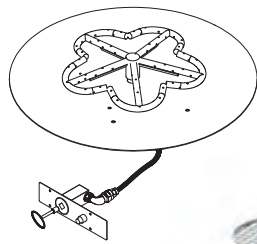

#### GRILLING SYSTEM OUTPOST™

Only for Smokeless inserts

Transforms fire pit into wood-fired grill.  
Weight: 12 lbs. 9 oz.  
Diameter: 22 inches  
See page 128 for details.



### NOTES

See page 6 for icons description.

Available with UGO (Universal Gas Orifice) for natural gas & liquid propane burning options, wood burning or smokeless wood burning.

A Spark screen should always cover the fire bowl when the fireplace is in use.

**Caps are sold separately**

Insert sold separately. Techo-Bloc is not responsible for any damages to the firepit if it is not installed with a sleeve or accessory kit. The firepit is not designed for large fires. Fire should be contained at least 6" away from the firepit wall blocks. Overheating could lead to heat

**OPTIONS AND ACCESSORIES are SOLD SEPARATELY.**

See page 126 for details.

# INSTALLATION GUIDE

## VALENCIA FIRE PIT (KIT)

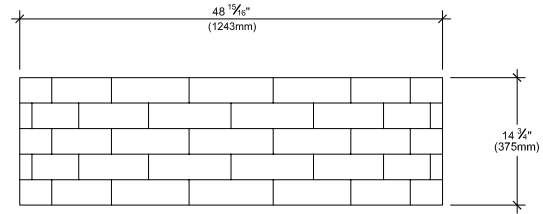
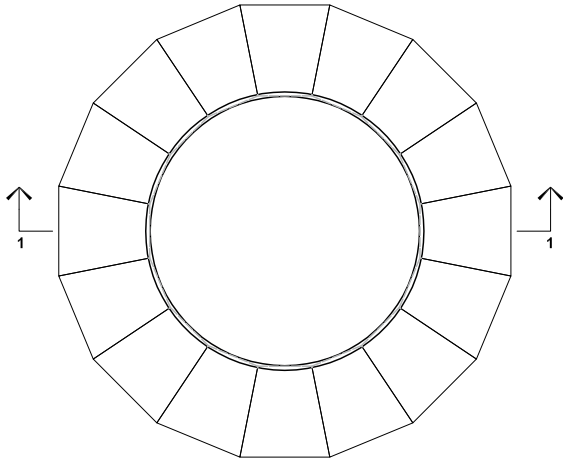

ELEVATION A

TOP VIEW

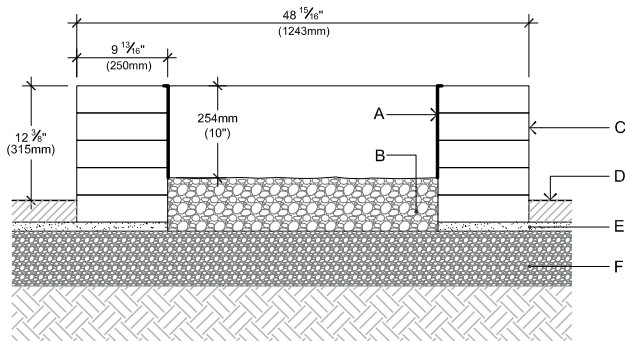

SECTION 1-1

- A. STEEL BOX INSERT
- B. CLEAN STONE 3/4" (20 mm), 6" (150 mm) THICK
- C. VALENCIA BLOCK
- D. TECO-BLOC PAVERS OR SLABS
- E. SETTING BED 1" (25 mm)
- F. COMPACTED GRANULAR BASE 0-3/4" (0-20 mm)

### QUANTITY OF MATERIALS REQUIRED

- Valencia block: **80**

**NOTE:** Secure the blocks using a heat resistant concrete adhesive. The installer must ensure that the installation and use of the fire pit comply with local regulations and code requirements.

Consult our Installation Guide in our website for a detail step by step installation.

## HPC BURNERS FOR FIRE PITS

### DESCRIPTION

Made for outdoor gas fire pits (natural or propane), the patented design of the Torpedo™ burner by HPC delivers the biggest CSA-certified flame on the market. Made of welded commercial-grade stainless steel, this burner seamlessly blends into any fire pit design.

### WHAT COMES IN THE HPC BURNER BOX?

**Valencia units:** burner and connection valve, accessories, owners manual, spark igniter kit, vent covers, key valve bracket, 5 install collars and a cover, 65k orifice installed, 150k orifice loose.

**Prescott units:** burner and connection valve, accessories, owners manual, spark igniter kit, vent covers, key valve bracket, 4 install collars and a cover, 65k orifice installed, 150k orifice loose.

**Brandon units:** burner and connection valve, accessories, owners manual, spark igniter kit, vent covers, key valve bracket, 4 install collars and a cover, 65k orifice installed, 150k orifice loose.

**Raffinato units:** burner and connection valve, accessories, owners manual, spark igniter kit, vent covers, key valve bracket, 4 install collars and a cover 65k orifice installed, 150k orifice loose.

The burner and connection valve come as one part connected. Install collars go around the perimeter of the fire pit.

**Lumi Bowl and Sculptura Collection:** burner and connection valve, accessories, owners manual, key valve bracket, a vinyl cover, 65k orifice installed, 150k orifice loose.

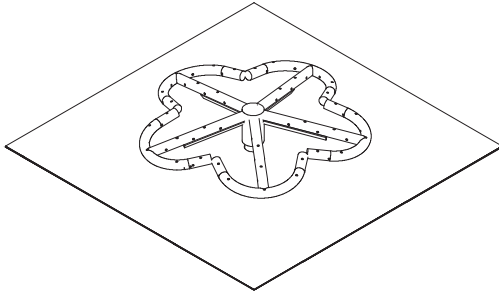

HPC SQUARE - Compatible with Brandon Square, Prescott and Sculptura Collection (burner pan size as per product)

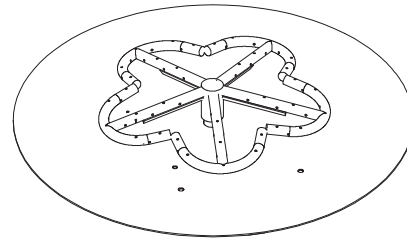

HPC ROUND - Compatible with Lumi, Sculptura Collection and Valencia (burner pan size as per product)

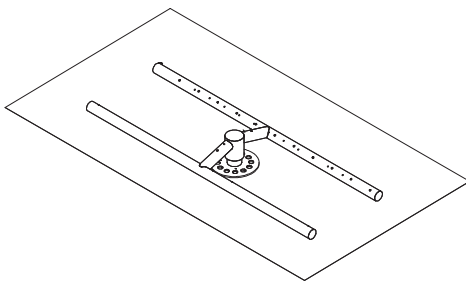

HPC RECTANGLE - Compatible with Brandon Rectangle, Raffinato and Sculptura Collection (burner pan size as per product)

## BREEO SMOKELESS INSERTS

### DESCRIPTION

If you enjoy spending nights by a woodburning fire but aren't a fan of the smoke, the Zentro smokeless insert by Breeo was made for you. Designed to provide more oxygen, this insert allows for a hotter fire that burns its own smoke before it has a chance to escape the fire pit. Say goodbye to teary eyes and coughs, and hello to a great night with friends and family.

### PRODUCT DETAILS:

#### Size: 24"

Circular version compatible with:  
Valencia Circle Fire Pit

Square version compatible with:  
Brandon Square Fire Pit  
Prescott Square Fire Pit

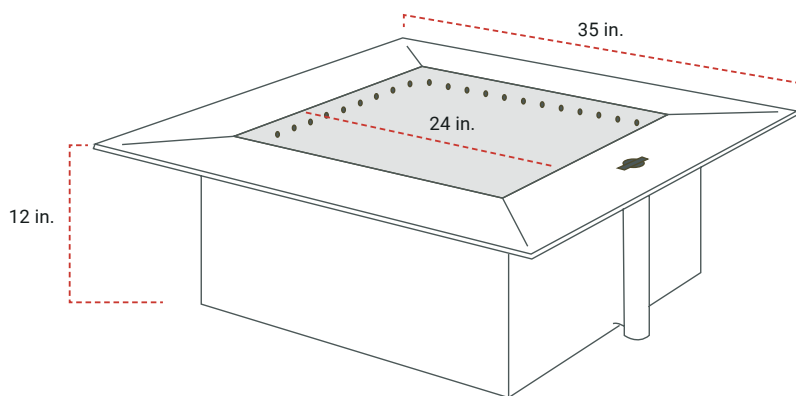

BREEO SQUARE

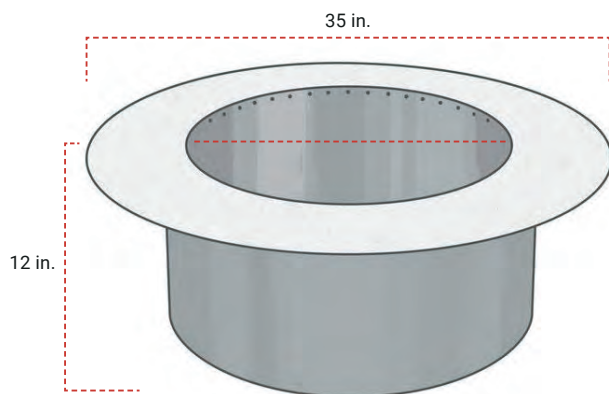

BREEO ROUND 24"

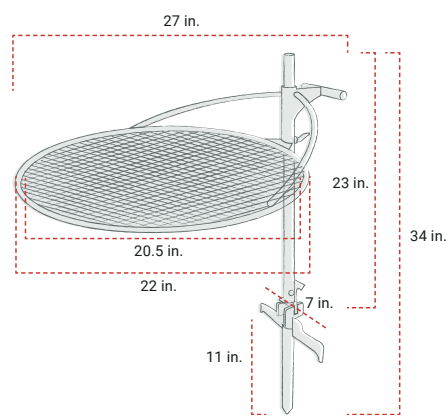

BREEO OUTPOST

### MATERIAL:

#### Outpost™ Grill:

Stainless Steel  
Solid Stainless Post

#### Anchorpoint™ System:

Stainless Steel

### DIMENSIONS:

#### Outpost™ Grill:

Grill Total Width: 22 in.  
Grill Space Width: 20.5 in.  
Post Height: 23"  
(Exposed above Anchorpoint)

Post Total Height: 28.5 in.  
(Inserts into Anchorpoint)

Max Height of Grill: 19 in.  
(Top of Anchorpoint to Bottom of Grill)

### MATERIAL:

Zentro: Black Painted Steel

Weight: 113 lbs.

### DIMENSIONS:

Inside Diameter of Bowl: 24 in.

Outside Diameter of Rim: 35 in.

Total Height: 12 in.

### MATERIAL:

Zentro: Black Painted Steel

Weight: 104 lbs.

### DIMENSIONS:

Inside Diameter of Bowl: 24 in.

Outside Diameter of Rim: 35 in.

Total Height: 12 in.

### Anchorpoint™ System:

Anchorpoint Width: 7 in.

Anchorpoint Height: 11 in.

### Overall

Total Width: 27 in.

Total Height: 34 in.

Total Weight: 12 lbs. 9 oz.

### Max Weight with Outpost™

#### Grill and Kettle Hook X24

X Series 19: 20 lbs.

X Series 24: 40 lbs.

X Series 30: 70 lbs.

(Weight limits with weight oriented 180 degrees opposite the pit)

# EDGES

EDGES & BORDERS



Avignon  
Borealis  
Brandon  
Pietra

P. 133  
P. 134  
P. 135  
P. 136

Raffinato 90 mm  
Raffinato 180 mm  
Röcka

P. 137  
P. 138  
P. 139

# INSTALLATION GUIDE

## INTERLOCKING CONCRETE PAVEMENT

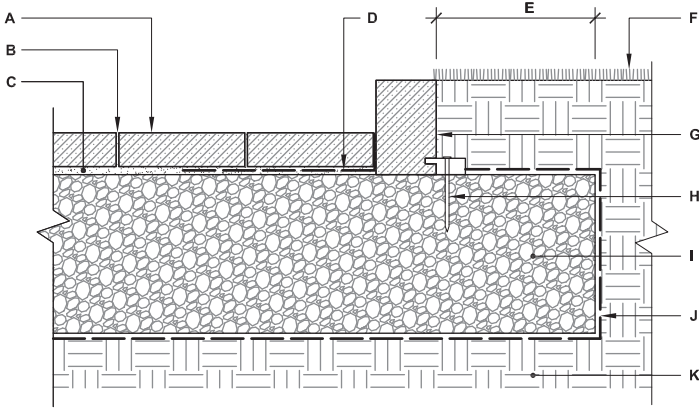

- A. TECHO-BLOC PRECAST CONCRETE PAVER 2 3/8" (60 mm) THICK MIN.
- B. FLEXLOCK POLYMERIC SAND JOINT
- C. SAND SETTING BED (CONCRETE SAND) 1" (25 mm)
- D. GEOTEXTILE 12" (300 mm) WIDE
- E. EXTRA WIDTH EQUAL TO FOUNDATION THICKNESS
- F. LAWN
- G. TECHO-BLOC AVIGNON EDGE
- H. NAIL
- I. COMPACTED GRANULAR BASE 0-3/4" (0-20 mm)
- J. GEOTEXTILE
- K. SUBGRADE

TYPICAL PAVER CROSS SECTION WITH AVIGNON EDGE

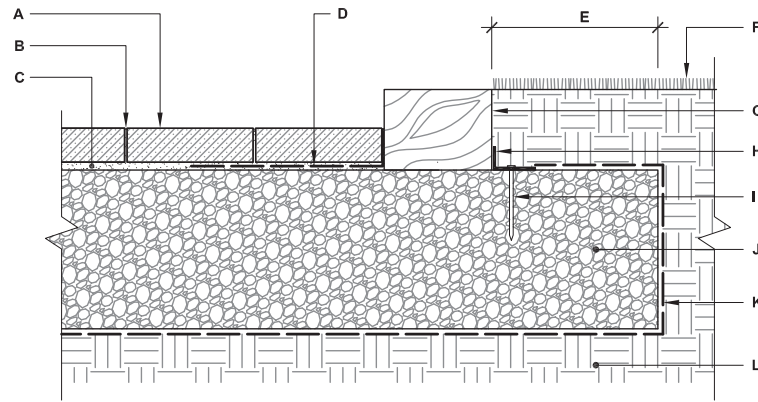

- A. TECHO-BLOC PRECAST CONCRETE PAVER 2 3/8" (60 mm) THICK MIN.
- B. FLEXLOCK POLYMERIC SAND JOINT
- C. SAND SETTING BED (CONCRETE SAND) 1" (25 mm)
- D. GEOTEXTILE 12" (300 mm) WIDE
- E. EXTRA WIDTH EQUAL TO FOUNDATION THICKNESS
- F. LAWN
- G. TECHO-BLOC BOREALIS EDGE
- H. PLASTIC EDGE
- I. NAIL
- J. COMPACTED GRANULAR BASE 0-3/4" (0-20 mm)
- K. GEOTEXTILE
- L. SUBGRADE

TYPICAL PAVER CROSS SECTION WITH BOREALIS EDGE

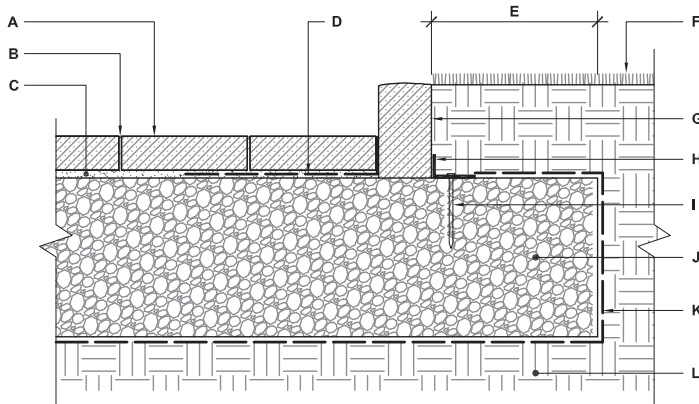

- A. TECHO-BLOC PRECAST CONCRETE PAVER 2 3/8" (60 mm) THICK MIN.
- B. FLEXLOCK POLYMERIC SAND JOINT
- C. SAND SETTING BED (CONCRETE SAND) 1" (25 mm)
- D. GEOTEXTILE 12" (300 mm) WIDE
- E. EXTRA WIDTH EQUAL TO FOUNDATION THICKNESS
- F. LAWN
- G. TECHO-BLOC BRANDON EDGE
- H. PLASTIC EDGE
- I. NAIL
- J. COMPACTED GRANULAR BASE 0-3/4" (0-20 mm)
- K. GEOTEXTILE
- L. SUBGRADE

TYPICAL PAVER CROSS SECTION WITH BRANDON EDGE

# INSTALLATION GUIDE

## INTERLOCKING CONCRETE PAVEMENT

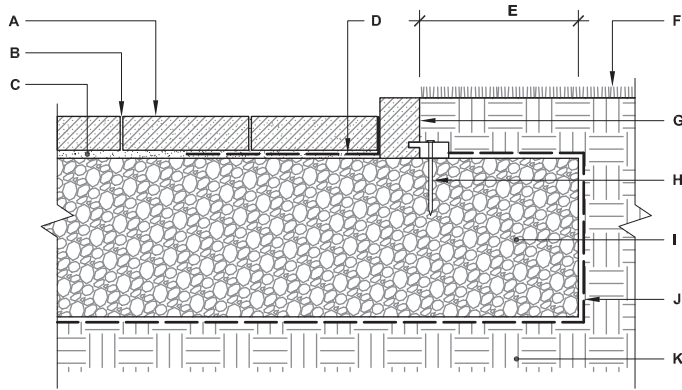

TYPICAL PAVER CROSS SECTION WITH PIETRA EDGE

- A. TECHO-BLOC PRECAST CONCRETE PAVER 2 3/8" (60 mm) THICK MIN.
- B. FLEXLOCK POLYMERIC SAND JOINT
- C. SAND SETTING BED (CONCRETE SAND) 1" (25 mm)
- D. GEOTEXTILE 12" (300 mm) WIDE
- E. EXTRA WIDTH EQUAL TO FOUNDATION THICKNESS
- F. LAWN
- G. TECHO-BLOC PIETRA EDGE
- H. NAIL
- I. COMPACTED GRANULAR BASE 0-3/4" (0-20 mm)
- J. GEOTEXTILE
- K. SUBGRADE

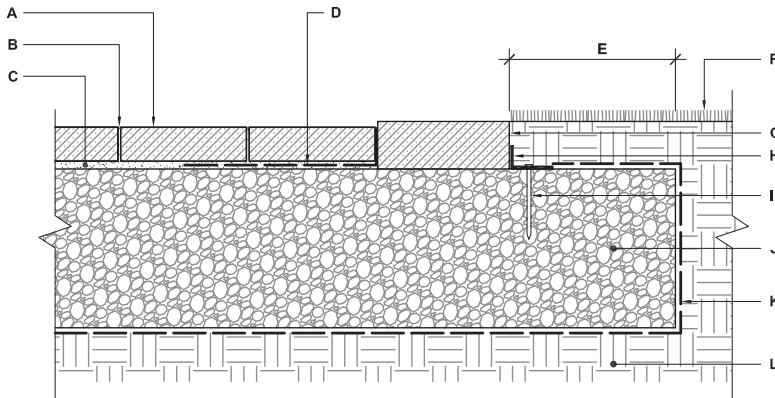

TYPICAL PAVER CROSS SECTION WITH RAFFINATO 90 MM EDGE

- A. TECHO-BLOC PRECAST CONCRETE PAVER 2 3/8" (60 mm) THICK MIN.
- B. FLEXLOCK POLYMERIC SAND JOINT
- C. SAND SETTING BED (CONCRETE SAND) 1" (25 mm)
- D. GEOTEXTILE 12" (300 mm) WIDE
- E. EXTRA WIDTH EQUAL TO FOUNDATION THICKNESS
- F. LAWN
- G. TECHO-BLOC RAFFINATO 90 mm EDGE
- H. PLASTIC EDGE
- I. NAIL
- J. COMPACTED GRANULAR BASE 0-3/4" (0-20 mm)
- K. GEOTEXTILE
- L. SUBGRADE

# INSTALLATION GUIDE

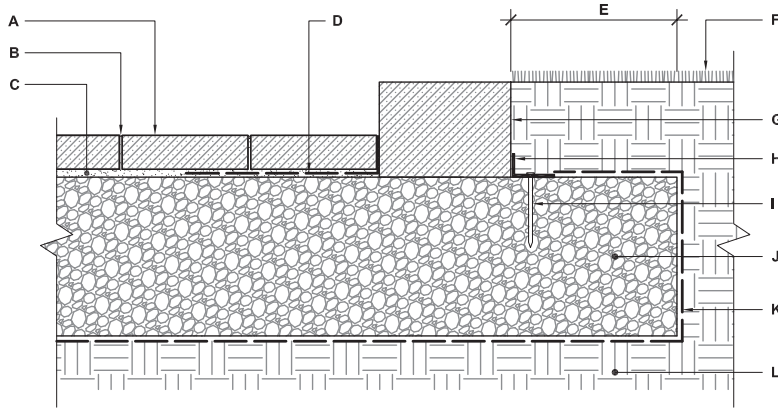

- A. TECHO-BLOC PRECAST CONCRETE PAVER 2 3/8" (60 mm) THICK MIN.
- B. FLEXLOCK POLYMERIC SAND JOINT
- C. SAND SETTING BED (CONCRETE SAND) 1" (25 mm)
- D. GEOTEXTILE 12" (300 mm) WIDE
- E. EXTRA WIDTH EQUAL TO FOUNDATION THICKNESS
- F. LAWN
- G. TECHO-BLOC RAFFINATO 180 mm EDGE
- H. PLASTIC EDGE
- I. NAIL
- J. COMPACTED GRANULAR BASE 0-3/4" (0-20 mm)
- K. GEOTEXTILE
- L. SUBGRADE

TYPICAL PAVER CROSS SECTION WITH RAFFINATO 180 MM EDGE

# INTERLOCKING CONCRETE PAVEMENT

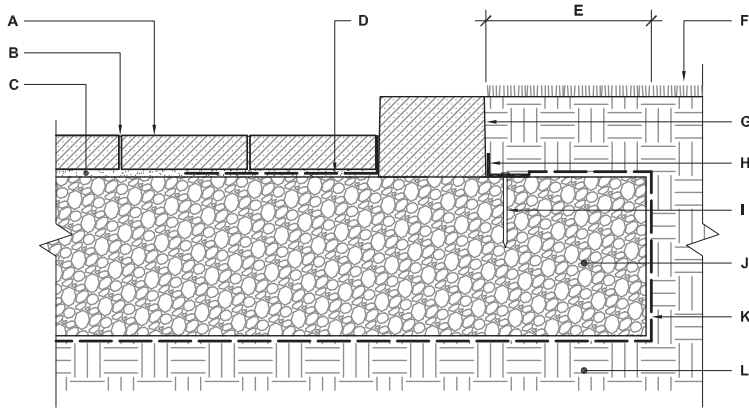

- A. TECHO-BLOC PRECAST CONCRETE PAVER 2 3/8" (60 mm) THICK MIN.
- B. FLEXLOCK POLYMERIC SAND JOINT
- C. SAND SETTING BED (CONCRETE SAND) 1" (25 mm)
- D. GEOTEXTILE 12" (300 mm) WIDE
- E. EXTRA WIDTH EQUAL TO FOUNDATION THICKNESS
- F. LAWN
- G. TECHO-BLOC RÖCKA EDGE
- H. PLASTIC EDGE
- I. NAIL
- J. COMPACTED GRANULAR BASE 0-3/4" (0-20 mm)
- K. GEOTEXTILE
- L. SUBGRADE

TYPICAL PAVER CROSS SECTION WITH RÖCKA EDGE

D ❄️

# AVIGNON

**DESCRIPTION:** Edge **TEXTURE\*:** Chiseled top and one sculpted side / Split Face

**Pallet Overview**

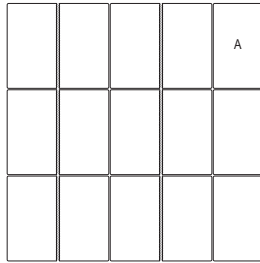

**Specifications per pallet**



	Imperial	Metric
Product dimension (L x W x H)	12 x 4 1/2 x 7	305 x 114 x 178
Linear coverage per pallet	90 lin. ft	27.44 lin. m
Weight	2 785 lbs	1 263 kg
Number of rows	6	
Lin. coverage per row	15 lin. ft	4.57 lin. m



Chiseled / Split Face\*  
Chestnut Brown

Chiseled / Split Face\*  
Champlain Grey

Chiseled / Split Face\*  
Shale Grey

**Plastic Edge Restraint System.**

(Nail is not included)

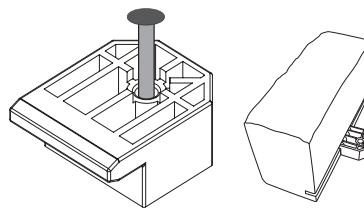

**NOTES**

The Avignon and Pietra edges come with a plastic edge restraint system that can receive an 8" or 10" (200 mm or 250 mm) nail.

The edge restraint is easily inserted in the back groove of the block and secures the block in place with the use of an 8" or 10" (200 mm or 250 mm) nail. Nail is not included.

See page 6 for icons description.

See 130 for more technical information.

\*This product is undergoing a texture update: from Chiseled to Split Face. Chiseled units will be available while supplies last.



# BOREALIS

DESCRIPTION: Edge TEXTURE: Wood

Specifications per pallet	Imperial	Metric
 Dimension Front (L x D x H)	48 x 7 3/4 x 6	1 219 x 197 x 152
Dimension Back (L x D x H)	48 x 8 x 6	1 219 x 203 x 152
Linear coverage per pallet	64 lin. ft	19.51 lin. m
Weight	3 042 lbs	1 380 kg
Number of rows	4	
Lin. coverage per row	16 lin. ft	4.88 lin. m

16 units / pallet

Pallet Overview
A

Smoked Pine

Wood



Hazelnut Brandy

Wood



## NOTES

\*For an authentic look, each color option is composed of a variety of darker & lighter tones. Natural ingredients such as granite are present within the recipe to allow for a range in tones, veining and textures from one stone to another.

See page 6 for icons description.  
See 130 for more technical information.



D ❄️

# BRANDON

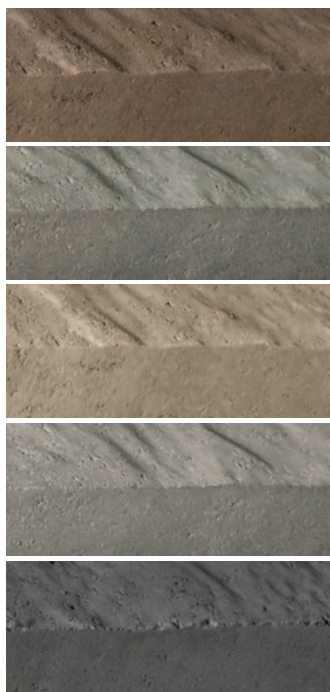
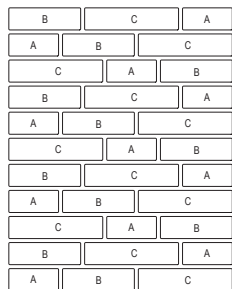

DESCRIPTION: Edge TEXTURE: Slate

### Pallet Overview



Slate Chestnut Brown  
Slate Champlain Grey  
Slate Caffè Crema  
Slate Shale Grey  
Slate Onyx Black

### Specifications per pallet

	Imperial	Metric
<b>A</b>  Product dimension (L x D x H) <b>A</b>	8 7/8 x 3 15/16 x 7 1/16	225 x 100 x 180
<b>B</b>  Product dimension (L x D x H) <b>B</b>	12 3/16 x 3 15/16 x 7 1/16	325 x 100 x 180
<b>C</b>  Product dimension (L x D x H) <b>C</b>	16 3/4 x 3 15/16 x 7 1/16	425 x 100 x 180
44 units / pallet	Linear coverage per pallet	140.75 lin. ft / 42.90 lin. m
44 units / pallet	Weight	3 513 lbs / 1 593 kg
44 units / pallet	Number of rows	4
44 units / pallet	Lin. coverage per row	35.19 lin. ft / 10.73 lin. m



### NOTES

See page 6 for icons description.  
See 130 for more technical information.



# PIETRA

**DESCRIPTION:** Edge **TEXTURE:** Split Face and Aged

Specifications per pallet		Imperial	Metric
<b>A</b> 	Product dimension (L×D×H) <b>A</b>	8 7/8 × 3 1/8 × 4 1/2	225 × 80 × 114
	Product dimension (L×D×H) <b>B</b>	11 1/16 × 3 1/8 × 4 1/2	300 × 80 × 114
32 units / pallet	Product dimension (L×D×H) <b>C</b>	14 3/4 × 3 1/8 × 4 1/2	375 × 80 × 114
<b>B</b> 	Linear coverage per pallet	96 lin. ft	29.20 lin. m
	Weight	1 277 lbs	579 kg
32 units / pallet	Number of rows	4	
<b>C</b> 	Lin. coverage per row	24 lin. ft	7.32 lin. m
	32 units / pallet		

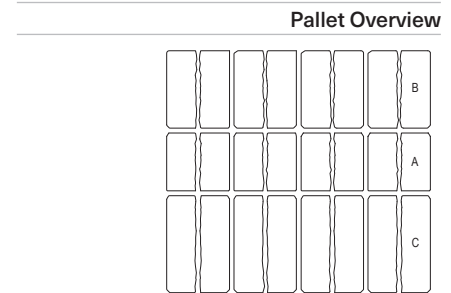

## Plastic Edge Restraint System.

(Nail is not included)

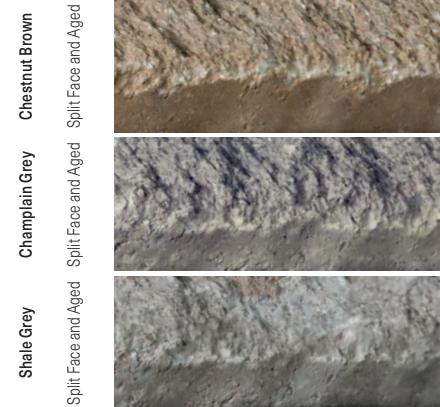
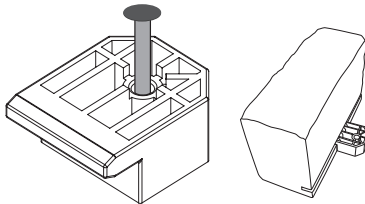

## NOTES

The Avignon and Pietra edges come with a plastic edge restraint system that can receive an 8" or 10" (200 mm or 250 mm) nail.

The edge restraint is easily inserted in the back groove of the block and secures the block in place with the use of an 8" or 10" (200 mm or 250 mm) nail. Nail is not included.

See page 6 for icons description.  
See 131 for more technical information.



# RAFFINATO 90 mm

DESCRIPTION: Edge TEXTURE: Smooth or Polished

## Pallet Overview - 90 mm Smooth

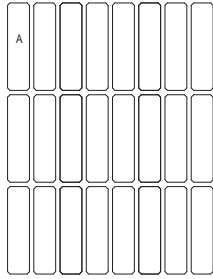

## Pallet Overview - 90 mm Polished

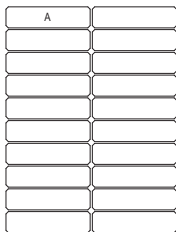

### 90 mm Smooth

#### Specifications per pallet



48 units / pallet

	Imperial	Metric
Product dimension (L x D x H)	14 1/8 x 9 13/16 x 3 9/16	359 x 249 x 90
Linear coverage per pallet	56.5 lin. ft	17.23 lin. m
Weight	1 548 lbs	702 kg
Number of rows	2	
Linear coverage per row	28.27 lin. ft	8.62 lin. m

### 90 mm Polished

#### Specifications per pallet



40 units / pallet

	Imperial	Metric
Product dimension (L x D x H)	14 1/8 x 9 5/8 x 3 9/16	357 x 245 x 90
Linear coverage per pallet	46.9 lin. ft	14.28 lin. m
Weight	1 559 lbs	707 kg
Number of rows	2	
Linear coverage per row	23.43 lin. ft	7.14 lin. m

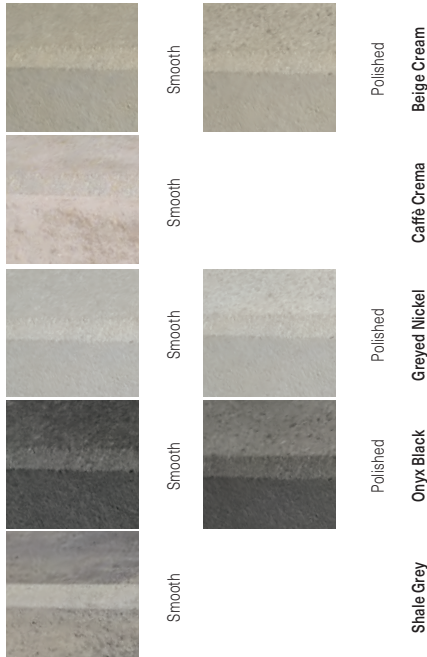

## NOTES

See page 6 for icons description.

See 131 for more technical information.

**Polished is made-to-order, with a minimum order of 500 sq. ft. of Raffinato Polished wall. Deposit required.**



# RAFFINATO 180 mm

DESCRIPTION: Edge TEXTURE: Smooth or Polished

## 180 mm Smooth

### Specifications per pallet



24 units / pallet

	Imperial	Metric
Product dimension (L x D x H)	14 1/8 x 9 1/16 x 7 1/16	359 x 249 x 180
Linear coverage per pallet	28.3 lin. ft	8.62 lin. m
Weight	1 529 lbs	694 kg
Number of rows	2	
Linear coverage per row	14.13 lin. ft	4.31 lin. m

## Pallet Overview - 180 mm Smooth

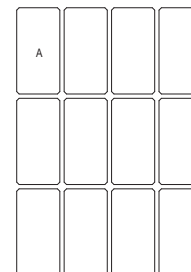

## 180 mm Polished

### Specifications per pallet



20 units / pallet

	Imperial	Metric
Product dimension (L x D x H)	14 1/16 x 9 5/16 x 7 1/16	357 x 245 x 180
Linear coverage per pallet	23.4 lin. ft	7.14 lin. m
Weight	1 557 lbs	706 kg
Number of rows	2	
Linear coverage per row	11.71 lin. ft	3.57 lin. m

## Pallet Overview - 180 mm Polished

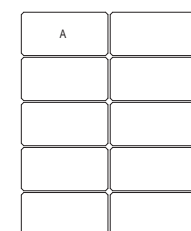

## NOTES

See page 6 for icons description.

See 132 for more technical information.

Polished is made-to-order, with a minimum order of 500 sq. ft. of Raffinato Polished wall. Deposit required.

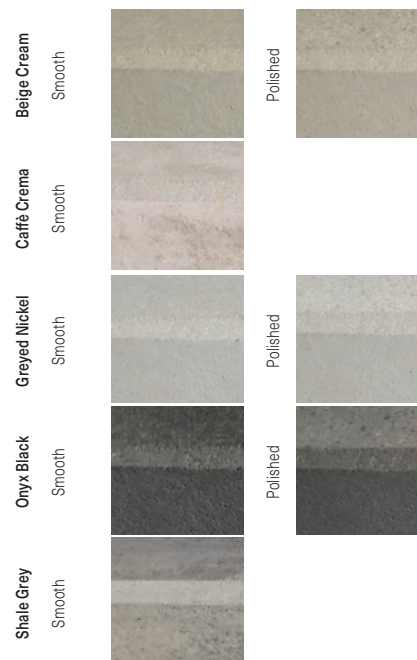



# RÖCKA

DESCRIPTION: Edge TEXTURE: Fossil stone

### Pallet Overview - Row 1

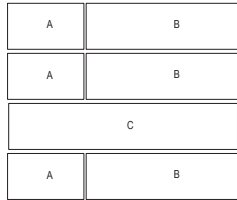



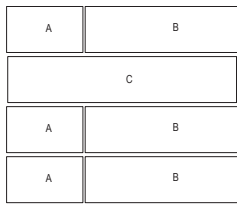

### Pallet Overview - Row 2

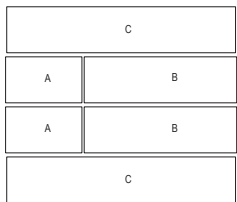

### Pallet Overview - Row 3

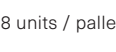

### Specifications per pallet

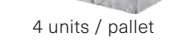
		Imperial	Metric
<b>A</b>	 Dimension Top (LxDxH) <b>A</b>	13 ¼ x 7 ¾ x 6	337 x 197 x 152
	 Dimension Bottom (LxDxH) <b>A</b>	13 ¼ x 8 x 6	337 x 203 x 152
8 units / pallet	 Dimension Top (LxDxH) <b>B</b>	26 ½ x 7 ¾ x 6	673 x 197 x 152
	 Dimension Bottom (LxDxH) <b>B</b>	26 ½ x 8 x 6	673 x 203 x 152
<b>B</b>	 Dimension Top (LxDxH) <b>C</b>	39 ¾ x 7 ¾ x 6	1 010 x 197 x 152
	 Dimension Bottom (LxDxH) <b>C</b>	39 ¾ x 8 x 6	1 010 x 203 x 152
8 units / pallet	Linear coverage per pallet	39.75 lin. ft	12.12 lin. m
<b>C</b>	Weight	1 860 lbs	844 kg
	Number of rows	3	
4 units / pallet	Lin. coverage per row	13.25 lin. ft	4.04 lin. m

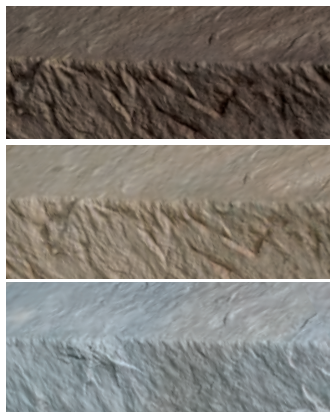

Fossil stone  
Fossil stone  
Fossil stone

Rock Garden Brown  
Riviera  
Chocolate Brown

### NOTES

\*For an authentic look, each color option is composed of a variety of darker & lighter tones. Natural ingredients such as granite are present within the recipe to allow for a range in tones, veining and textures from one stone to another.

See page 6 for icons description.  
See 132 for more technical information.

# WALLS

WALLS, PILLARS & PLANTERS



Borealis	P. 162	Prescott	P. 203
Brandon	P. 165	Raffinato	P. 211
Fascia Wall Collection	P. 176	Röcka	P. 222
Fascia Iconic	P. 177	Sandstone	P. 225
Fascia Rosemont	P. 178	Semma	P. 227
G-Force	P. 183	Skyscraper	P. 233
Graphix	P. 188	Systema	P. 239
Mini-Creta Architectural	P. 192	Travertina Raw	P. 241

## PHYSICAL AND GEOMETRICAL CHARACTERISTICS

CHARACTERISTICS		ASTM C 1372	TECHO-BLOC
Compressive strength		3 000 psi [21 MPa] min.	5 050 psi [35 MPa] min.
Water absorption		13 lb/ft <sup>3</sup> [208 kg/m <sup>3</sup> ] max	9 lb/ft <sup>3</sup> [144 kg/m <sup>3</sup> ] max.
Freeze-thaw durability		Mass loss (max.): 1% at 100 cycles, or Mass loss (max.): 1.5% at 150 cycles	Mass loss (max.): 1% at 100 cycles, or Mass loss (max.): 1.5% at 150 cycles
Dimension tolerance <sup>1</sup>	length	± 1/8" [3.2 mm]	± 1/8" [3.2 mm]
	width	± 1/8" [3.2 mm]	± 1/8" [3.2 mm]
	height	± 1/8" [3.2 mm]	± 1/8" [3.2 mm]

Notes : 1. The dimension tolerance is not applicable to split facings or other architectural finish.

2. The dimensional tolerance for Stonedge wet cast retaining wall units is: ± 3/16" (5 mm) for height and ± 1/2" (13 mm) for length and width.

3. During the installation, the level between adjacent wall units will vary (usually more than for a dry cast wall unit) in order to obtain a more realistic appearance of a natural stone wall. Stonedge collection of wet cast wall units include, but are not limited to, the following: Borealis, Prescott, Röcka and Travertina Raw wall units.

# APPLICATION CHART

PRODUCT	Depth (Nominal)		Batter	Connector Type	Alignment		Retaining Walls						Freestanding Walls	Pillars	Steps	Outdoor Fire Features		
	mm	in.			Straight Wall	Curved Wall	Typical Height Range <sup>(3)</sup>			Gravity		Geogrid Reinforced				PerVIOUS Concrete Backfill	Fire Pit	Grill Island
							Landscaping up to 1.5-4 ft	Misc size up to 8-10 ft	Heavy Duty 10 ft and above	Single Depth	Multi-Depth							
BOREALIS	152	6	0° <sup>(1)(2)</sup>	-	X		X			X			X			X <sup>(6)</sup>	X <sup>(6)</sup>	
BRANDON	250	9 13/16	0°; 4.4° <sup>(1)</sup>	HDPE Vertical Key (Short)	X	X		X		X	X	X	X	X <sup>(4)</sup>	X	X <sup>(6)</sup>	X <sup>(6)</sup>	
FASCIA <sup>(8)</sup>	263	10 3/8	0°; 5.3° <sup>(1)</sup>	HDPE Horizontal Key & Front Lip	X		X		X	X	X	X	X	X	X		X <sup>(6)</sup>	
G-FORCE	290	11 7/8	3.9°	HDPE Vertical Key (Long)	X	X			X	X	X	X		X <sup>(4)</sup>	X	X <sup>(6)</sup>	X <sup>(6)</sup>	
GRAPHIX	205 - 280	8 1/8 - 11	Variable	HDPE Horizontal Key	X			X		X	X	X	X	X	X		X <sup>(6)</sup>	
MINI-CRETA	250	9 13/16	0°; 5.3° <sup>(1)</sup>	HDPE Horizontal Key	X	X		X		X	X	X	X	X <sup>(4)</sup>	X	X <sup>(6)</sup>	X <sup>(6)</sup>	
PRESCOTT	250	9 13/16	0°; 4.5° <sup>(1)</sup>	HDPE Vertical Key (Short)	X	X	X		X	X	X		X	X <sup>(4)</sup>	X	X <sup>(6)</sup>	X <sup>(6)</sup>	
RAFFINATO	249	9 13/16	0°; 4.4° <sup>(1)</sup>	HDPE Vertical Key (Short)	X	X		X		X	X	X	X	X <sup>(4)</sup>	X	X <sup>(6)</sup>	X <sup>(6)</sup>	
RÖCKA	203	8	0° <sup>(1)(2)</sup>	-	X		X		X				X			X <sup>(6)</sup>	X <sup>(6)</sup>	
SEMMA	279	11	0°; 7.6° <sup>(1)</sup>	HDPE Horizontal Key	X	X			X	X	X	X	X	X <sup>(4)</sup>	X	X <sup>(6)</sup>	X <sup>(6)</sup>	
SKYSCRAPER <sup>(9)</sup>	590 - 1220	23 1/4 - 48 1/8	0.8°; 12.7°	Precast Concrete Key	X	X			X	X								
SYSTEMA	254	10	0°; 4.4° <sup>(1)</sup>	HDPE Horizontal Key	X		X		X	X	X	X	X	X	X			
TRAVERTINA RAW	202	7 15/16	0°; 5.2° <sup>(1)</sup>	HDPE Vertical Key (Short)	X		X		X				X	X <sup>(4)</sup>	X		X <sup>(6)</sup>	

<sup>(1)</sup> For 0° degree (vertical) batter retaining walls, it is recommended a slight positive batter achieved by tilting the top surface of the leveling pad from front to back. This will accommodate forward rotation of the wall during or after installation. This can be achieved with linear wall only (no curves, no corners).

<sup>(2)</sup> Alternatively to tilting the leveling pad, an offset of 1/4" (6 mm) min. per row could be used instead.

<sup>(3)</sup> These typical height ranges may require geogrid. Contact our Technical Support for assistance.

<sup>(4)</sup> Available Corner/Pillar units, sold separately.

<sup>(5)</sup> Installation drawing available.

<sup>(6)</sup> Not pre-assembled kits available.

<sup>(7)</sup> Pre-assembled kits available.

<sup>(8)</sup> Fascia Wall product includes Iconic and Rosemont Fascia wall collections.

<sup>(9)</sup> Mechanical installation required.

# INSTALLATION GUIDE

## GRAVITY RETAINING WALL CHARACTERISTICS - RESIDENTIAL

The chart below provides general information for residential garden walls based on optimal conditions (see Note 2 below). Contact our Technical Service department if your project requires a higher wall, conditions are not optimal or for commercial applications.

WALL PRODUCT	MAXIMUM TOTAL HEIGHT (INCLUDING EMBEDMENT) WITHOUT SURCHARGE OR SLOPE												MINIMUM DRAINAGE COLUMN WIDTH		MINIMUM RADIUS	
	INCLINED						VERTICAL									
	ANGLE	SETBACK		HEIGHT		ANGLE	SETBACK		HEIGHT							
	(°)	mm	in.	ROWS	mm	in.	(°)	mm	in.	ROWS	mm	in.				
BOREALIS	-	-	-	-	-	-	0.0	0.0	0	3	457	18	400	16	-	-
BRANDON 90 mm	4.4	7.0	¼	8	720	28	0.0	0.0	0	6	540	21	350	14	2.3	7'-6"
BRANDON 180 mm	4.4	14.0	⅜	4	720	28	0.0	0.0	0	3	540	21	350	14	2.3	7'-6"
FASCIA <sup>(4)</sup>	5.3	14.0	⅜	5	750	30	0.0	0.0	0	4	600	24	350	14	-	-
GRAPHIX	VARIABLE			8	600	24	-	-	-	-	-	-	350	14	-	-
G FORCE	3.9	14.0	⅜	4	813	32	-	-	-	-	-	-	300	12	3.0	9'-10"
MINI-CRETA 3"	5.3	7.0	¼	10	750	30	0.0	0.0	0	8	600	24	350	14	2.1	7'-0"
MINI-CRETA 6"	5.3	14.0	⅜	5	750	30	0.0	0.0	0	4	600	24	350	14	2.1	7'-0"
PRESCOTT 2.25"	4.5	4.5	⅜	14	800	32	0.0	0.0	0	12	686	27	350	14	1.6	5'-2"
PRESCOTT 4.5"	4.5	9.0	⅜	7	800	32	0.0	0.0	0	6	686	27	350	14	1.6	5'-2"
RAFFINATO 90 mm	4.4	7.0	¼	8	720	28	0.0	0.0	0	6	540	21	350	14	2.6	8'-6"
RAFFINATO 180 mm	4.4	14.0	⅜	4	720	28	0.0	0.0	0	3	540	21	350	14	2.6	8'-6"
RÖCKA	-	-	-	-	-	-	0.0	0.0	0	3	457	18	400	16	-	-
SEMMA	7.6	20.0	13/16	6	900	35	0.0	0.0	0	4	600	24	330	13	2.1	7'-0"
SKYSCRAPER	12.7	68.5	2 11/16	SEE SKYSCRAPER DESIGN CHART			0.8	4.5	3/16	SEE SKYSCRAPER DESIGN CHART			300	12	INSIDE CURVE 5.5   18'-0" OUTSIDE CURVE 11.0   36'-1"	
SYSTEMA	4.4	14	⅜	3	540	21	0.0	0.0	0	3	540	21	350	14	-	-
TRAVERTINA RAW	5.2	14.0	⅜	5	762	30	0.0	0.0	0	4	610	24	400	16	-	-

- [1] The total height does not include the cap thickness. The total height measurement refers to the vertical distance between the top of the leveling pad (aggregate base) and the top of the uppermost course.
- [2] The optimal conditions assumed for the development of this chart are the following: (i) The retained soil type is granular with an internal friction angle of 36 degrees; (ii) There is no presence of load applied or slope above the wall; and (iii) An adequate drainage system is provided to the wall system.
- [3] The minimum radius is measured from the center of the circle to the outer face of the wall. It corresponds to the lowest course in an internal curve and to the uppermost course in an external curve.
- [4] Fascia Wall product includes Iconic and Rosemont Fascia wall collections.

# INSTALLATION GUIDE

## SUMMARY OF CHARACTERISTICS

TYPE OF WALL	FREESTANDING WALL						PILLARS				
	MAXIMUM EXPOSED HEIGHT [2,3]		MINIMUM WALL RADIUS [4]				Maximum permissible height [2,3,5]				
			Inside		Outside		Exposed		Total		
	mm	in	mm	in	mm	in	mm	in	mm	in	
BOREALIS	612	24"	-	-	-	-	-	-	-	-	-
BRANDON 90 mm [6]	750	29 7/16"	1538	61"	1788	70"	930	36 1/2"	1080	42 1/2"	
BRANDON 180 mm [6]	750	29 7/16"	1538	61"	1788	70"	930	36 1/2"	1080	42 1/2"	
FASCIA WALL COLLECTION [7]	600	23 1/2"	-	-	-	-	750	29 7/16"	900	35 7/16"	
GRAPHIX	600	23 1/2"	-	-	-	-	1050	41 1/4"	1200	47 1/4"	
G FORCE	-	-	-	-	-	-	1069	42"	1219	48"	
MINI-CRETA 3" [6]	750	29 7/16"	907	36"	1158	46"	1050	41 1/4"	1200	47 1/4"	
MINI-CRETA 6" [6]	750	29 7/16"	907	36"	1158	46"	1050	41 1/4"	1200	47 1/4"	
PRESCOTT 2.25" [6]	650	25 1/2"	863	34"	1114	44"	993	39"	1143	45"	
PRESCOTT 4.5" [6]	650	25 1/2"	863	34"	1114	44"	993	39"	1143	45"	
RAFFINATO 90 mm [6]	750	29 7/16"	2259	89"	2510	99"	930	36 1/2"	1080	42 1/2"	
RAFFINATO 180 mm [6]	750	29 7/16"	2259	89"	2510	99"	930	36 1/2"	1080	42 1/2"	
RÖCKA	612	24"	-	-	-	-	-	-	-	-	
SEMMMA [6]	750	29 7/16"	519	20"	807	32"	1050	41 1/4"	1200	47 1/4"	
SYSTEMA	750	29 7/16"	-	-	-	-	930	36 1/2"	1080	42 1/2"	
TRAVERTINA RAW [6]	612	24"	-	-	-	-	917	36"	1067	42"	

- [1] Vertical Retaining walls are constructed without any face inclination or setback.
- [2] Heights do not include cap thickness.
- [3] - Total Height is the vertical distance measured from the top of the footing (aggregate base) to the top of the uppermost course.  
 - Exposed Height is the vertical distance measured from the finished grade at the bottom of the wall to the top of the uppermost course. It does not include the wall depth below grade (embedment).
- [4] Freestanding Minimum Wall radius based on the shortest tapered unit.
- [5] The maximum height does not necessarily correspond to the amount of blocks in a pallet.
- [6] Pillar units sold separately.
- [7] Fascia Wall product includes Iconic and Rosemont Fascia wall collections.



# COMPATIBILITY CHART

Walls & Pillars	Caps																				
	Architectural cap	Brandon cap	Bullnose	Bullnose Grande	Graphix cap	Limestone	Piedimonte	Piedimonte 28"x28"	Portofino	Raffinato 60 mm	Raffinato 90 mm	Sandstone	Sandstone Bullnose	Sandstone Overlay	Terrazzo	Terrazzo Bullnose	Travertina Raw 14"x28"	York	York 28"x28"	York 32"x32"	
Borealis (does not require a cap)																					
Brandon 90 & 180 mm		x	x	x		x	x		x	x	x	x	x	x	x	x	x	x			
Brandon 90 & 180 mm pillar						x		x		x	x	x					x		x		
Fascia Wall Collection - single-sided	x	x	x	x	x	x	x		x	x	x	x	x	x	x	x	x	x			
Fascia Wall Collection - double-sided									x												
G-Force						x	x	x		x	x	x			x	x	x				
Graphix					x	x	x			x	x	x			x	x	x				
Mini-Creta Collection	x	x	x	x		x	x		x	x	x	x	x	x	x	x	x	x			
Mini-Creta Pillar 24" Collection						x		x		x	x	x					x		x		
Prescott Collection						x	x		x	x	x	x			x	x	x	x	x		
Prescott Pillar Collection						x		x		x	x	x					x		x		
Raffinato Collection				x	x	x	x			x	x	x	x	x	x	x	x	x			
Raffinato Pillar Collection						x		x		x	x	x					x				
Röcka (does not require a cap)																					
Semma	x	x	x		x	x	x		x	x	x	x			x	x	x	x	x		
Semma Pillar						x				x		x					x				x
Skyscraper						x				x	x	x			x	x	x				
Systema				x	x	x	x			x	x	x	x	x	x	x	x	x			
Travertina Raw	x	x	x	x	x	x	x		x	x	x	x	x	x	x	x	x	x	x		
Travertina Raw pillar						x				x	x	x					x		x		

NOTE: The combinations shown in this chart are not exclusive. Other combinations can be possible.

Applications	Caps																									
	Architectural	Bali Travertina Raw	Brandon	Bullnose	Bullnose Grande	Graphix	Limestone	Piedimonte 14"x30"	Piedimonte 28"x28"	Portofino	Raffinato 60 mm	Raffinato 90 mm	Sandstone	Sandstone Bullnose	Sandstone Overlay	Terrazzo	Terrazzo Bullnose	Travertina Raw 14"x28"	York wall caps 16", 32", 48"	York 14"x48"	York 24"x36"	York 28"x28"	York 32"x32"	Blu 45 mm	Venetian	
Step	x		x	x	x	x	x	x	x	x	x	x	x	x		x	x	x	x	x						
Concrete & step overlay system															x										x	x
Pool coping		x		x	x			x		x	x	x	x	x	x	x	x	x	x							
Wall single-sided	x		x	x	x	x	x	x	x	x	x	x	x	x	x	x	x	x	x	x						
Wall double-sided	x					x	x	x	x	x	x	x						x	x	x						
Counter top								x	x									x								
Pillar								x		x								x					x	x		

# INSTALLATION GUIDE

## RETAINING WALLS

### INSTALLATION OUTLINE

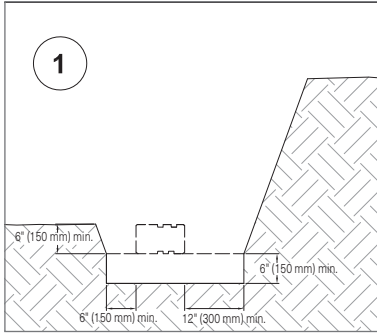

#### 01 EXCAVATION

- Check the location of existing structures and utilities before starting the excavation.
- Dig out a trench. Its depth should be calculated according to the thickness of the leveling pad and the burial depth of the wall.
- Plan for a thickness of at least 6" (150 mm) for the leveling pad and consider that at least 10% of the height of the wall should be buried in the ground. In all cases, the wall must be buried no less than 6" (150 mm) deep.
- In determining the width of the trench, allow for a space of at least 6" (150 mm) at the front of the wall and 12" (300 mm) at the back. Compact and level the excavation base.



#### FOR GEOGRID REINFORCED RETAINING WALLS

The excavation must also take into account the length of geogrid.

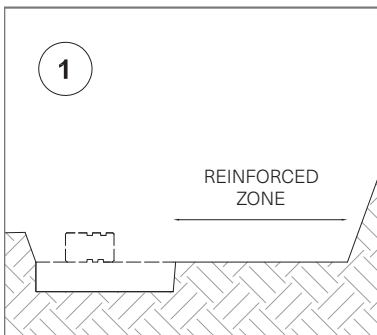

#### 02 FOUNDATION

- Cover the base and back of the trench with a geotextile. Extend the geotextile towards the back of the excavation and eventually above the drainage fill once it is in place close to the top of the wall.
- Next, spread the 0-3/4" (0-20 mm) stone in the trench and compact using a vibratory plate or jumping jack, ensuring that the surface is level. The compacted leveling pad must be at least 6" (150 mm) thick.

#### NOTE FOR STEPPED FOUNDATION

A wall built on an incline requires stepped foundations. For steep inclines, several steps may be required. Construction should start at the lowest level. Each of the steps must follow a level horizontal path and the vertical distance separating the successive steps must equal the height of a block.

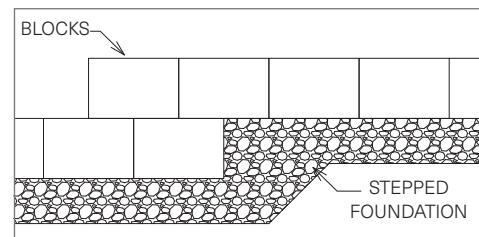
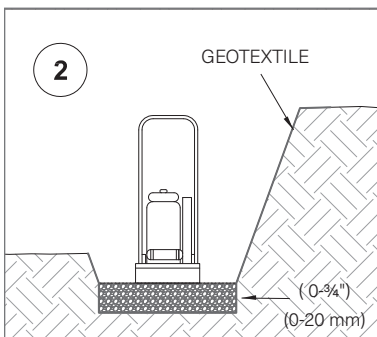

# INSTALLATION GUIDE

## RETAINING WALLS

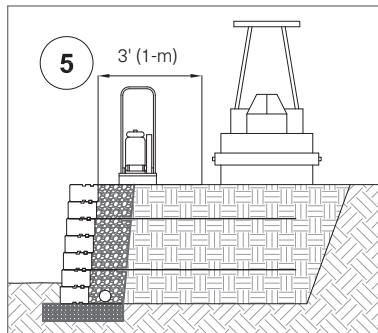
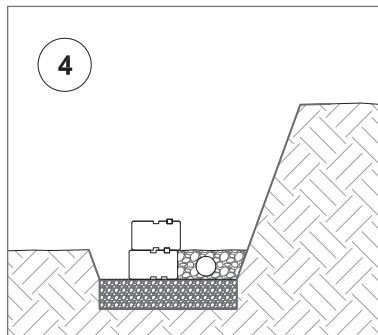
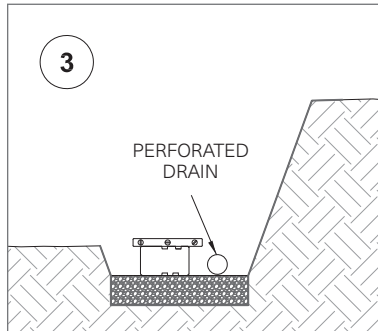

### 03 BUILDING THE FIRST COURSE

- Using blocks of the same height, place the first course on the compacted leveling pad according to the predetermined layout. Check the alignment and leveling in all directions and make sure that all the blocks are in full contact with the leveling pad and properly supported.
- Place the exposed surfaces of the blocks side by side. There must be no space between the exposed faces of adjacent blocks.
- At the back of the wall and on the compacted leveling pad, lay a 4" (100 mm) diameter perforated drain. Connect this drain to the existing drainage system so that it clears the water accumulated behind the wall.

### 04 BACKFILLING

Backfill at the rear of the wall and the space between the back of the blocks with  $\frac{3}{4}$ " (20 mm) clean stone. Use a minimum of 12" (300 mm) of clean stone behind the wall unit, but not less than a minimum of 24" (600 mm) from the face of the wall. Level and settle the clean stone. Any cavities in the blocks must also be filled with clean stone.

### 05 SUBSEQUENT COURSES

- Clean the top of each block before laying the next course. Depending on the type of block, install the connectors on the extremity of each block.
- Lay the subsequent courses, backfilling at the rear of the wall every 8" (200 mm maximum), using the same method outlined in step 4.
- Make sure the subsequent courses are laid such that the vertical seams are aligned with the blocks below.

### FOR GEOGRID REINFORCED RETAINING WALLS



Where geogrids are to be used, cover the clean stone with a geotextile. Select the geogrid according to the type, level and appropriate length. Position the geogrid according to the main reinforcement direction perpendicular to the wall. The geogrid must be continuous all along its embedment length. Splicing of the geogrid in the main reinforcement direction is not permitted. The geogrid must be installed horizontally over the compacted backfill and the previous course of blocks. Fix the connectors on the geogrid and lay the next course of blocks. Pull on the back of the geogrid and maintain its tension by stakes or pins. Repeat with a new section of geotextile and place the reinforced backfill directly behind the drainage fill. Fill and compact up to the level of the blocks.

Heavy equipment must not be used less than 3' (1-m) behind the blocks.  
Construction equipment must not drive directly over the geogrid.  
Repeat the various installation steps.

### 06 FINISHING

Position the course of coping stones (if applicable) or the final course of blocks to complete the wall. The coping stones or final course of blocks must be fixed to the subjacent blocks using concrete adhesive and there must be no space between the blocks.

# INSTALLATION GUIDE

## RETAINING WALLS

### CAP UNIT - DRIP GROOVE

While optional, drip groove applied to the underside of wall cap units is beneficial to reduce the potential of leaving water marks and stains on the wall surface (retaining or freestanding wall). Rain water will run underneath the cap unit, reach the drip groove and fall directly to the ground, instead of continuing to run underneath the cap and down the wall.

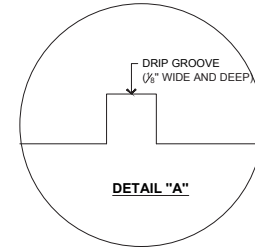
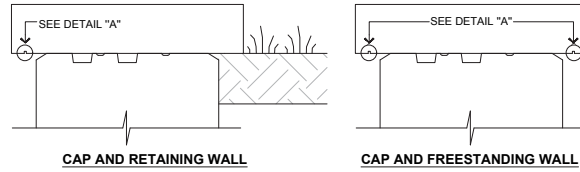

### GRAVITY WALL

Typical cross section

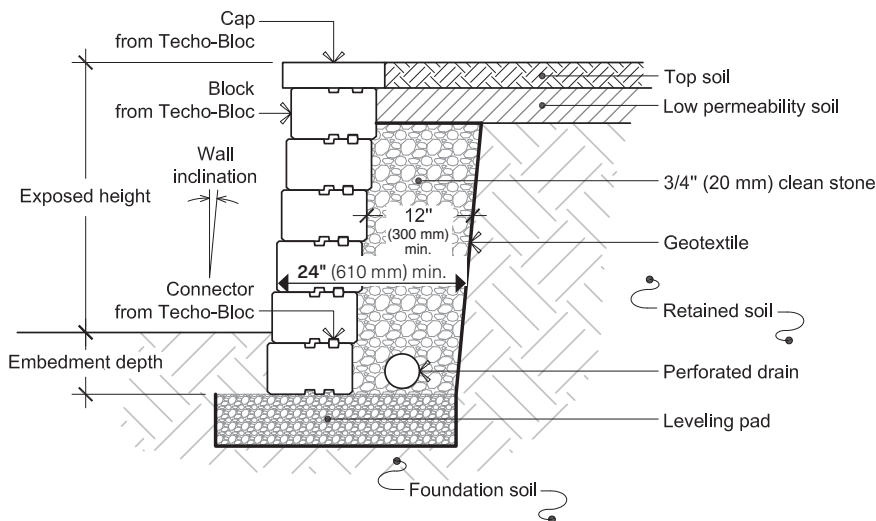

### GEOGRID REINFORCED WALL

Typical cross section

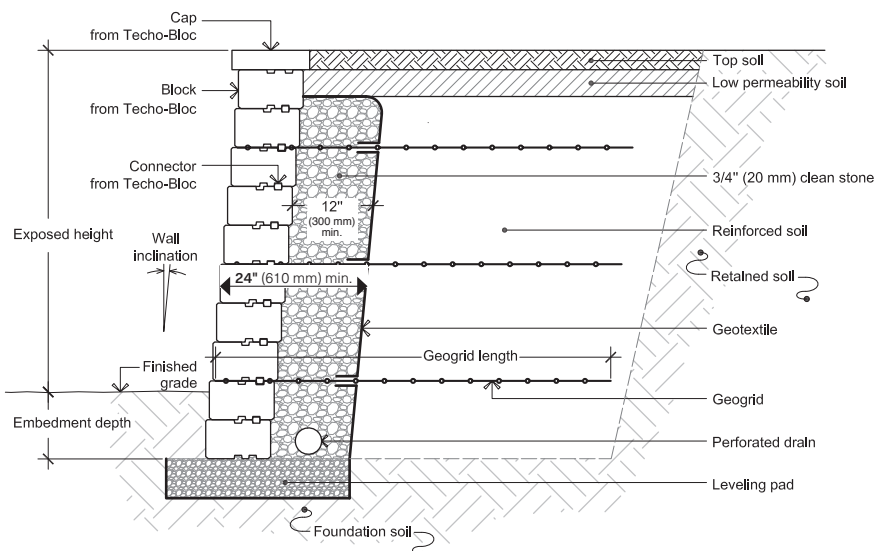

# INSTALLATION GUIDE

## RETAINING WALLS

### ANCHORING SYSTEMS

#### BRANDON 180 mm

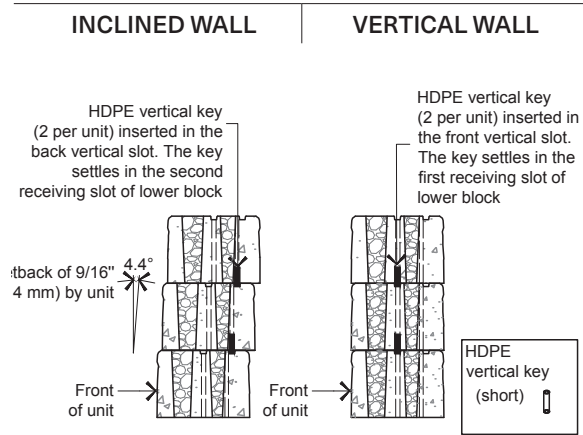

BRANDON 180 mm IS EQUIVALENT TO TWICE THE BRANDON 90 mm

#### FASCIA WALL COLLECTION

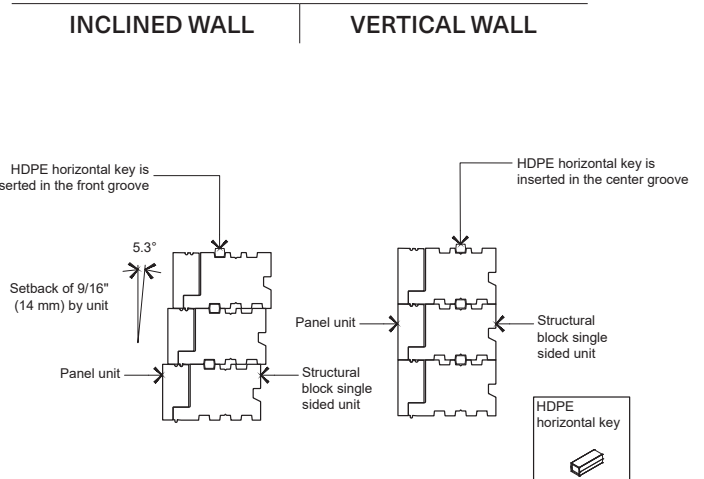

#### G-FORCE

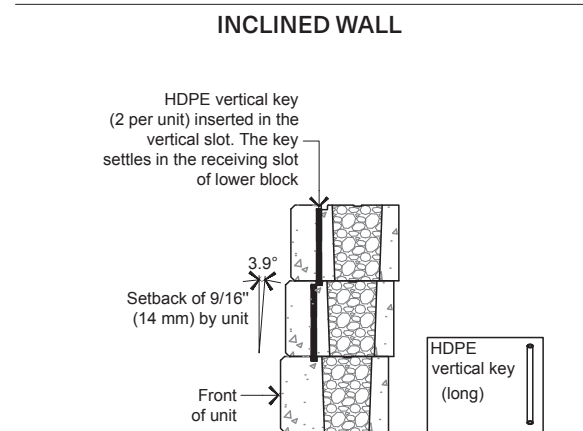

#### GRAPHIX

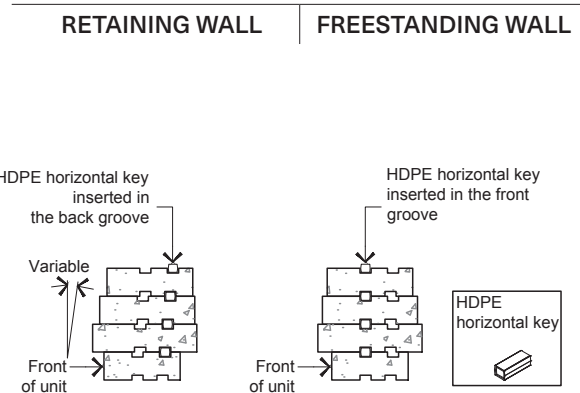

#### MINI-CRETA 6"

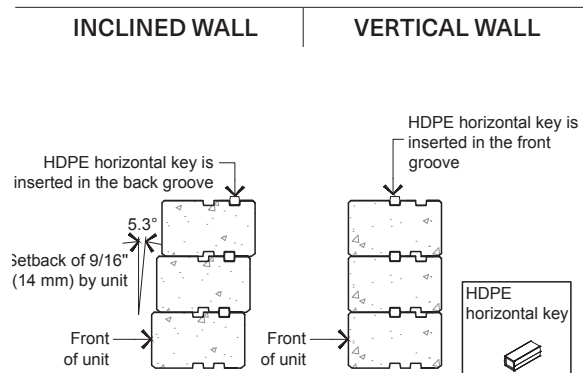

#### PRESCOTT 4.5"

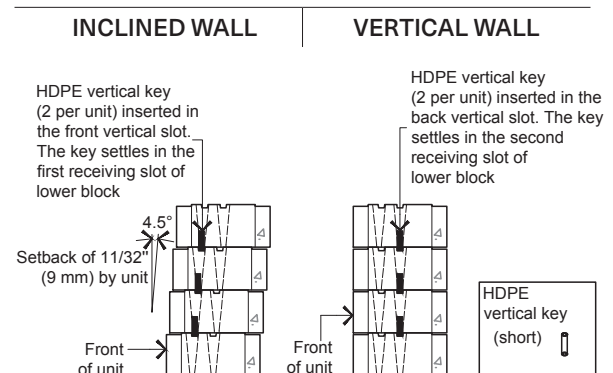

PRESCOTT 4.5" IS EQUIVALENT TO TWICE THE PRESCOTT 2.25"

# INSTALLATION GUIDE

## RETAINING WALLS

### ANCHORING SYSTEMS

#### RAFFINATO 180 mm

INCLINED WALL

VERTICAL WALL

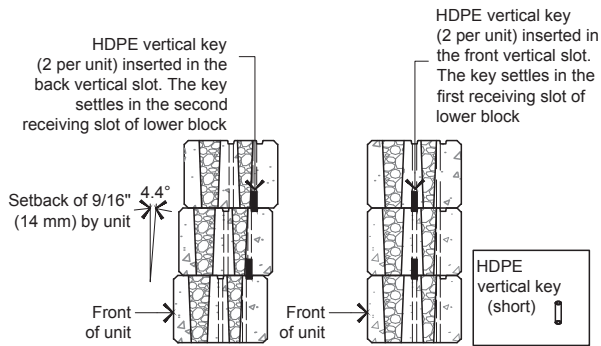

RAFFINATO 180 mm IS EQUIVALENT TO TWICE THE RAFFINATO 90 mm

#### SEMMA

INCLINED WALL

VERTICAL WALL

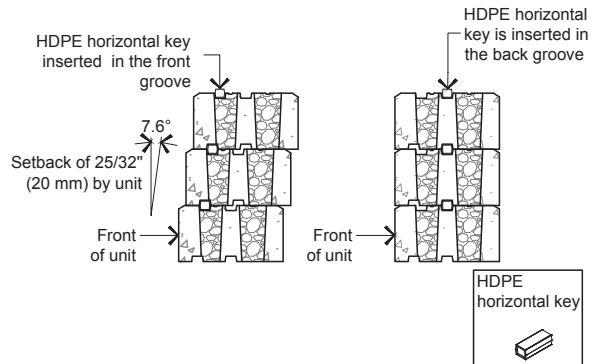

#### SKYSCRAPER

INCLINED WALL

VERTICAL WALL

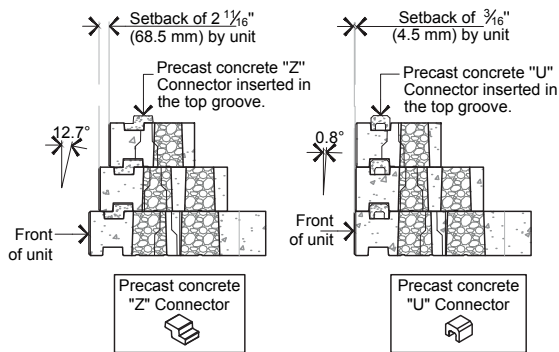

#### SYSTEMA

PATENT PENDING

INCLINED WALL

VERTICAL WALL

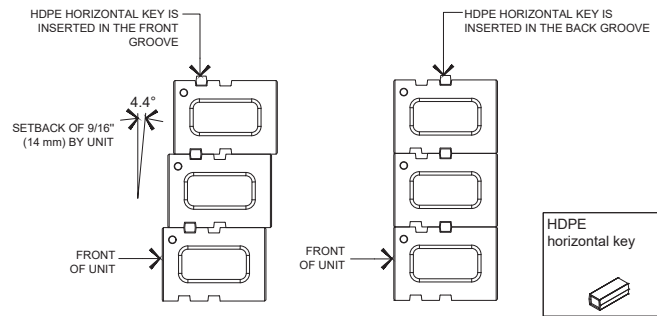

#### TRAVERTINA RAW

INCLINED WALL

VERTICAL WALL

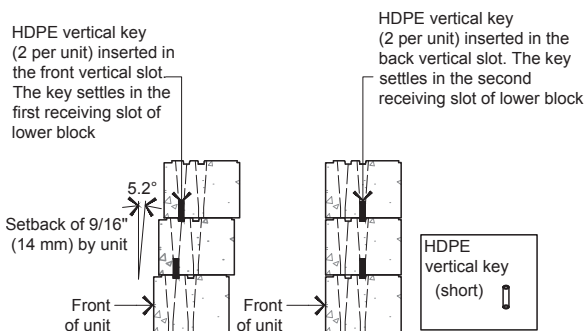

# INSTALLATION GUIDE

## RETAINING WALLS

### ANCHORING SYSTEM | CONNECTORS IN CURVED WALL APPLICATION

---

#### HDPE Horizontal Key

When creating internal curves and the HDPE horizontal keys are in the back groove, two connectors must be installed on each block as illustrated.

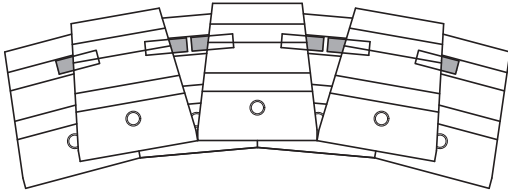

#### HDPE Vertical Key

When creating curves using HDPE vertical keys adjust placement in field to achieve desired curve.

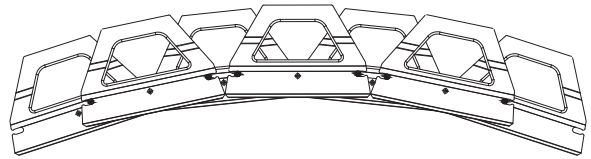

#### Precast concrete "U" Connector

When creating internal curves with the precast concrete "U" connector, place one connector on top center of each lower course block and adjust placement in field to achieve desired curve.

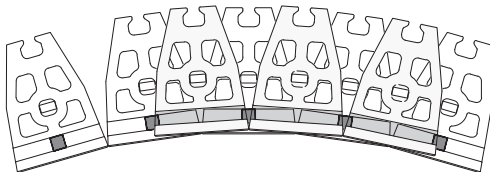

#### Precast concrete "Z" Connector

When creating internal curves with the precast concrete "Z" connector, place one connector on top center of each lower course block and adjust placement in field to achieve desired curve.

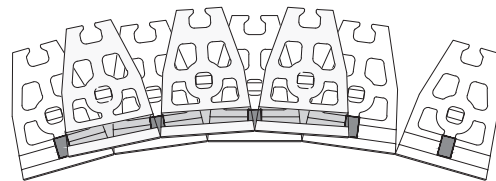

### ANCHORING SYSTEM | CONNECTORS IN GEOGRID REINFORCED WALL APPLICATION

---

#### HDPE Horizontal Key

When installing a geogrid, using HDPE horizontal keys, it must be placed above the connectors. The connectors will therefore be placed before the geogrid. After positioning the geogrid, move the block (from the above course) forward until it touches the connectors and ensures that the system is locked.

# INSTALLATION GUIDE

## RETAINING WALLS

### HDPE Vertical Key

When installing geogrid, using HDPE vertical keys, it must be placed immediately above the lower course block. The connectors will be inserted in the vertical slots of the upper course blocks. Ensure that pin all ways settles into the receiving slot of the lower course block and not on the geogrid. Once the pin settles, move forward the upper block until it touches the connectors and ensures that the system is locked.

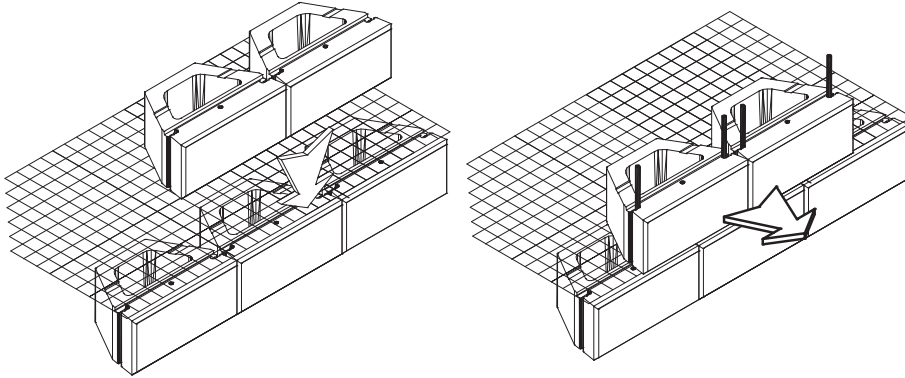

## INTERNAL CORNER

When building a wall with an internal corner, it is recommended to start constructing the wall at the corner and build out from this point in both directions. To form the corner, use the longer modules as illustrated. Build wall B by extending it out from wall A so the end of wall B is aligned with the back of wall A. For subsequent courses, simply alternate the extension of walls A and B.

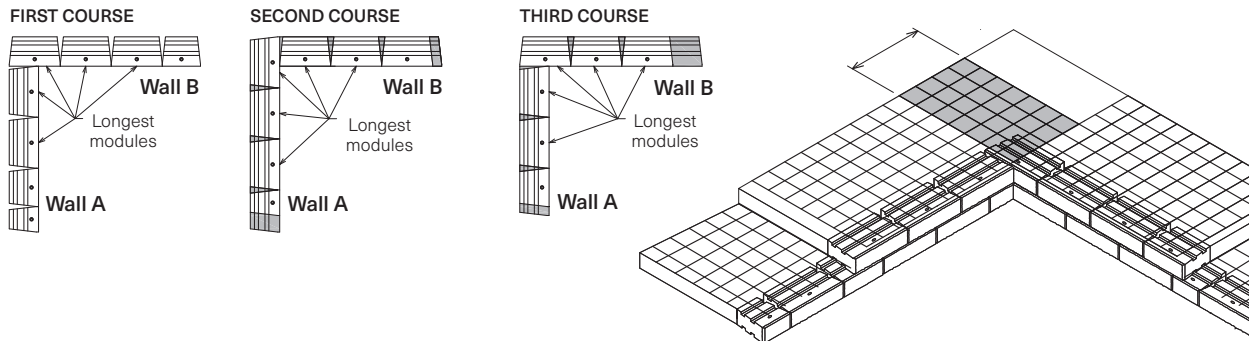

When using geogrid, it must be extended beyond the internal corner by at least 25% of the total height of the wall. Alternate the extension of the geogrid for subsequent layers (as illustrated in grey)

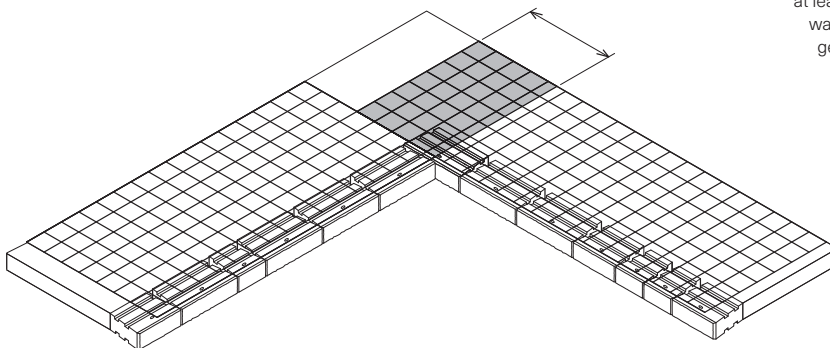

# INSTALLATION GUIDE

## RETAINING WALLS

### EXTERNAL CORNER

For walls with an external corner, start building the wall from the corner and continue from this point in both directions. For each subsequent course, alternate the direction of the corner unit and secure the corner unit to the block below using concrete adhesive.

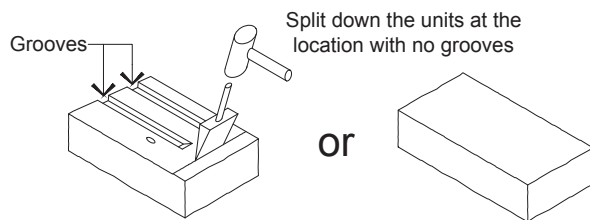
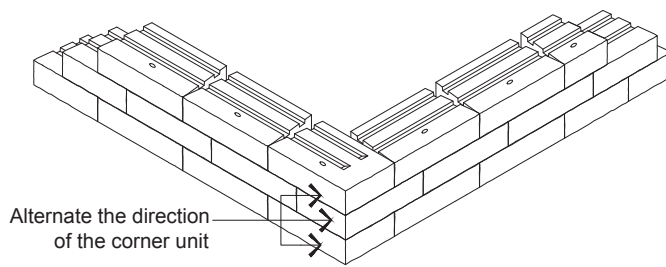

Use corner unit with finish already available on the side

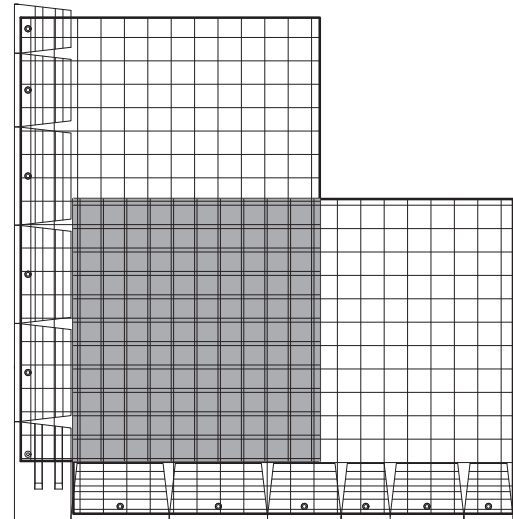

When overlapping two geogrids in the same layer (as illustrated by shaded area) allow at least 3" (75 mm) of backfill in between the

### OBLIQUE CORNER

The longer modules should be used to build an oblique external corner. Alternatively, corner can be replaced by a curve.

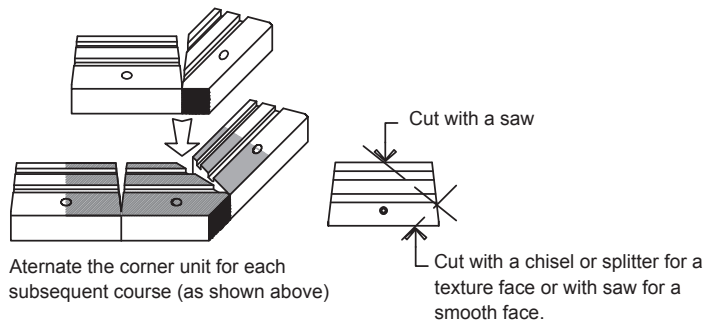
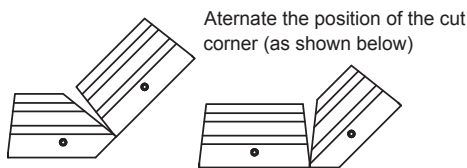

**Note:** Cut face finish may differ from original face finish

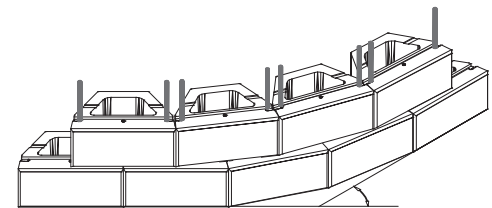
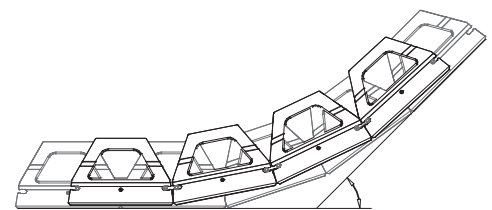

**Note:** Adjust placement in field to achieve desired angle

# INSTALLATION GUIDE

## RETAINING WALLS

### INTERNAL CURVE

The Techo-Bloc retaining wall system allows walls to be built with internal and external curves. These curves can be achieved without cutting the blocks. You will need to angle the curves according to the minimum radius specified by Techo-Bloc.

When building a wall with an internal curve, it is recommended to start building the wall at the center of the curve and place blocks alternately to the left and right of the central block. If the wall to be constructed requires a setback (inclined wall), each course should be offset to the back and the curve will then become bigger. The minimum radius is therefore that of the first course.



When using geogrid, it must cover 100% of the surface around the curve. To do this, additional layers of geogrid are placed on the next course of blocks to fill voids created from previous course (as illustrated in green).

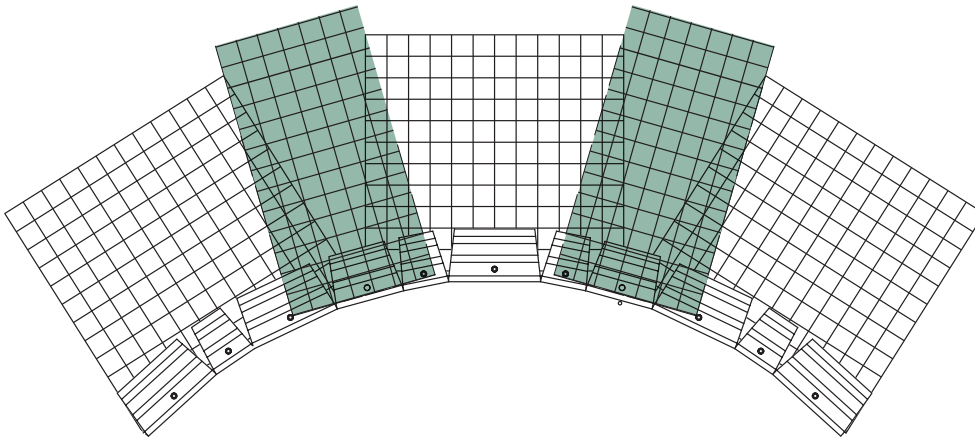

# INSTALLATION GUIDE

## RETAINING WALLS

### EXTERNAL CURVE

When building a wall with an external curve, it is recommended to start building the wall at the center of the curve and place blocks alternately to the left and right of the central block. Unlike internal curves, the external curve gets smaller as courses are added. The minimum radius is therefore that of the last course.

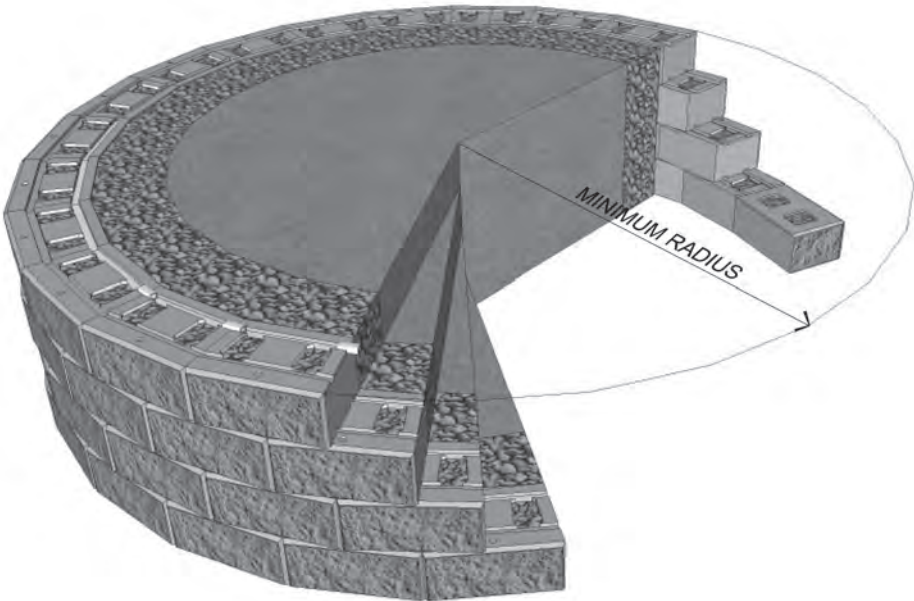

When using geogrid, it must cover 100% of the surface around the curve. To achieve this, additional layers of geogrid are placed on the same course of blocks to fill voids (as illustrated in green). In this case, we recommend at least 3" (75 mm) of backfill in between the overlapping sections.

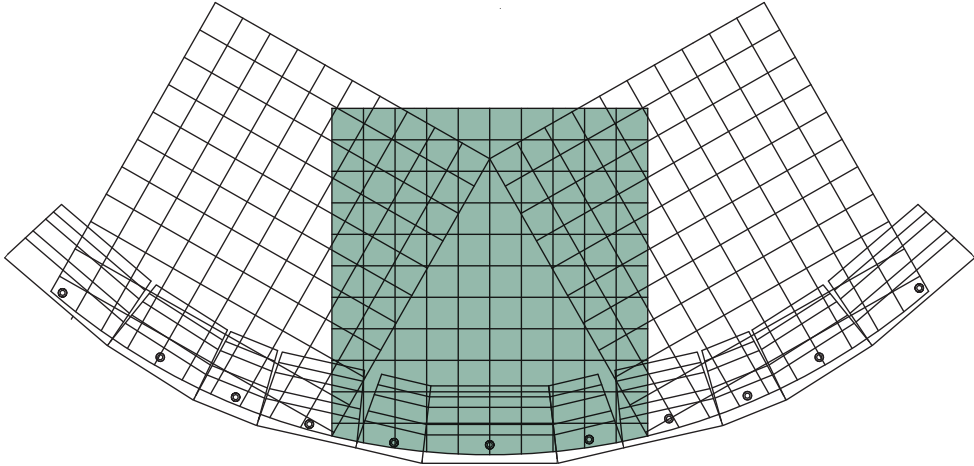

# INSTALLATION GUIDE

## RETAINING WALLS

### FENCING

Fencing can be erected behind the blocks. Fence posts must be placed in formwork tubes positioned during construction of the wall and then filled with concrete. The geogrid may be cut to accommodate installation of the tubes. Cut the geogrid in alignment with the center of the formwork tube and perpendicular to the wall, thus creating two geogrid panels. Connect the two geogrid panels at the front and back of the formwork tube and bend the geogrid to fit around the formwork.

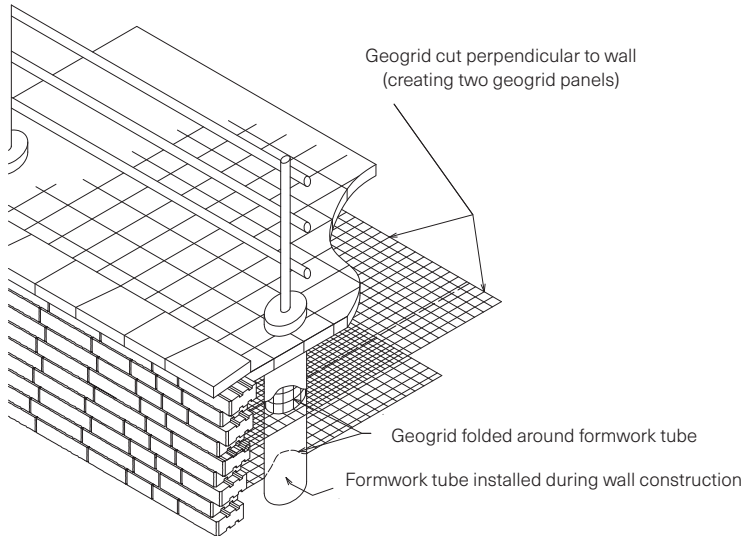

### GUARD RAIL

As with fencing, a guardrail can be incorporated behind the blocks. The guardrail posts must be installed during construction of the wall. The geogrid is cut perpendicular to the wall and in alignment with the center of the post, thus creating two geogrid panels. These two panels are connected at the front and back of the post. The geogrid can be bent to fit around the post.

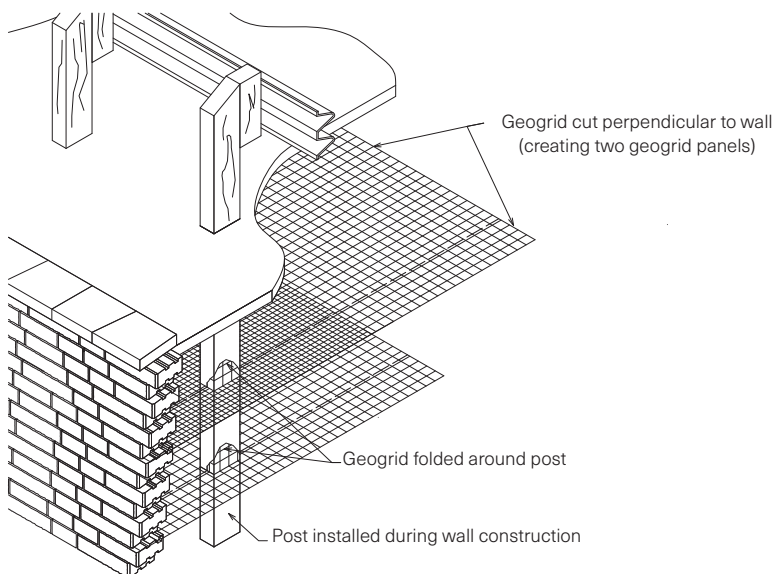

# INSTALLATION GUIDE

## RETAINING WALLS

### TIERED WALL

Although tiered walls look appealing, it is important to take into account the additional load the upper wall applies on the lower wall. If the distance between the walls is at least twice the height of the lower wall, the walls are generally independent of each other. However, if this distance is less the lower wall must be built to take account of the load of the upper wall and geogrids may be required.

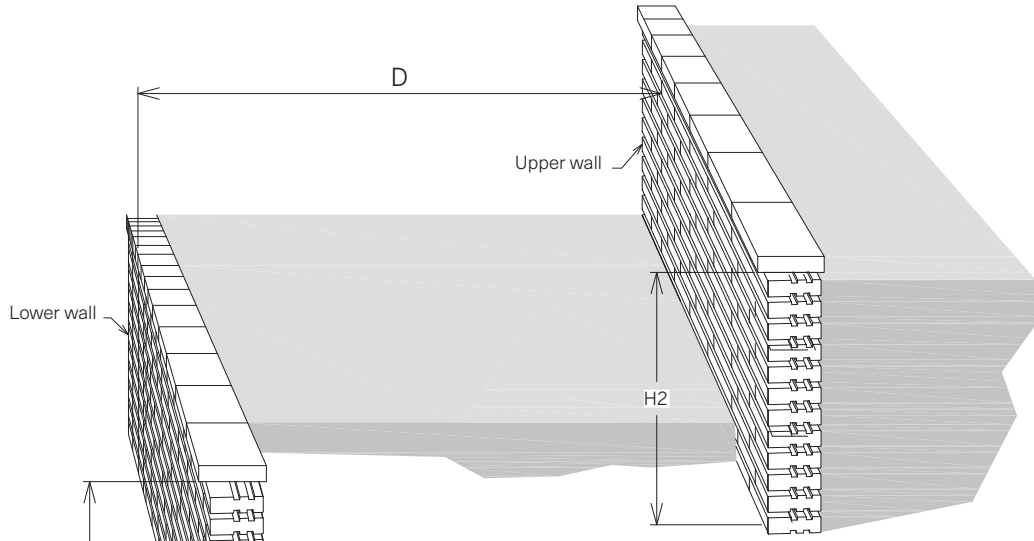

**If  $H_1 > H_2$  and  $D > (H_1 \times 2)$**

The walls are generally independent of each other. Otherwise, the construction of the lower wall must take into account the load of the upper wall (as shown below).

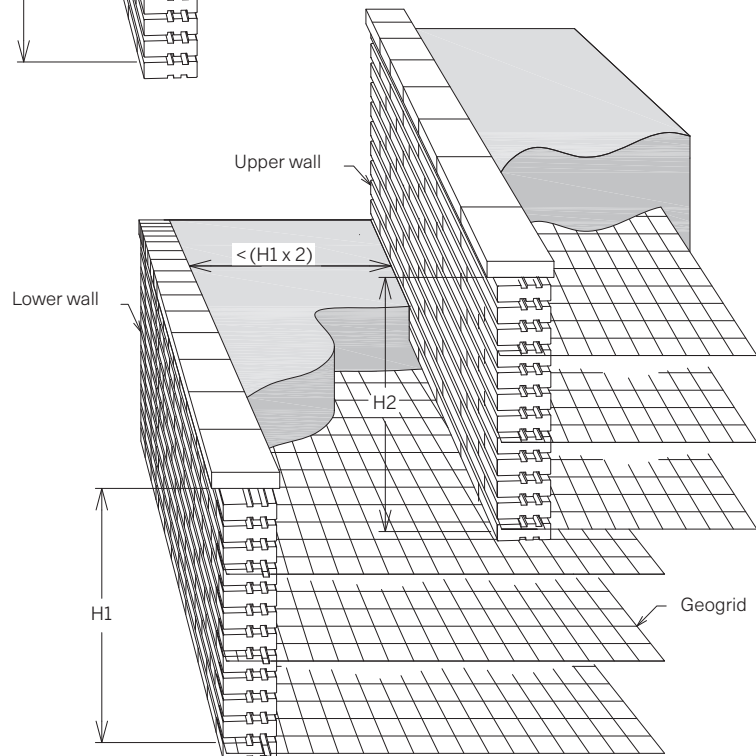

# INSTALLATION GUIDE

## FREESTANDING WALLS

### INSTALLATION OUTLINE

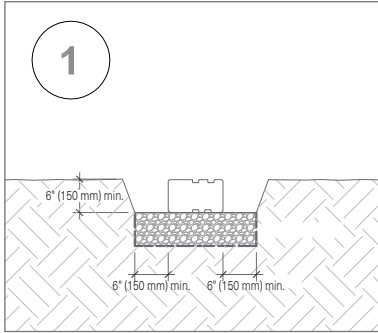

#### 01 EXCAVATION

- Check the location of existing structures and utilities before starting the excavation.
- Dig out a trench. The trench should be 12" wider than the block width (6" (150 mm) at the front and at the back of the wall).
- The trench should be a minimum 12" (300 mm) deep. This depth will provide 6" (150 mm) for the compacted base and a minimum 6" (150 mm) free-standing wall embedment.
- In areas where unstable soils or one particularly affected by freeze-thaw cycles, a thicker compacted base may be necessary.
- The foundation soil should be checked to make sure it is firm, level and capable of supporting the freestanding wall.

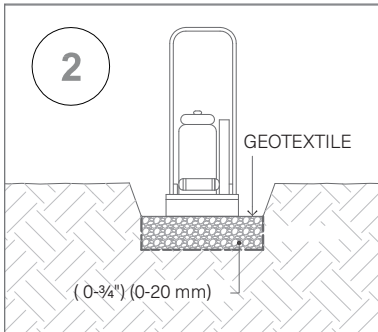

#### 02 FOUNDATION

- Cover the excavated area with a geotextile. Create a leveling pad of compacted aggregate base material. The pad should be composed of 0-3/4" (0-20 mm) crushed stone with a minimum thickness of 6" (150 mm).

#### NOTE FOR STEPPED FOUNDATION

A wall built on an incline requires stepped foundations. For steep inclines, several steps may be required. Construction should start at the lowest level. Each of the steps must follow a level horizontal path and the vertical distance separating the successive steps must equal the height of a block.

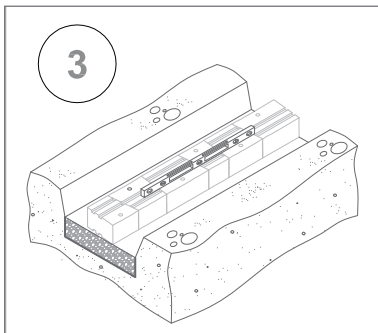

#### 03 BUILDING THE FIRST COURSE

- Using blocks of the same height, place the first course on the compacted leveling pad according to the predetermined layout. Check the alignment and leveling in all directions and make sure that all the blocks are in full contact with the leveling pad and properly supported.
- Place the blocks side by side. There must be no space between adjacent blocks. For alignment of straight walls, use a string line aligned on the connector's slots of applicable units, or back of the block of full solid units.
- For tapered units, alternate front and back faces to obtain straight walls.

# INSTALLATION GUIDE

## FREESTANDING WALLS

### INSTALLATION OUTLINE

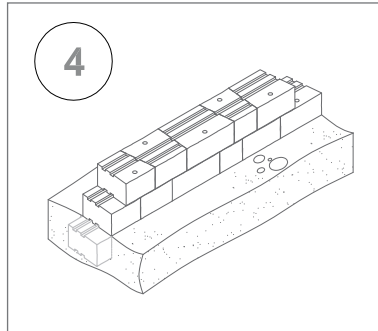

#### 04 SUBSEQUENT COURSES

- A. Clean the top of each block before laying the next course. Depending on the type of block, install the connectors if available on each block.
- B. Stagger joints from one row to the next.
- C. Glue all modules at each row with a concrete adhesive for securing.
- D. All Free-standing walls must be installed in vertical position.
- E. Any cavities in the blocks must be filled with  $\frac{3}{4}$ " (20 mm) clean stone.
- F. Continue building to the desired and permissible height.

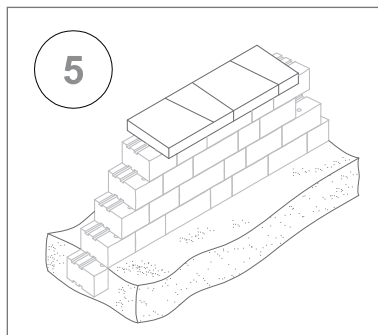

#### 05 FINISHING

- A. Position the cap units (if applicable) or the final course of blocks to complete the wall. The cap units (if applicable) or final course of blocks must be fixed to the subjacent blocks using concrete adhesive and there must be no space between the blocks.

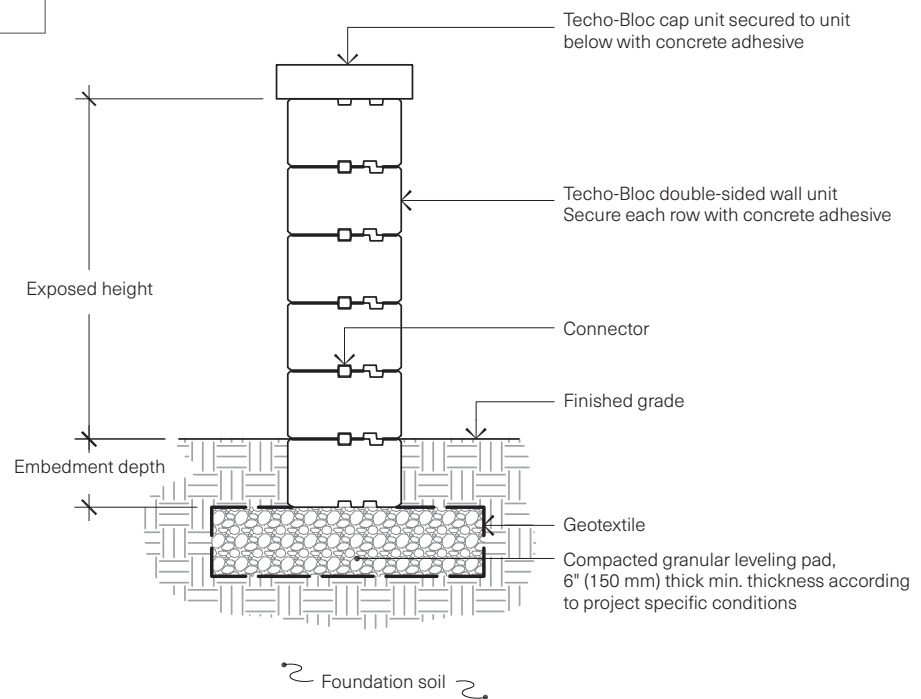

# INSTALLATION GUIDE

## PILLARS

### GENERAL NOTE

It is important to adequately glue each row with a concrete adhesive in order to obtain a stable pillar.

If you are planning to install a light on top of the pillar, make sure you run the electrical wires prior to installing the blocks.

If you are planning to build a pillar with a planter, make sure to install a geotextile membrane inside the pillar before filling the cavity with planting soil.

### INSTALLATION OUTLINE

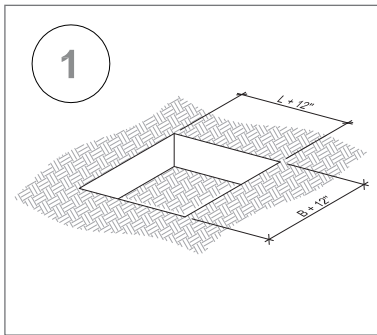

#### 01 EXCAVATION

- A. Check the location of existing structures and utilities before starting the excavation.
- B. Excavate an area that is 12" (300 mm) wider than the pillar (6" [150 mm] at each side of the pillar).
- C. The excavated area should be a minimum 12" (300 mm) deep. This depth will provide 6" (150mm) for the compacted base and a minimum 6" (150 mm) of embedment.
- D. In areas where unstable soils or one particularly affected by freeze-thaw cycles, a thicker compacted base may be necessary.
- E. The foundation soil should be checked to make sure it is firm, level and capable of supporting the pillar.

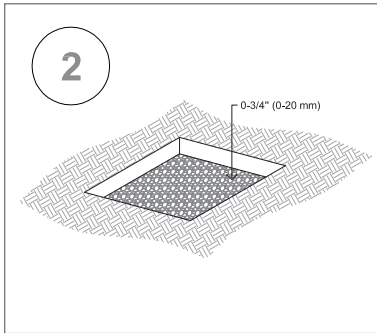

#### 02 FOUNDATION

- A. Cover the excavated area with a geotextile. Create a leveling pad of compacted granular base material. The pad should be composed of 0-3/4" (0-20 mm) crushed stone with a minimum thickness of 6" (150 mm).

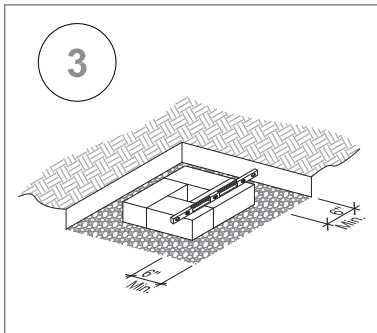

#### 03 BUILDING THE FIRST COURSE

- A. Using the corresponding pillar or corner units, place the first course on the compacted base according to the predetermined layout. Check the alignment and leveling in all directions and make sure that all the blocks are in full contact with the base and properly supported.

# INSTALLATION GUIDE

## PILLARS

### INSTALLATION OUTLINE

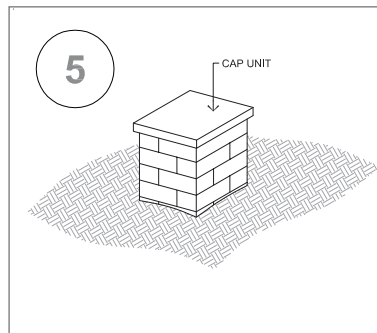
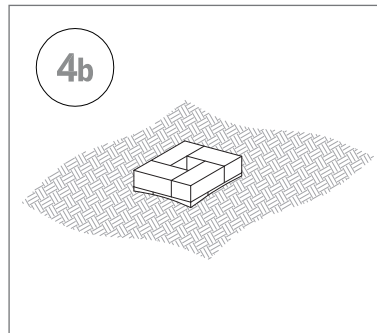
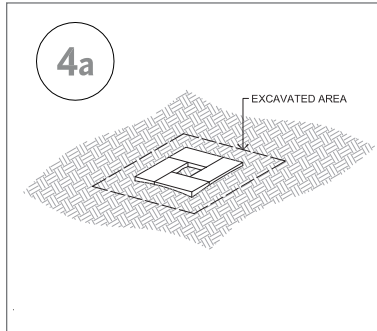

#### 04 SUBSEQUENT COURSES

- Clean the top of each block before laying the next course.
- Stagger joints from one row to the next.
- Glue all modules at each row with a concrete adhesive for securing.
- Backfill the excavated area surrounding the pillar.
- Continue building to desired and permissible height.

#### 05 CROWNING

- Crown the pillar using Techo-Bloc Pillar cap units and securing to blocks underneath with a concrete adhesive.

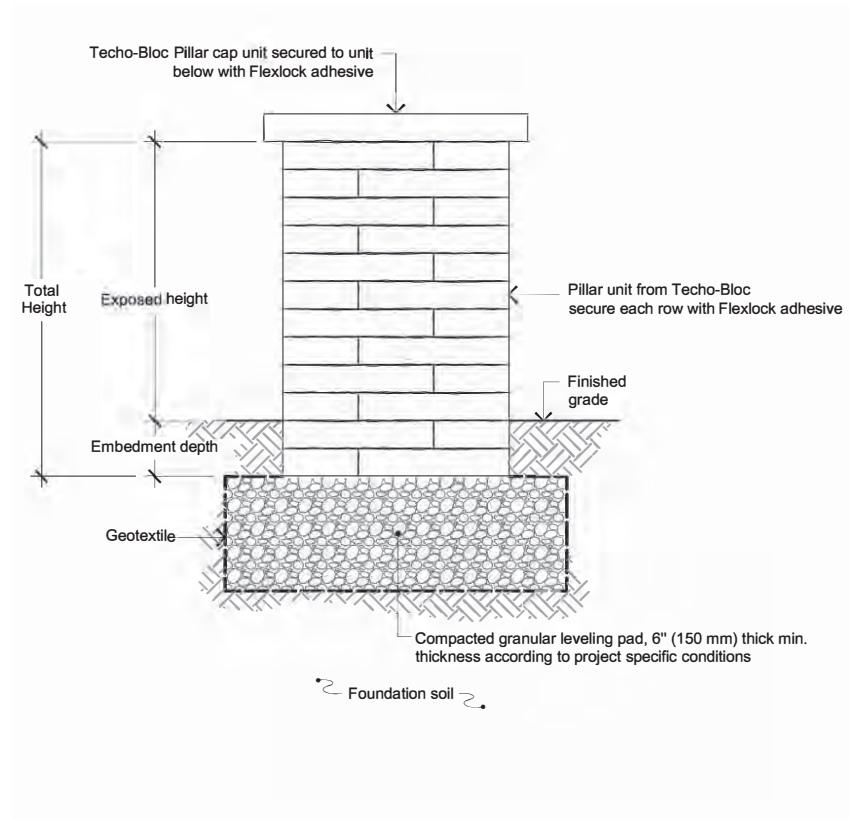



## BOREALIS Wall

DESCRIPTION: Wall TEXTURE: Wood

Specifications per pallet	Imperial	Metric
 Product dimension (L×D×H)	48 × 8 × 6	1 219 × 203 × 152
Cubing	32 ft <sup>2</sup>	2.97 m <sup>2</sup>
16 units / pallet	Linear coverage per pallet	64 lin. ft
Approx. Weight	3 042 lbs	1 380 kg
Number of rows	4	
Coverage per row	8 ft <sup>2</sup>	0.74 m <sup>2</sup>
Coverage per unit	2 ft <sup>2</sup>	0.19 m <sup>2</sup>
Linear coverage per unit	4 lin. ft	1.22 lin. m

### Pallet Overview

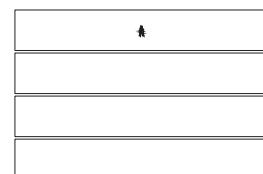

Smoked Pine

Wood

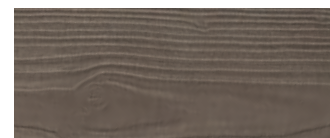

Hazelnut Brandy

Wood

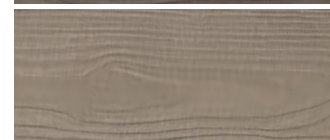

### NOTES

\*For an authentic look, each color option is composed of a variety of darker & lighter tones. Natural ingredients such as granite are present within the recipe to allow for a range in tones, veining and textures from one stone to another.

The dimensional tolerance for Stonedge wet cast retaining wall units is: ± 3/16" (5 mm) for height and ± 1/2" (13 mm) for length and width. During the installation, the level between adjacent wall units

will vary (usually more than for a dry cast wall unit) in order to obtain a more realistic appearance of a natural stone wall.

See page 6 for icons description.

See page 146 to 161 for more technical information.

# INSTALLATION GUIDE

## FREESTANDING WALLS- BOREALIS

### BOREALIS

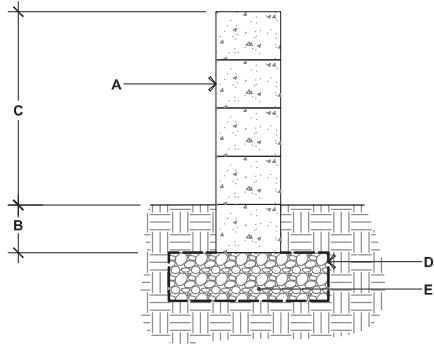

- A. BOREALIS DOUBLE-SIDED WALL UNITS  
SECURE EACH ROW WITH CONCRETE ADHESIVE
- B. EMBEDMENT DEPTH, 6" (150 mm) MIN.
- C. 24" (612 mm) MAX.
- D. GEOTEXTILE
- E. COMPACTED GRANULAR LEVELING PAD, 6" (150 mm) THICK MIN. THICKNESS  
ACCORDING TO PROJECT SPECIFIC CONDITIONS

## 90° CORNER OF A DOUBLE-SIDED WALL

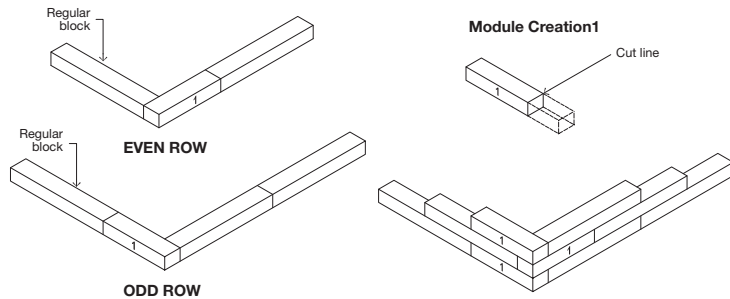

1. Alternate odd and even rows.
2. Stagger joints from one row to the next.
3. Glue all modules at each row with Concrete adhesive.

## DOUBLE-SIDED WALL - END OF A STRAIGHT WALL

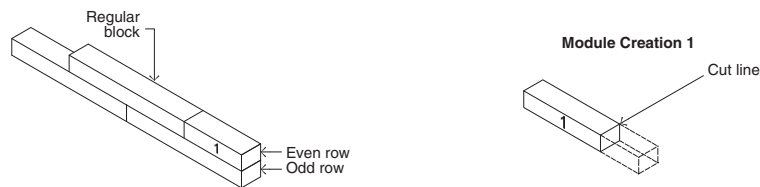

# INSTALLATION GUIDE

## GRILL ISLAND - BOREALIS

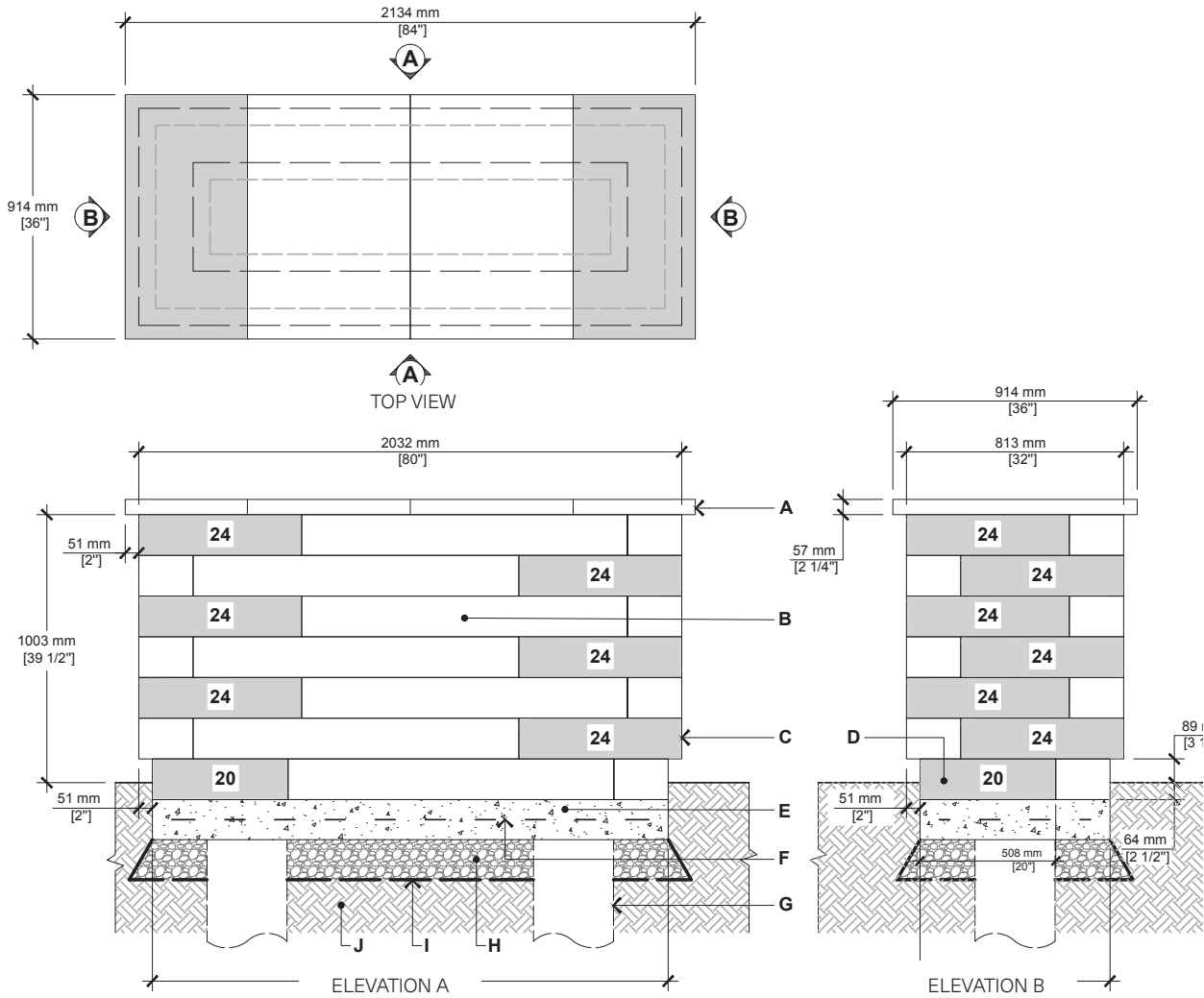

- A. YORK COUNTER TOP 24" X 36" X 2 1/4" (CUT ON FIELD AS REQUIRED)
- B. BOREALIS WALL UNIT
- C. BOREALIS WALL UNIT CUT IN HALF (CUT ON FIELD)
- D. BOREALIS WALL UNIT (CUT ON FIELD AS REQUIRED)
- E. CAST IN PLACE CONCRETE SLAB 4350 psi (30 MPa), 5" (125 mm) THICK
- F. 4X4-4/4 (102X102-MW25.8XMW25.8) WELDED WIRE MESH AND/OR REBAR AS PER SITE CONDITIONS
- G. 12" (300 mm) DIA. CONCRETE PILLAR, AS PER LOCAL CODE
- H. 3/4" (20 mm) CLEAN STONE 6" (150 mm) THICK MIN. AS PER SITE CONDITIONS
- I. GEOTEXTILE
- J. NATURAL SOIL OR COMPACTED BACKFILL

### QUANTITY OF MATERIALS REQUIRED

- York Counter top 24" x 36" x 2 1/4": **4**
- Borealis wall unit: **28**

**NOTE:** Appliances and utilities may vary for each project and are not shown on this drawing. This drawing is shown for inspiration only and surplus or shortage of materials may result. It is the user's responsibility to verify for the quantity of materials required. Secure the blocks using a heat resistant concrete adhesive. The installer must ensure that the installation and use of the grill island comply with local regulations and code requirements. Concrete pillars extending to frost line may be required as per local code. Check your local building code before installing.



D ❄️

**BRANDON 90 mm**

**DESCRIPTION:** Double-sided wall **TEXTURE:** Slate

**Pallet Overview**

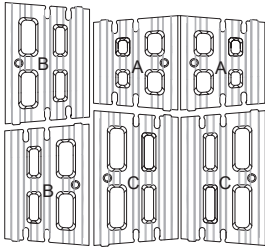

Slate Chestnut Brown  
Slate Champlain Grey  
Slate Caffè Crema  
Slate Shale Grey  
Slate Onyx Black

**Specifications per pallet**

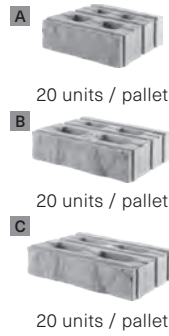

	Imperial	Metric
<b>A</b> Dimension Front (L x D x H) <b>A</b>	11 ¼ x 9 13/16 x 3 9/16	285 x 250 x 90
Dimension Back (L x D x H) <b>A</b>	9 5/8 x 9 13/16 x 3 9/16	245 x 250 x 90
<b>B</b> Dimension Front (L x D x H) <b>B</b>	14 3/8 x 9 13/16 x 3 9/16	365 x 250 x 90
Dimension Back (L x D x H) <b>B</b>	12 13/16 x 9 13/16 x 3 9/16	325 x 250 x 90
<b>C</b> Dimension Front (L x D x H) <b>C</b>	15 15/16 x 9 13/16 x 3 9/16	405 x 250 x 90
Dimension Back (L x D x H) <b>C</b>	14 3/8 x 9 13/16 x 3 9/16	365 x 250 x 90
Cubing	20.44 ft <sup>2</sup>	1.90 m <sup>2</sup>
Approx. Weight	69.23 lin. ft	21.10 lin. m
Minimum radius	1 684 lbs	764 kg
Number of rows	7.5 ft	2.3 m
Coverage per row	10	
Lin. coverage per row	2.04 ft <sup>2</sup>	0.19 m <sup>2</sup>
	6.92 lin. ft	2.11 lin. m

**NOTES**

See page 6 for icons description.

**COMPATIBLE CAPS**

See page 145 for product compatibility.

When building a double-sided wall one pallet will cover an average of 19.28 ft<sup>2</sup>.



See page 146 to 161 for more technical information.



D ❄️

# BRANDON 180 mm

DESCRIPTION: Double-sided wall TEXTURE: Slate

Specifications per pallet		Imperial	Metric
<b>A</b> 	Dimension Front (L×D×H) <b>A</b>	11 ¼ × 9 13⁄16 × 7 1⁄16	285 × 250 × 180
	Dimension Back (L×D×H) <b>A</b>	9 5⁄8 × 9 13⁄16 × 7 1⁄16	245 × 250 × 180
	Dimension Front (L×D×H) <b>B</b>	14 3⁄8 × 9 13⁄16 × 7 1⁄16	365 × 250 × 180
<b>B</b> 	Dimension Back (L×D×H) <b>B</b>	12 13⁄16 × 9 13⁄16 × 7 1⁄16	325 × 250 × 180
	Dimension Front (L×D×H) <b>C</b>	15 15⁄16 × 9 13⁄16 × 7 1⁄16	405 × 250 × 180
	Dimension Back (L×D×H) <b>C</b>	14 3⁄8 × 9 13⁄16 × 7 1⁄16	365 × 250 × 180
<b>C</b> 	Cubing	20.44 ft <sup>2</sup>	1.90 m <sup>2</sup>
		34.61 lin. ft	10.55 lin. m
	Approx. Weight	1 719 lbs	780 kg
	Minimum radius	7.5 ft	2.3 m
	Number of rows	5	
	Coverage per row	4.09 ft <sup>2</sup>	0.38 m <sup>2</sup>
Lin. coverage per row	6.92 lin. ft	2.11 lin. m	

## Pallet Overview

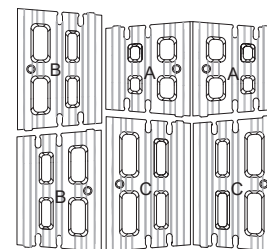

Chestnut Brown  
Champlain Grey  
Caffè Crema  
Shale Grey  
Onyx Black

Slate  
Slate  
Slate  
Slate  
Slate

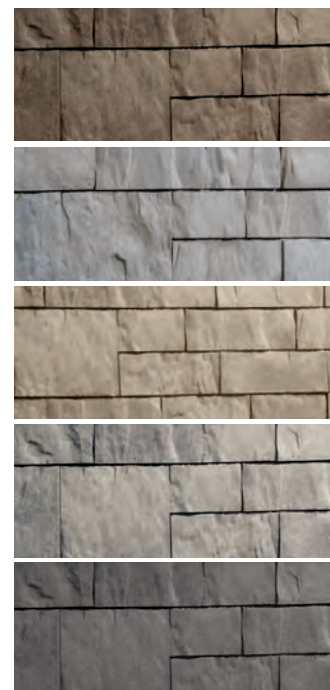

## NOTES

See page 6 for icons description.

### COMPATIBLE CAPS

See page 145 for product compatibility.

When building a double-sided wall one pallet will cover an average of 19.28 ft<sup>2</sup>.

See page 146 to 161 for more technical information.

D ❄️

## BRANDON 90 mm & 180 mm

DESCRIPTION: Pillars TEXTURE: Slate

### Pallet Overview

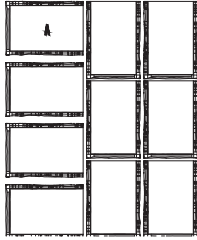

#### Pillar 90 mm

##### Specifications per pallet



40 units / pallet

	Imperial	Metric
Product dimension (L x D x H)	14 3/16 x 9 1/16 x 3 5/16	360 x 250 x 90
Cubing	40 units	40 units
Approx. Weight	1 625 lbs	737 kg
Number of rows	4	
Pillar height	35 7/16 in	900 mm

#### Pillar 180 mm

##### Specifications per pallet



20 units / pallet

	Imperial	Metric
Product dimension (L x D x H)	14 3/16 x 9 1/16 x 7 1/16	360 x 250 x 180
Cubing	20 units	20 units
Approx. Weight	1 636 lbs	742 kg
Number of rows	2	
Pillar height	35 7/16 in	900 mm



Slate

Chestnut Brown

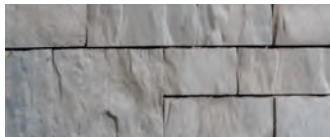

Slate

Champlain Grey



Slate

Caffè Crema



Slate

Shale Grey



Slate

Onyx Black

### NOTES

See page 6 for icons description.

#### COMPATIBLE CAPS

See page 145 for product compatibility.

See page 146 to 161 for more technical information.

# TECHO—BLOC

## DESIGN CHART BRANDON 180 mm

(EQUIVALENT TO TWICE THE BRANDON 90 mm)

SETBACK VERTICAL

CLEAN SAND/GRAVEL/ SAND AND GRAVEL MIXES ( $\phi=34^\circ$ ,  $\gamma = 120$  pcf)  
GEOGRID: MIRAGRID 3XT BY TENCATE (RFd=1.10, RFcr=1.45, RFid=1.25, Cds=0.9, Ci=0.9)

**CASE N° 1 :**  
No Surcharge  
No Backslope  
No Toe Slope

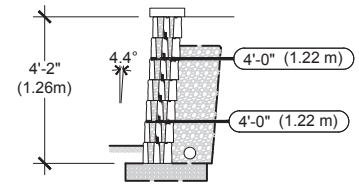
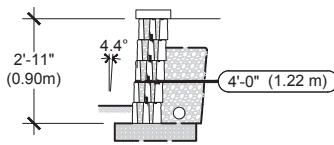
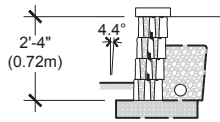

VISIT [WWW.TECHO-BLOC.COM](http://WWW.TECHO-BLOC.COM) FOR COMPLETE DESIGN CHART DOCUMENT  
(USA AND CANADA VERSIONS)

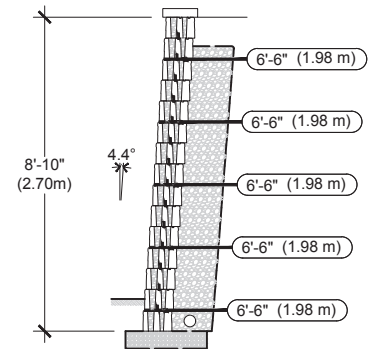
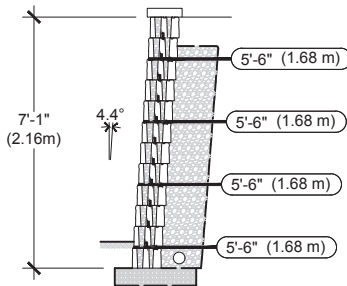
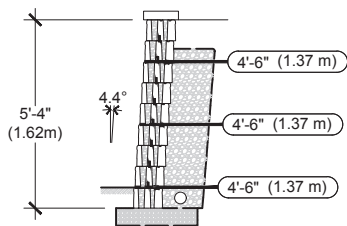

1. The information contained in the design charts is supplied for information purposes only and as such should only be used for preliminary designs.
2. The height (H) of the wall is the total height from the leveling pad to the top of the wall not including the thickness of the cap.
3. Soil parameters: reinforced soil ( $\phi = 34^\circ$ ,  $\gamma = 120$  pcf); retained soil ( $\phi = 34^\circ$ ,  $\gamma = 120$  pcf); foundation soil ( $\phi = 34^\circ$ ,  $\gamma = 120$  pcf)
4. A qualified engineer should be consulted for the final design to be used for construction.
5. The foundation soil must be able to support the wall system. The bearing capacity of the foundation soil, settlement, and global stability must be verified and validated by a qualified geotechnical engineer.
6. The seismic analysis is not included.
7. The design charts do not apply to tiered walls.
8. The charts assume that the walls are constructed in accordance with Techo-Bloc specifications, good construction practice and an adequate drainage system.
9. The geogrid layout has been optimized to satisfy the design requirements of the NCMA's Design Manual for Segmental Retaining Walls, 3rd Edition.
10. The minimum burial depth must be 6 in (150 mm) or 10% of the exposed height, whichever is greater.
11. Engineering judgement should be used when interpolating between heights.
12. Techo-Bloc and its predecessors, successors, beneficiaries, employees, associates, administrators and insurers accepts no liability for the incorrect use of information contained in the design charts.
13. For further information, please contact our technical service department.

# INSTALLATION GUIDE

## RETAINING WALLS - BRANDON 90 & 180 mm

The different modules of the Brandon retaining wall allow the installation of different block combinations.

Twelve combinations are shown as an example. Each combination is 41 1/2" (1055 mm) long and 10 5/8" (270 mm) high.

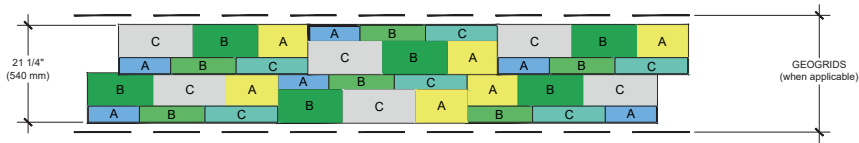
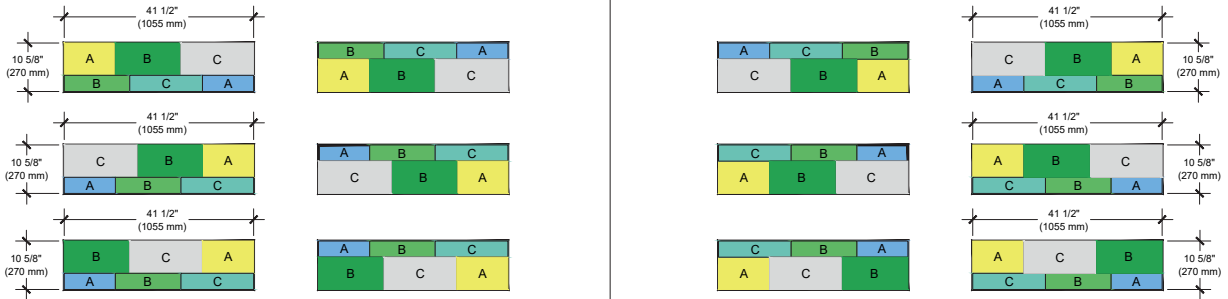

NUMBER OF BLOCKS REQUIRED

MODULE

BRANDON	A	B	C
33% of the surface - Brandon 90 mm	6	6	6
67% of the surface - Brandon 180 mm	6	6	6

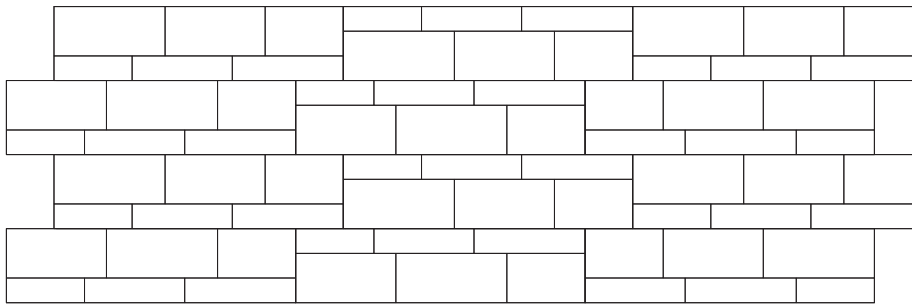

# INSTALLATION GUIDE

## FREESTANDING WALLS - BRANDON 90 & 180 mm

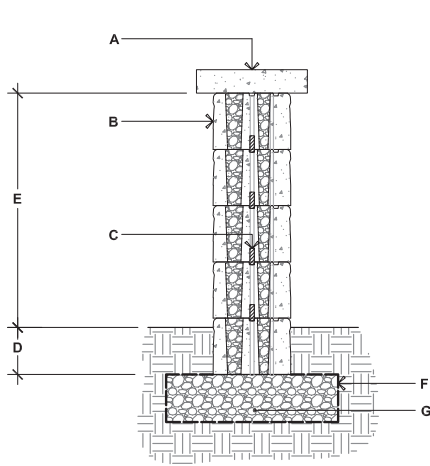

### BRANDON 90 mm & 180 mm

- A. TECHO-BLOC CAP UNIT SECURED TO UNIT BELOW WITH CONCRETE ADHESIVE
- B. BRANDON 90 mm AND 180 mm DOUBLE-SIDED WALL UNITS SECURE EACH ROW WITH CONCRETE ADHESIVE
- C. CONNECTOR
- D. EMBEDMENT DEPTH, 6" (150 mm) MIN.
- E. 29 7/16" (750 mm) MAX.
- F. GEOTEXTILE
- G. COMPACTED GRANULAR LEVELING PAD, 6" (150 mm) THICK MIN. THICKNESS ACCORDING TO PROJECT SPECIFIC CONDITIONS

## 90° CORNER OF A DOUBLE-SIDED WALL

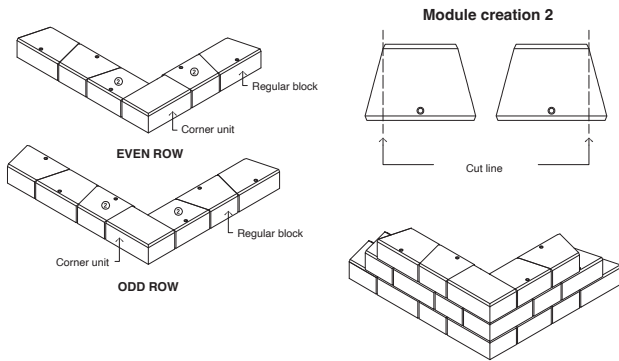

1. Alternate odd and even rows.
2. Stagger joints from one row to the next.
3. Glue all modules at each row with concrete adhesive.
4. Cavities, grooves and connectors are not illustrated to avoid overloading the image.

## DOUBLE-SIDED WALL - END OF A STRAIGHT WALL

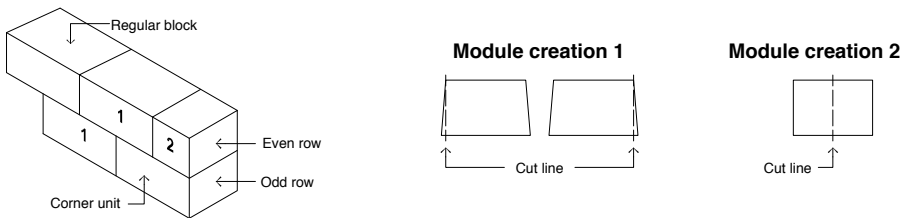

### GENERAL NOTES

1. Alternate odd and even rows.
2. Stagger joints from one row to the next.
3. Glue all modules at each row with concrete adhesive.
4. Cavities, grooves and connectors are not illustrated to avoid overloading the image.

# INSTALLATION GUIDE

## DOUBLE-SIDED WALL RADIUS - BRANDON 90 & 180 mm

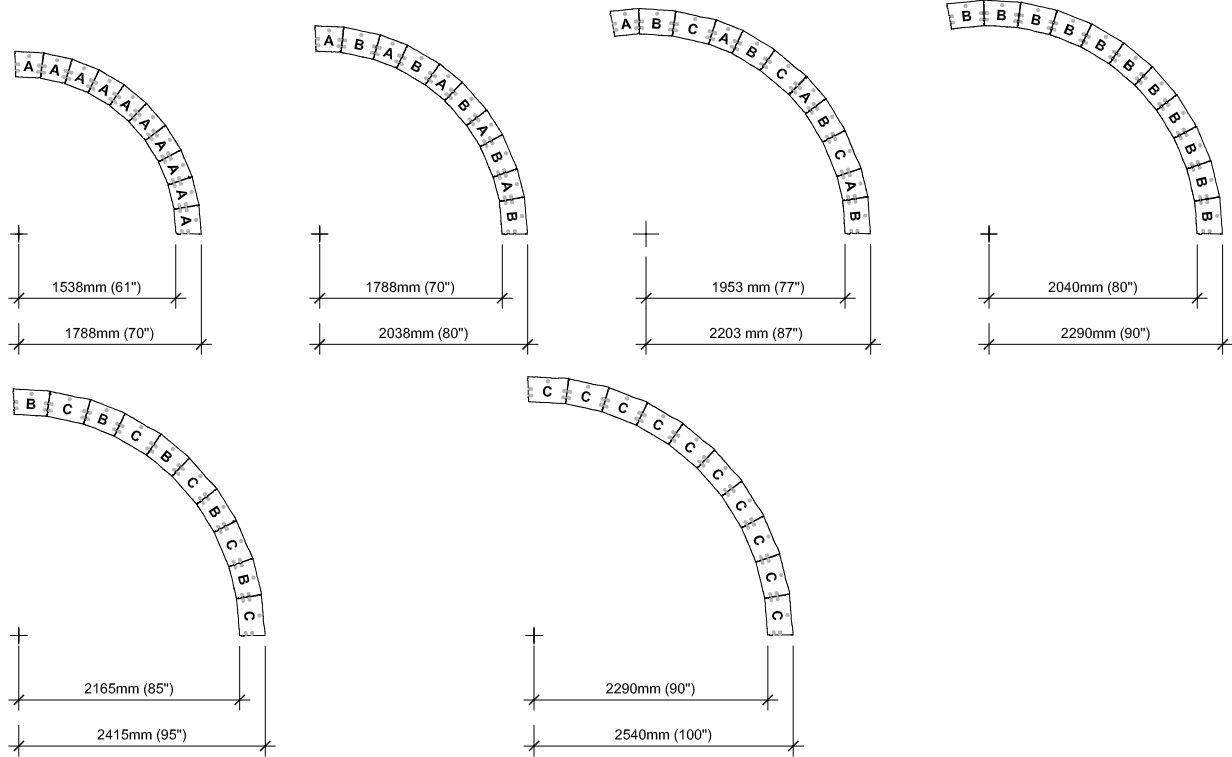

It is the user's responsibility to verify for the quantity of materials required.

## STEPS

### BRANDON 90 mm

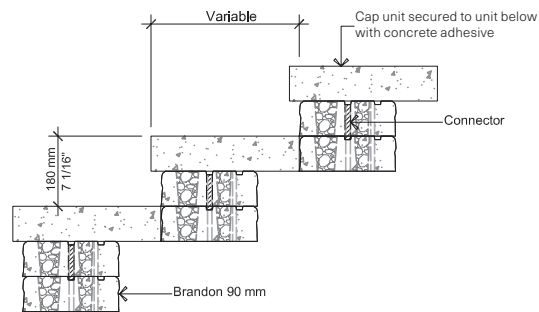

### BRANDON 180 mm

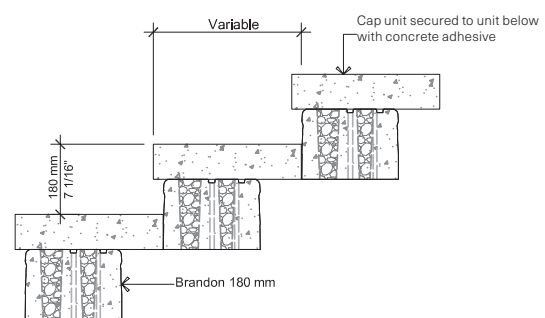

For all possible combinations of pillars and caps, please refer to the correspondence table on page 145

Check with your local Building Codes to determine any restrictions or guidelines regarding the dimensions of steps (including riser height and step tread) as well as handrail specifications.

PLEASE REFER TO P.4 FOR THE CORRECT USE AND LIMITATIONS OF PROVIDED TECHNICAL INFORMATION.

# INSTALLATION GUIDE

## PILLARS - BRANDON 90 & 180 mm

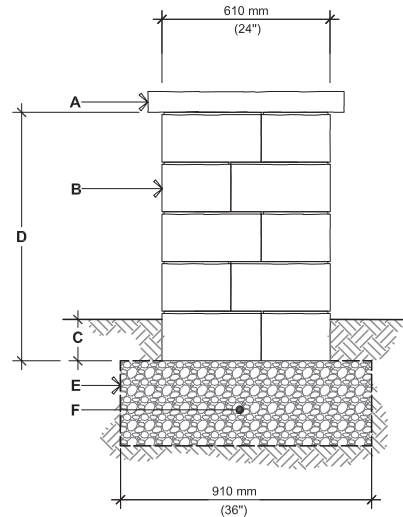
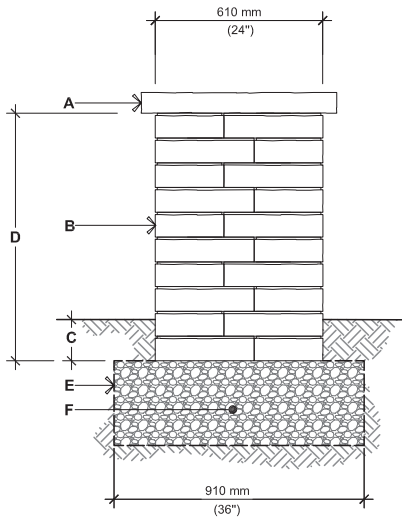

### BRANDON 90 mm

- A. PILLAR CAP UNIT, SECURE TO UNITS BELOW WITH CONCRETE ADHESIVE
- B. BRANDON 90 mm PILLAR UNIT SECURE EACH ROW WITH CONCRETE ADHESIVE
- C. EMBEDMENT DEPTH: 150 mm (6") MIN.
- D. 900 mm (35 7/16"), HEIGHT PER PALLET 1 080 mm (42 1/2"), MAXIMUM HEIGHT
- E. GEOTEXTILE
- F. COMPACTED GRANULAR BASE 150 mm (6") THICK MIN. THICKNESS ACCORDING TO PROJECT SPECIFIC CONDITIONS

### BRANDON 180 mm

- A. PILLAR CAP UNIT, SECURE TO UNITS BELOW WITH CONCRETE ADHESIVE
- B. BRANDON 180 mm PILLAR UNIT SECURE EACH ROW WITH CONCRETE ADHESIVE
- C. EMBEDMENT DEPTH: 150 mm (6") MIN.
- D. 900 mm (35 7/16"), HEIGHT PER PALLET 1 080 mm (42 1/2"), MAXIMUM HEIGHT
- E. GEOTEXTILE
- F. COMPACTED GRANULAR BASE 150 mm (6") THICK MIN. THICKNESS ACCORDING TO PROJECT SPECIFIC CONDITIONS

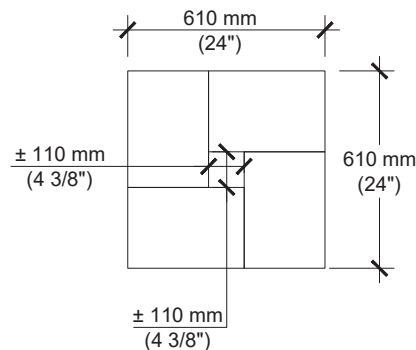

For all possible combinations of pillars and caps, please refer to the correspondence table on page 145

# INSTALLATION GUIDE

## PILLARS - BRANDON 90 & 180 mm

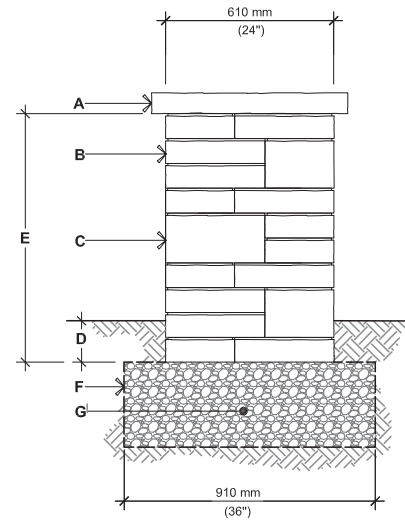
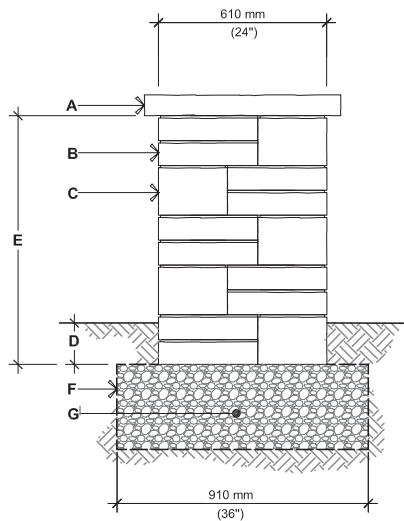

**BRANDON 90 mm & 180 mm**  
OPTION A

**BRANDON 90 mm & 180 mm**  
OPTION B

- A.** PILLAR CAP UNIT, SECURE TO UNITS BELOW WITH CONCRETE ADHESIVE
- B.** BRANDON 90 mm PILLAR UNIT SECURE EACH ROW WITH CONCRETE ADHESIVE
- C.** BRANDON 180 mm PILLAR UNIT SECURE EACH ROW WITH CONCRETE ADHESIVE
- D.** EMBEDMENT DEPTH: 150 mm (6") MIN.
- E.** 900 mm (35 7/8"), 1 080 mm (42 1/2"), MAXIMUM HEIGHT
- F.** GEOTEXTILE
- G.** COMPACTED GRANULAR BASE 150 mm (6") THICK MIN. THICKNESS ACCORDING TO PROJECT SPECIFIC CONDITIONS

- A.** PILLAR CAP UNIT, SECURE TO UNITS BELOW WITH CONCRETE ADHESIVE
- B.** BRANDON 90 mm PILLAR UNIT SECURE EACH ROW WITH CONCRETE ADHESIVE
- C.** BRANDON 180 mm PILLAR UNIT SECURE EACH ROW WITH CONCRETE ADHESIVE
- D.** EMBEDMENT DEPTH: 150 mm (6") MIN.
- E.** 900 mm (35 7/8"), 1 080 mm (42 1/2"), MAXIMUM HEIGHT
- F.** GEOTEXTILE
- G.** COMPACTED GRANULAR BASE 150 mm (6") THICK MIN. THICKNESS ACCORDING TO PROJECT SPECIFIC CONDITIONS

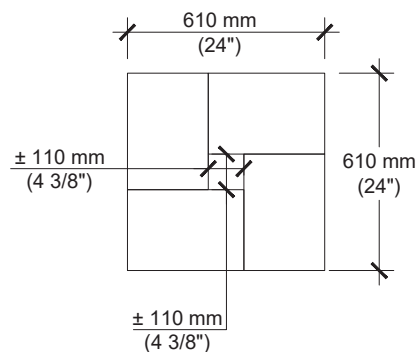

For all possible combinations of pillars and caps, please refer to the correspondence table on page 145

# INSTALLATION GUIDE

## GRILL ISLAND - BRANDON 90 & 180 mm

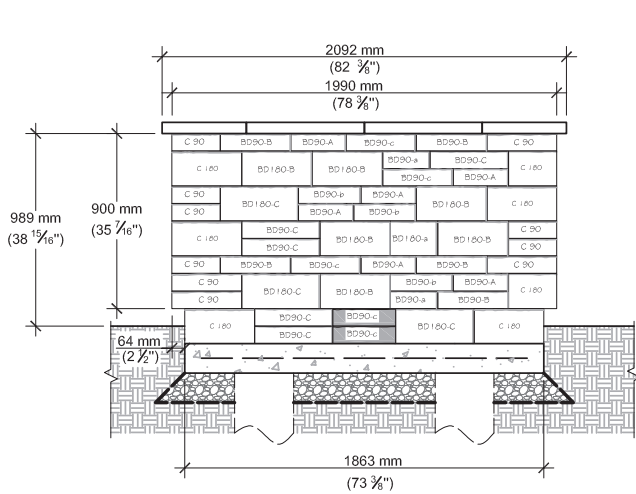

ELEVATION A

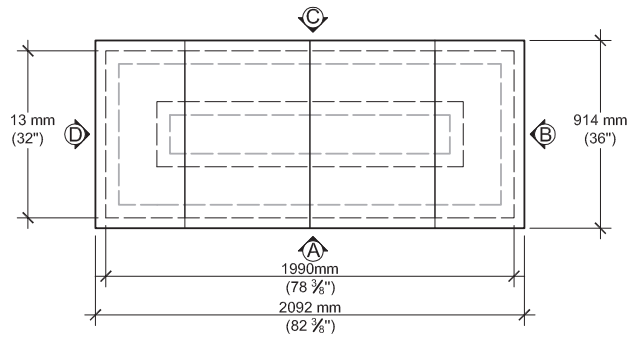

TOP VIEW

- A. YORK COUNTER TOP 24" x 36" x 2 1/4"
- B. BRANDON 90 mm UNIT (A, B OR C) – LONG FACE EXPOSED (SHOWN WITH UPPERCASE LETTER)
- C. BRANDON 90 mm UNIT (A, B OR C) – SHORT FACE EXPOSED (SHOWN WITH LOWERCASE LETTER)
- D. BRANDON 180 mm UNIT (A, B OR C) – LONG FACE EXPOSED (SHOWN WITH UPPERCASE LETTER)
- E. BRANDON 180 mm UNIT (A, B OR C) – SHORT FACE EXPOSED (SHOWN WITH LOWERCASE LETTER)
- F. BRANDON 90 mm PILLAR UNIT
- G. BRANDON 180 mm PILLAR UNIT
- H. BRANDON UNIT CUT ON FIELD
- I. CAST IN PLACE CONCRETE SLAB 4350 psi (30 MPa), 5" (125 mm) THICK
- J. 4X4-4/4 (102x102-MW25.8xMW25.8) WELDED WIRE MESH AND/OR REBAR AS PER SITE CONDITIONS
- K. 12" (300 mm) DIA. CONCRETE PILLAR, AS PER LOCAL CODE
- L. 3/4" (20 mm) CLEAN STONE 6" (150 mm) THICK MIN. AS PER SITE CONDITIONS
- M. NATURAL SOIL OR COMPACTED BACKFILL
- N. GEOTEXTILE

### QUANTITY OF MATERIALS REQUIRED

- York Counter top 24" x 36" x 2 1/4": **4**
- Brandon 90 mm unit: **20 A, 20 B, 18 C**
- Brandon 180 mm unit: **10 A, 10 B, 9 C**
- Brandon 90 mm Pillar unit: **18**
- Brandon 180 mm Pillar unit: **15**

**NOTE:** Appliances and utilities may vary for each project and are not shown on this drawing. This drawing is shown for inspiration only and surplus or shortage of materials may result. It is the user's responsibility to verify for the quantity of materials required. Secure the blocks using a heat resistant concrete adhesive. The installer must ensure that the installation and use of the grill island comply with local regulations and code requirements. Concrete pillars extending to frost line may be required as per local code. Check your local building code before installing.

# INSTALLATION GUIDE

## GRILL ISLAND - BRANDON 90 & 180 mm - Cont'd

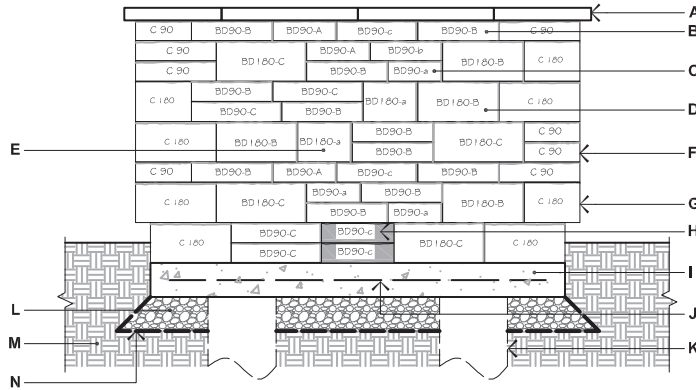

ELEVATION C

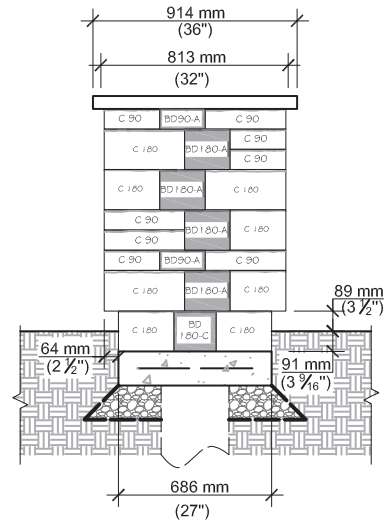

ELEVATION B

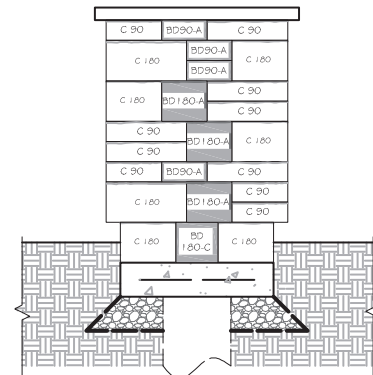

ELEVATION D

- A. YORK COUNTER TOP 24" x 36" x 2 1/4"
- B. BRANDON 90 mm UNIT (A, B OR C) – LONG FACE EXPOSED (SHOWN WITH UPPERCASE LETTER)
- C. BRANDON 90 mm UNIT (A, B OR C) – SHORT FACE EXPOSED (SHOWN WITH LOWERCASE LETTER)
- D. BRANDON 180 mm UNIT (A, B OR C) – LONG FACE EXPOSED (SHOWN WITH UPPERCASE LETTER)
- E. BRANDON 180 mm UNIT (A, B OR C) – SHORT FACE EXPOSED (SHOWN WITH LOWERCASE LETTER)
- F. BRANDON 90 mm PILLAR UNIT
- G. BRANDON 180 mm PILLAR UNIT
- H. BRANDON UNIT CUT ON FIELD
- I. CAST IN PLACE CONCRETE SLAB 4350 psi (30 MPa), 5" (125 mm) THICK
- J. 4X4-4/4 (102x102-MW25.8xMW25.8) WELDED WIRE MESH AND/OR REBAR AS PER SITE CONDITIONS
- K. 12" (300 mm) DIA. CONCRETE PILLAR, AS PER LOCAL CODE
- L. 3/4" (20 mm) CLEAN STONE 6" (150 mm) THICK MIN. AS PER SITE CONDITIONS
- M. NATURAL SOIL OR COMPACTED BACKFILL
- N. GEOTEXTILE

### QUANTITY OF MATERIALS REQUIRED

- York Counter top 24" x 36" x 2 1/4": **4**
- Brandon 90 mm unit: **20 A, 20 B, 18 C**
- Brandon 180 mm unit: **10 A, 10 B, 9 C**
- Brandon 90 mm Pillar unit: **18**
- Brandon 180 mm Pillar unit: **15**

**NOTE:** Appliances and utilities may vary for each project and are not shown on this drawing. This drawing is shown for inspiration only and surplus or shortage of materials may result. It is the user's responsibility to verify for the quantity of materials required. Secure the blocks using a heat resistant concrete adhesive. The installer must ensure that the installation and use of the grill island comply with local regulations and code requirements. Concrete pillars extending to frost line may be required as per local code. Check your local building code before installing.



# D

## FASCIA wall collection

**DESCRIPTION:** Base and Structural block single-sided & double-sided **TEXTURE:** Smooth

### SINGLE-SIDED

Specifications per pallet	Imperial	Metric	
 96 units / pallet	Product dimension (L x D x H)	7 7/8 x 9 1/4 x 5 7/8	200 x 235 x 150
	Cubing	96 units	96 units
		31.00 ft <sup>2</sup>	2.88 m <sup>2</sup>
		62.99 lin. ft	19.20 lin. m
	Approx. Weight	2 612 lbs	1 185 kg
	Number of rows	4	
	Coverage per row	7.75 ft <sup>2</sup>	0.72 m <sup>2</sup>
	Linear coverage per row	15.75 lin. ft	4.80 lin. m

### DOUBLE-SIDED

Specifications per pallet	Imperial	Metric	
 72 units / pallet	Product dimension (L x D x H)	7 7/8 x 11 1/6 x 5 7/8	200 x 281 x 150
	Cubing	72 units	72 units
		23.25 ft <sup>2</sup>	2.16 m <sup>2</sup>
		47.24 lin. ft	14.40 lin. m
	Approx. Weight	2 138 lbs	970 kg
	Number of rows	4	
	Coverage per row	5.81 ft <sup>2</sup>	0.54 m <sup>2</sup>
	Linear coverage per row	11.81 lin. ft	3.60 lin. m

### BASE

Specifications per pallet	Imperial	Metric	
 66 units / pallet	Product dimension (L x D x H)	23 5/8 x 12 x 2 3/8	600 x 305 x 60
	Cubing	66 units	66 units
		25.58 ft <sup>2</sup>	2.38 m <sup>2</sup>
		129.92 lin. ft	39.60 lin. m
	Approx. Weight	3 701 lbs	1 679 kg
	Number of rows	11	
	Coverage per row	2.33 ft <sup>2</sup>	0.22 m <sup>2</sup>
	Linear coverage per row	11.81 lin. ft	3.60 lin. m

### NOTES

See page 6 for icons description.

#### COMPATIBLE CAPS

See page 145 for product compatibility..

See page 146 to 161 for more technical information.

### Pallet Overview - single-sided

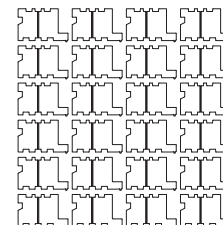

### Pallet Overview - double-sided

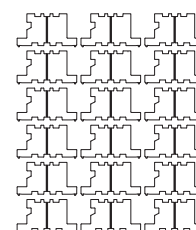

### Pallet Overview - base



The top of Fascia Panels shall not be left exposed, they must be stabilized with a structural block on top or glued to the cap.

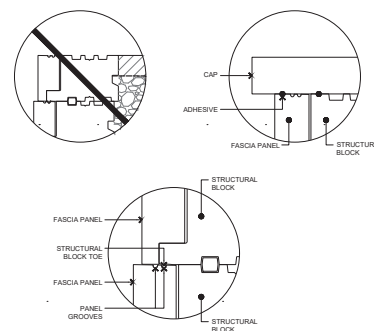



## ICONIC Fascia wall collection

DESCRIPTION: Fascia Panel & Corner TEXTURE: Klean-Bloc Slate

### Pallet Overview- panels

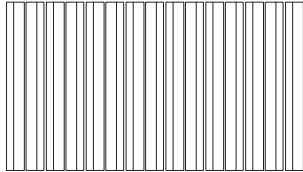

### Pallet Overview- corners

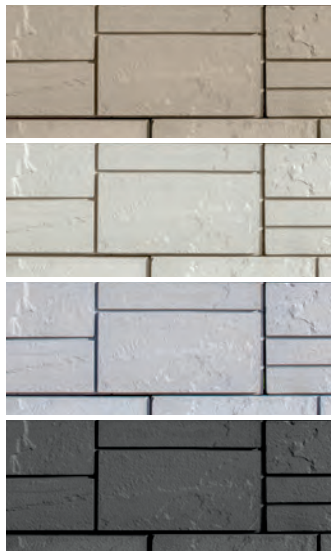
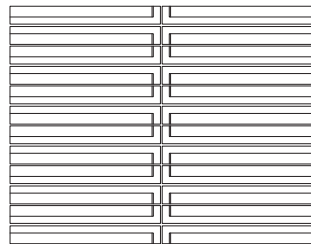

Klean-Bloc Natural Stone  
Rock Garden Brown

Klean-Bloc Natural Stone  
Victoria

Klean-Bloc Natural Stone  
Riviera

Klean-Bloc Natural Stone  
Onyx Black

### FASCIA

#### Specifications per pallet



42 units / pallet

	Imperial	Metric
Product dimension (L x D x H)	26 x 2 3/4 x 5 7/8	660 x 70 x 150
Cubing	42 units	42 units
	44.75 ft <sup>2</sup>	4.16 m <sup>2</sup>
	90.94 lin. ft	27.72 lin. m
Approx. Weight	1 250 lbs	567 kg
Number of rows	7	
Coverage per row	6.39 ft <sup>2</sup>	0.60 m <sup>2</sup>
Linear coverage per row	13.03 lin. ft	3.96 lin. m

### CORNER

#### Specifications per pallet



Left unit  
12 units / pallet



Right unit  
12 units / pallet

	Imperial	Metric
Product dimension (L x D x H) <b>A</b>	23 1/4 x 2 3/4 x 5 7/8	590 x 70 x 150
Product dimension (L x D x H) <b>B</b>	23 1/4 x 2 3/4 x 5 7/8	590 x 70 x 150
Cubing	24 units	24 units
Approx. Weight	700 lbs	318 kg
Number of rows	4	
Pillar height	35 7/16 in	900 mm

The top of Fascia Panels shall not be left exposed, they must be stabilized with a structural block on top or glued to the cap.

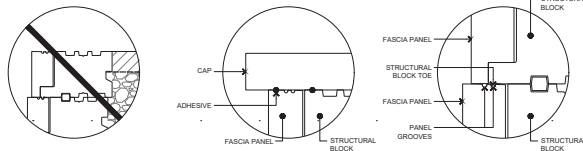

### NOTES

See page 6 for icons description.

#### COMPATIBLE CAPS

See page 145 for product compatibility.

See page 146 to 161 for more technical information.

Fascia Panels require single-sided structural blocks (retaining wall application) or double-sided structural blocks (freestanding walls).  
Sold Separately.



## ROSEMONT Fascia wall collection

**DESCRIPTION:** Fascia Panel & Corner **TEXTURE:** Klean-Bloc Slate



### FASCIA

#### Specifications per pallet

	Imperial	Metric
 Product dimension (L x D x H)	26 x 2 3/4 x 5 7/8	660 x 70 x 150
42 units / pallet	42 units	42 units
Cubing	44.75 ft <sup>2</sup>	4.16 m <sup>2</sup>
	90.94 lin. ft	27.72 lin. m
Approx. Weight	1 240 lbs	562 kg
Number of rows	7	
Coverage per row	6.39 ft <sup>2</sup>	0.60 m <sup>2</sup>
Linear coverage per row	13.03 lin. ft	3.96 lin. m

### CORNER

#### Specifications per pallet

	Imperial	Metric
 Product dimension (L x D x H) <b>A</b>	23 1/4 x 2 3/4 x 5 7/8	590 x 70 x 150
 Product dimension (L x D x H) <b>B</b>	23 1/4 x 2 3/4 x 5 7/8	590 x 70 x 150
Cubing	24 units	24 units
Approx. Weight	660 lbs	299 kg
Number of rows	4	
Pillar height	35 7/16 in	900 mm

Left unit  
12 units / pallet

Right unit  
12 units / pallet

#### Pallet Overview - panels

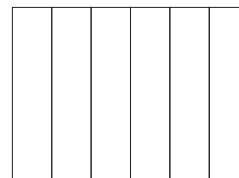

#### Pallet Overview - corners

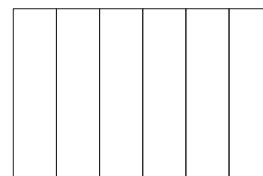

The top of Fascia Panels shall not be left exposed, they must be stabilized with a structural block on top or glued to the cap.

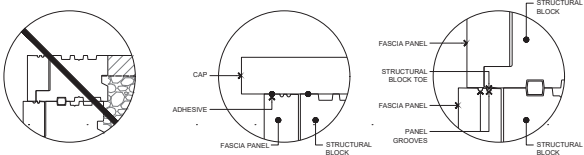

Rock Garden Brown

Klean-Bloc  
Slate



Riviera

Klean-Bloc  
Slate



Azzurro

Klean-Bloc  
Slate

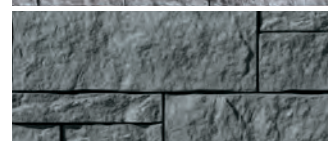

### NOTES

See page 6 for icons description.

#### COMPATIBLE CAPS

See page 145 for product compatibility.

See page 146 to 161 for more technical information.

Fascia Panels require single-sided structural blocks (retaining wall application) or double-sided structural blocks (freestanding walls).  
Sold Separately.

# INSTALLATION GUIDE

## FREESTANDING WALL

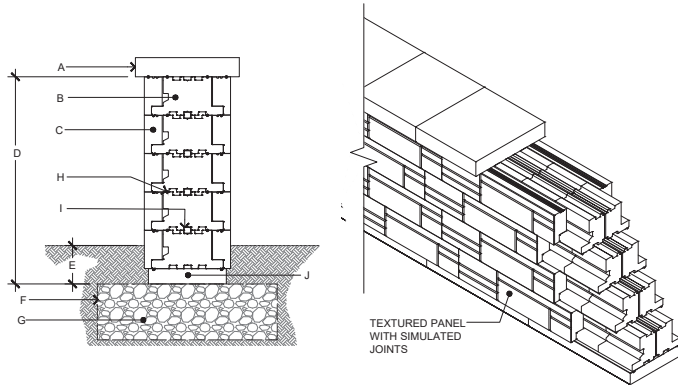

- A. TECO-BLOC CAP UNIT SECURED TO CORE AND PANEL BELOW WITH CONCRETE ADHESIVE
- B. STRUCTURAL BLOCK DOUBLE-SIDED UNIT
- C. PANEL UNIT
- D. 29 1/2" (750 mm) MAX.
- E. EMBEDMENT DEPTH 6" (150 mm) MIN.
- F. GEOTEXTILE
- G. COMPACTED GRANULAR BASE 6" (150 mm) MIN. THICKNESS ACCORDING TO PROJECT SPECIFICATIONS
- H. CONCRETE ADHESIVE
- I. HDPE HORIZONTAL KEY
- J. BASE UNIT

## FREESTANDING WALL - 90° CORNER

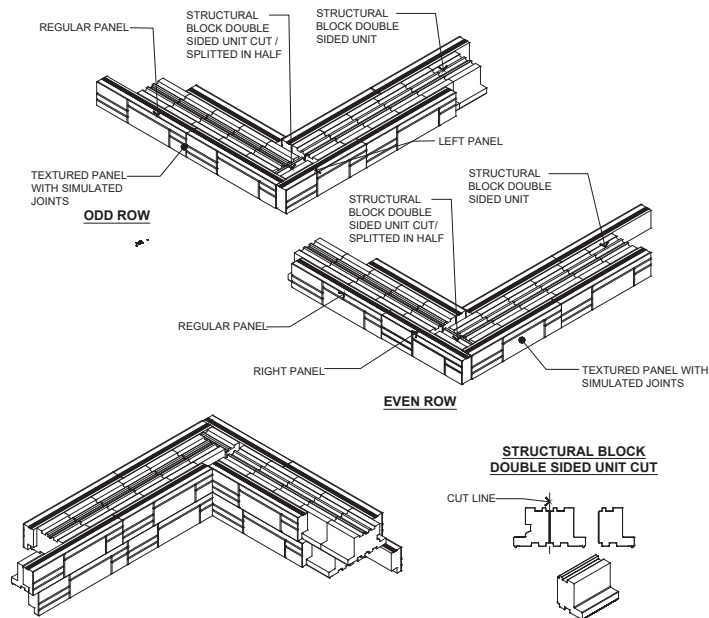

1. ALTERNATE ODD AND EVEN ROWS.
2. STAGGER STRUCTURAL BLOCKS JOINTS FROM ONE ROW TO THE NEXT.
3. GLUE ALL STRUCTURAL BLOCKS AT EACH ROW WITH CONCRETE ADHESIVE.
4. APPLY CONCRETE ADHESIVE ON TOP OF UPPERMOST PANEL UNITS TO FIX CAP UNITS.
5. STRUCTURAL BLOCK DOUBLE SIDED UNIT CUT / SPLITTED IN HALF MUST ALWAYS BE PRESENT AT THE CORNER OF THE WALL.

**NOTE:**

The top of Fascia Panels shall not be left exposed, they must be stabilized with a structural block on top or glued to the cap.

## GRAVITY RETAINING WALL

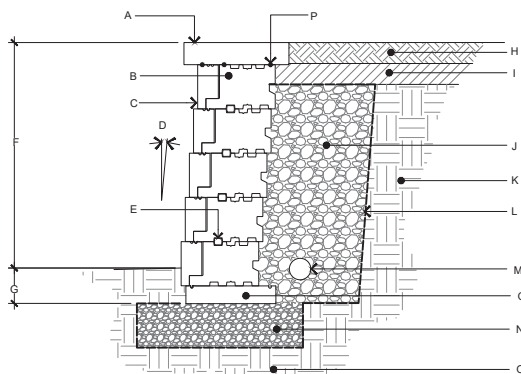

- A. TECO-BLOC CAP UNIT SECURED TO UNIT BELOW WITH CONCRETE ADHESIVE
- B. STRUCTURAL BLOCK SINGLE SIDED UNIT
- C. PANEL UNIT
- D. WALL INCLINATION (5.3°)
- E. HDPE HORIZONTAL KEY
- F. EXPOSED HEIGHT
- G. EMBEDMENT DEPTH
- H. TOP SOIL
- I. LOW PERMEABILITY SOIL
- J. 3/4" (20 mm) CLEAN STONE 14" (350mm) THICK MIN.
- K. RETAINED SOIL
- L. GEOTEXTILE
- M. PERFORATED DRAIN
- N. LEVELING PAD
- O. FOUNDATION SOIL
- P. CONCRETE ADHESIVE
- Q. BASE UNIT

# INSTALLATION GUIDE

## FREESTANDING END OF A STRAIGHT WALL (OPTION 1)

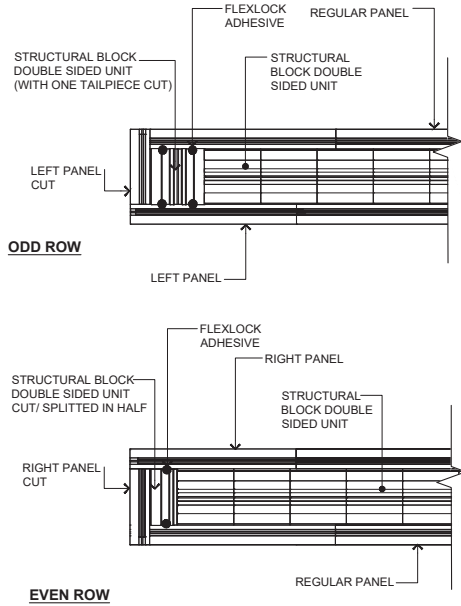

- NOTES:
1. ALTERNATE ODD AND EVEN ROWS.
  2. STAGGER STRUCTURAL BLOCKS JOINTS FROM ONE ROW TO THE NEXT.
  3. GLUE ALL STRUCTURAL BLOCKS AT EACH ROW WITH FLEXLOCK ADHESIVE.
  4. APPLY FLEXLOCK ADHESIVE ON TOP OF UPPERMOST PANEL UNITS TO FIX CAP UNITS.

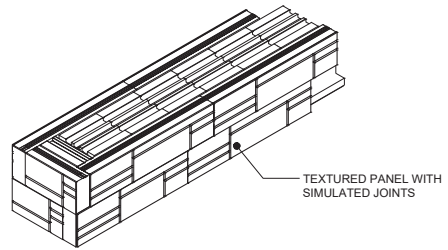

**NOTE:**  
The top of Fascia Panels shall not be left exposed, they must be stabilized with a structural block on top or glued to the cap.

## FREESTANDING END OF A STRAIGHT WALL (OPTION 2)

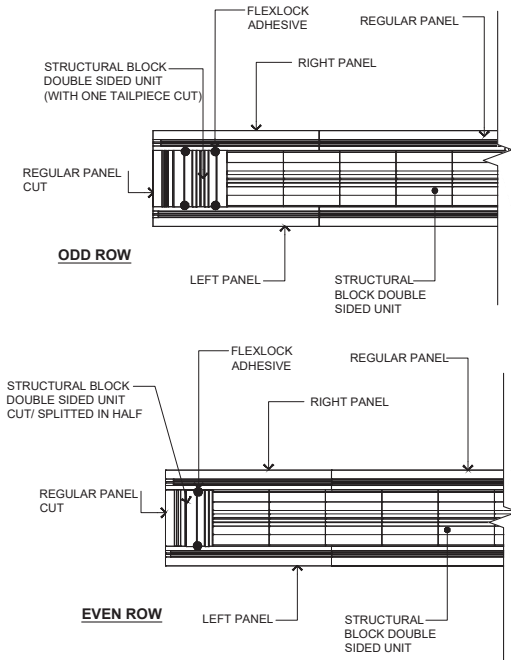

- NOTES:
1. ALTERNATE ODD AND EVEN ROWS.
  2. STAGGER STRUCTURAL BLOCKS JOINTS FROM ONE ROW TO THE NEXT.
  3. GLUE ALL STRUCTURAL BLOCKS AT EACH ROW WITH FLEXLOCK ADHESIVE.
  4. APPLY FLEXLOCK ADHESIVE ON TOP OF UPPERMOST PANEL UNITS TO FIX CAP UNITS.

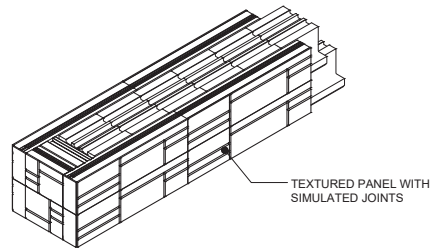

# INSTALLATION GUIDE

## PILLARS - FASCIA WALL COLLECTION

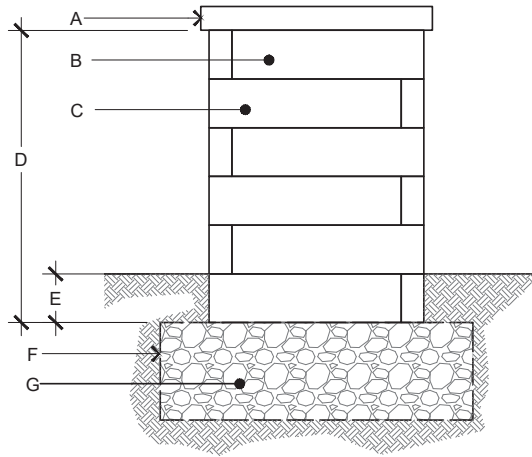

### STRUCTURAL BLOCK SINGLE SIDED UNIT CUT / SPLITTED IN HALF

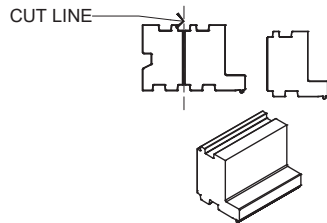

- A. PILLAR CAP UNIT SECURED TO CORE AND PANEL BELOW WITH CONCRETE ADHESIVE
- B. RIGHT PANEL
- C. LEFT PANEL
- D. 35 7/8" (900 mm) MAX HEIGHT
- E. EMBEDMENT DEPTH 6" (150 mm) MIN.
- F. GEOTEXTILE
- G. COMPACTED GRANULAR BASE 6" (150 mm) MIN. THICKNESS ACCORDING TO PROJECT SPECIFICATIONS.

**NOTE:**

The top of Fascia Panels shall not be left exposed, they must be stabilized with a structural block on top or glued to the cap

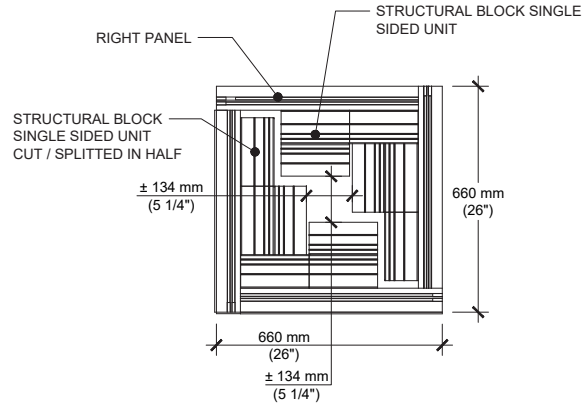

**ODD ROW**

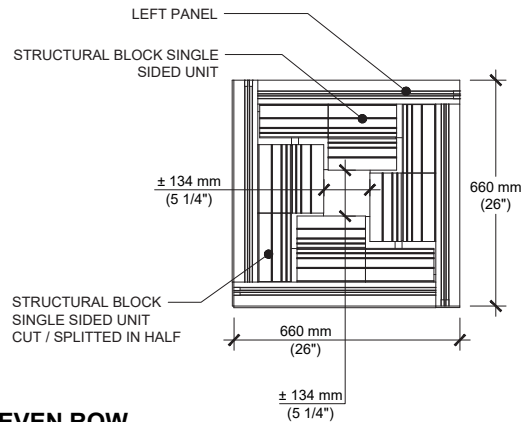

**EVEN ROW**

IIN.

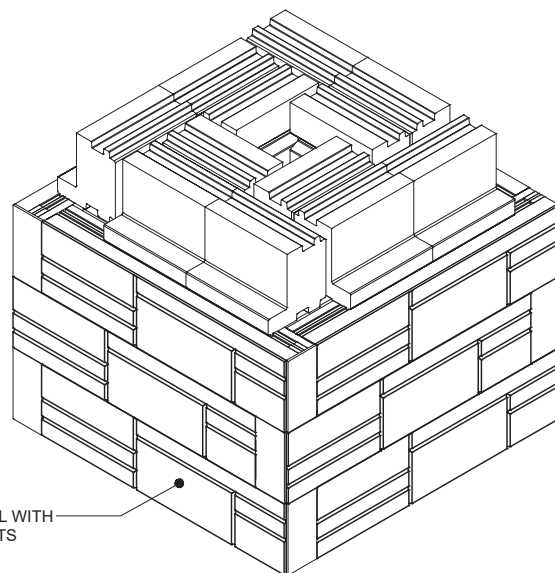

TEXTURED PANEL WITH SIMULATED JOINTS

For all possible combinations of pillars and caps, please refer to the correspondence table on page 145

# INSTALLATION GUIDE

## STEPS - FASCIA WALL COLLECTION

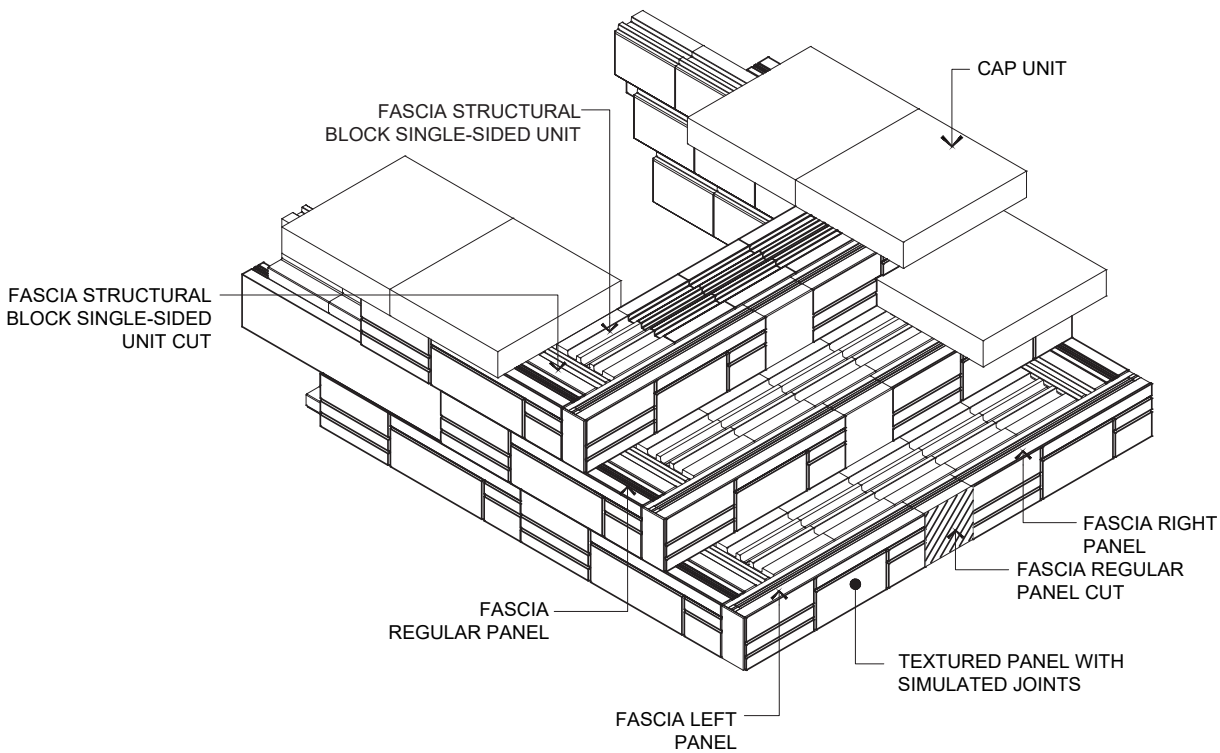
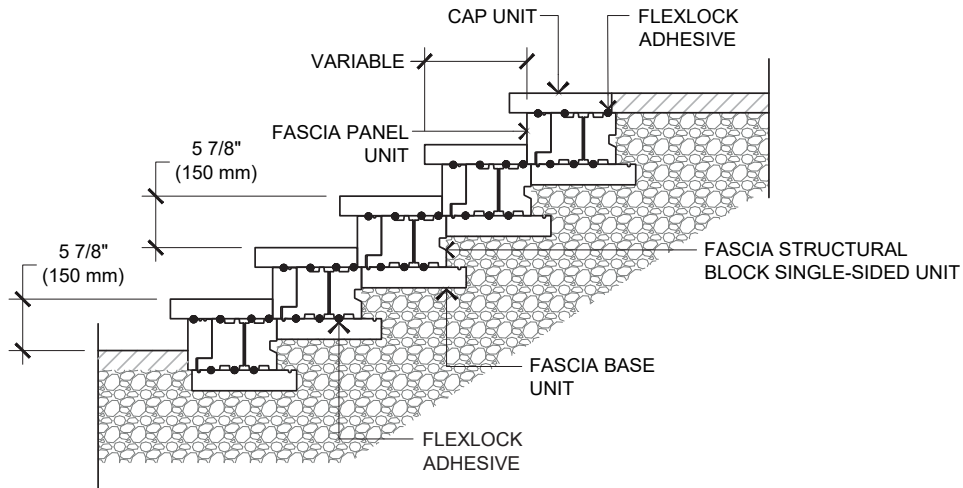

### NOTE:

The top of Fascia Panels shall not be left exposed, they must be stabilized with a structural block on top or glued to the cap

Check with your local Building Codes to determine any restrictions or guidelines regarding the dimensions of steps (including riser height and step tread) as well as handrail specifications.

D ❄️

# G-FORCE

DESCRIPTION: Wall TEXTURE: Smooth

## Pallet Overview

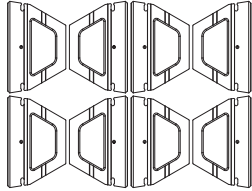

## Specifications per pallet



32 units / pallet

	Imperial	Metric
Dimension Front (L x D x H)	18 x 11 7/16 x 8	457 x 290 x 203
Dimension Back (L x D x H)	8 5/8 x 11 7/16 x 8	219 x 290 x 203
Cubing	32.00 ft <sup>2</sup>	2.97 m <sup>2</sup>
	48 lin. ft	14.63 lin. m
Approx. Weight	2 477 lbs	1 124 kg
Number of rows	4	
Coverage per row	8.00 ft <sup>2</sup>	0.74 m <sup>2</sup>
Linear coverage per row	12.00 lin. ft	3.66 lin. m



Smooth  
Chestnut Brown

Smooth  
Champlain Grey

Smooth  
Shale Grey

## NOTES

See page 6 for icons description.

### COMPATIBLE CAPS

See page 145 for product compatibility.

G-Force block can be installed in a setback position only (inclined wall). The positioning of the HDPE key does not allow for a vertical installation.

Geogrid positioning: visit our website for geogrid design charts

See page 146 to 161 for more technical information.



D ❄️

## G-FORCE Corner unit

DESCRIPTION: Wall TEXTURE: Smooth

Specifications per pallet	Imperial	Metric
 16 units / pallet	Product dimension (L×D×H)	18 × 9 × 8
	Cubing	16 units
	Approx. Weight	1 654 lbs
Number of rows	2	750 kg

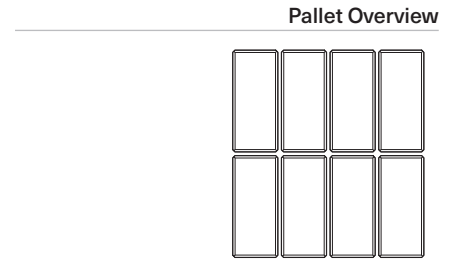

### NOTES

See page 6 for icons description.

#### COMPATIBLE CAPS

See page 145 for product compatibility.

See page 146 to 161 for more technical information.

CLEAN SAND/GRAVEL/ SAND AND GRAVEL MIXES ( $\phi=34^\circ$ ,  $\gamma = 120$  pcf)  
 GEOGRID: MIRAGRID 3XT BY TENCATE (RFd=1.10, RFcr=1.45, RFid=1.25, Cds=0.9, Ci=0.9)

**CASE N° 1 :**  
 No Surcharge  
 No Backslope  
 No Toe Slope

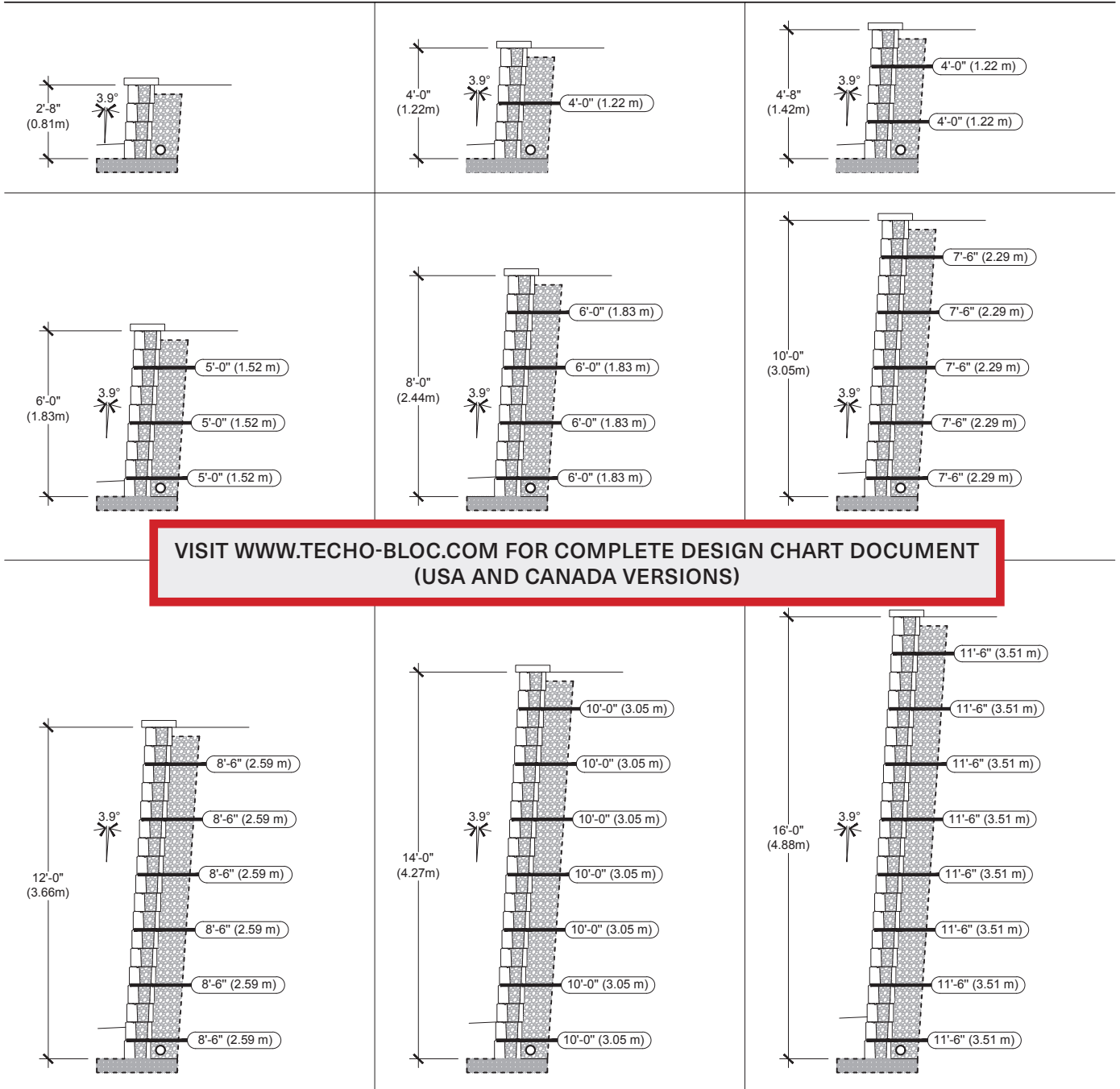

**VISIT [WWW.TECHO-BLOC.COM](http://WWW.TECHO-BLOC.COM) FOR COMPLETE DESIGN CHART DOCUMENT  
(USA AND CANADA VERSIONS)**

1. The information contained in the design charts is supplied for information purposes only and as such should only be used for preliminary designs.
2. The height (H) of the wall is the total height from the leveling pad to the top of the wall not including the thickness of the cap.
3. Soil parameters: reinforced soil ( $\phi = 34^\circ$ ,  $\gamma = 120$  pcf); retained soil ( $\phi = 34^\circ$ ,  $\gamma = 120$  pcf); foundation soil ( $\phi = 34^\circ$ ,  $\gamma = 120$  pcf)
4. A qualified engineer should be consulted for the final design to be used for construction.
5. The foundation soil must be able to support the wall system. The bearing capacity of the foundation soil, settlement, and global stability must be verified and validated by a qualified geotechnical engineer.
6. The seismic analysis is not included.
7. The design charts do not apply to tiered walls.
8. The charts assume that the walls are constructed in accordance with Techo-Bloc specifications, good construction practice and an adequate drainage system.
9. The geogrid layout has been optimized to satisfy the design requirements of the NCMA's Design Manual for Segmental Retaining Walls, 3rd Edition.
10. The minimum burial depth must be 6 in (150 mm) or 10% of the exposed height, whichever is greater.
11. Engineering judgement should be used when interpolating between heights.
12. Techo-Bloc and its predecessors, successors, beneficiaries, employees, associates, administrators and insurers accepts no liability for the incorrect use of information contained in the design charts.
13. For further information, please contact our technical service department.

# INSTALLATION GUIDE

## GRAVITY AND REINFORCED WALLS - G-FORCE

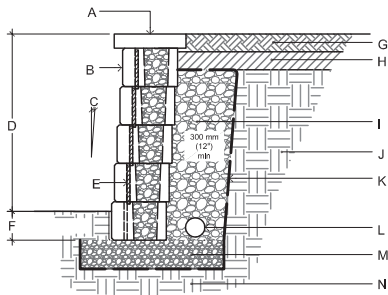

GRAVITY WALL DETAIL

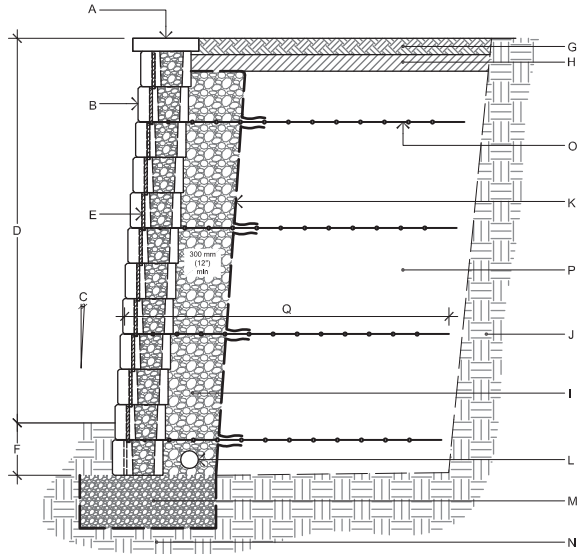

REINFORCED WALL DETAIL

- A. CAP FROM TECO-BLOC
- B. G-FORCE BLOCK FROM TECO-BLOC
- C. WALL INCLINATION (3.9°)
- D. EXPOSED HEIGHT
- E. HDPE VERTICAL KEY
- F. EMBEDMENT DEPTH
- G. TOP SOIL
- H. LOW PERMEABILITY SOIL
- I. ¾" (20 mm) CLEAN STONE

- J. RETAINED SOIL
- K. GEOTEXTILE
- L. PERFORATED DRAIN
- M. LEVELING PAD
- N. FOUNDATION SOIL
- O. GEOGRID
- P. REINFORCED SOIL
- Q. GEOGRID LENGTH

## STEPS - G-FORCE

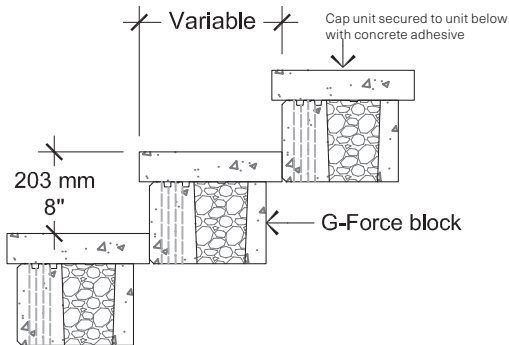

For all possible combinations of pillars and caps, please refer to the correspondence table on page 145

Check with your local Building Codes to determine any restrictions or guidelines regarding the dimensions of steps (including riser height and step tread) as well as handrail specifications.

# INSTALLATION GUIDE

## PILLARS - G-FORCE

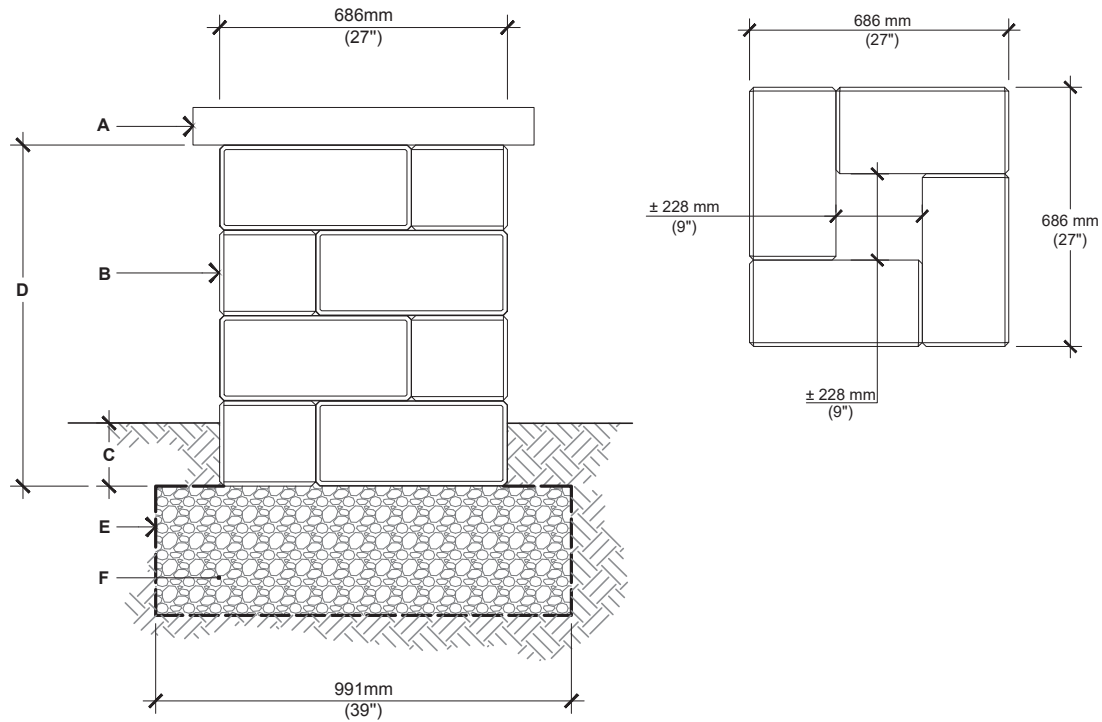

### G-FORCE PILLAR







- A.** PILLAR CAP UNIT  
(SECURE WITH CONCRETE ADHESIVE)
- B.** G-FORCE UNIT SECURE EACH ROW WITH  
CONCRETE ADHESIVE
- C.** EMBEDMENT 6" (150 mm) MIN.
- D.** 32" (813 mm) HEIGHT PER PALLET  
48" (1219 mm), MAX. HEIGHT
- E.** GEOTEXTILE
- F.** COMPACTED GRANULAR BASE 6"  
(150 mm THICK MIN. THICKNESS ACCORDING  
TO PROJECT SPECIFIC CONDITIONS)

For all possible combinations of pillars and caps, please refer to the correspondence table on page 145

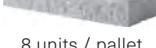

# GRAPHIX

**DESCRIPTION:** Wall double-sided **TEXTURE:** Smooth & Split face

Specifications per pallet		Imperial	Metric
<b>1</b>	 8 units / pallet	Product dimension (L×D×H) <b>1</b> 20 × 9 1/16 × 2 15/16	508 × 230 × 75
		Product dimension (L×D×H) <b>2</b> 20 × 10 1/16 × 2 15/16	508 × 255 × 75
		Product dimension (L×D×H) <b>3</b> 20 × 11 × 2 15/16	508 × 280 × 75
<b>2</b>	 8 units / pallet	Product dimension (L×D×H) <b>4</b> 20 × 8 1/16 × 2 15/16	508 × 205 × 75
		Product dimension (L×D×H) <b>1A</b> 20 × 9 1/16 × 2 15/16	508 × 230 × 75
		Product dimension (L×D×H) <b>2A</b> 20 × 10 1/16 × 2 15/16	508 × 255 × 75
<b>3</b>	 8 units / pallet	Product dimension (L×D×H) <b>3A</b> 20 × 11 × 2 15/16	508 × 280 × 75
		Product dimension (L×D×H) <b>4A</b> 20 × 8 1/16 × 2 15/16	508 × 205 × 75
<b>4</b>	 8 units / pallet split on one side	Cubing	26.25 ft <sup>2</sup> / 2.44 m <sup>2</sup>
		107.67 lin. ft	32.51 m lin.
		Approx. Weight	2 773 lbs / 1 258 kg
		Number of rows	8
		Coverage per row	3.28 ft <sup>2</sup> / 0.30 m <sup>2</sup>
<b>1A</b>	 8 units / pallet Left corner unit	Lin. coverage per row	13.33 lin. ft / 4.06 lin. m
<b>2A</b>	 8 units / pallet Right corner unit		
<b>3A</b>	 8 units / pallet Left corner unit		
<b>4A</b>	 8 units / pallet Right corner unit, split on one side		

## Pallet Overview

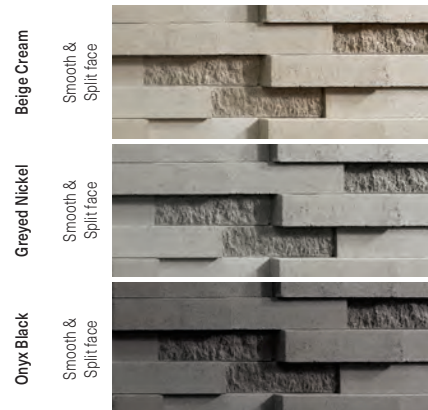
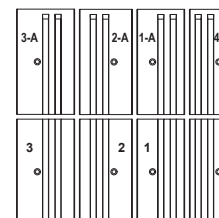

## NOTES

See page 6 for icons description.

### COMPATIBLE CAPS

See page 145 for product compatibility.

See page 146 to 161 for more technical information.

CLEAN SAND/GRAVEL/ SAND AND GRAVEL MIXES ( $\phi=34^\circ$ ,  $\gamma = 120$  pcf)  
GEOGRID: MIRAGRID 2XT BY TENCATE (RFd=1.10, RFcr=1.45, RFid=1.25, Cds=0.9, Ci=0.9)

**CASE N° 1 :**  
No Surcharge  
No Backslope  
No Toe Slope

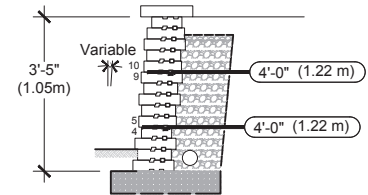
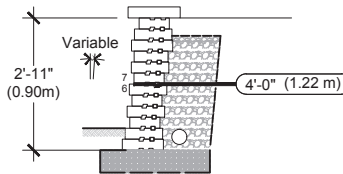
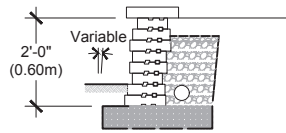

VISIT [WWW.TECHO-BLOC.COM](http://WWW.TECHO-BLOC.COM) FOR COMPLETE DESIGN CHART DOCUMENT  
(USA AND CANADA VERSIONS)

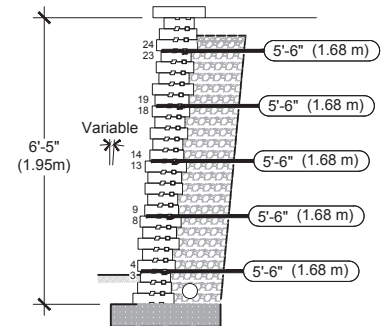
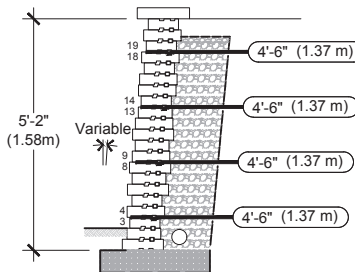
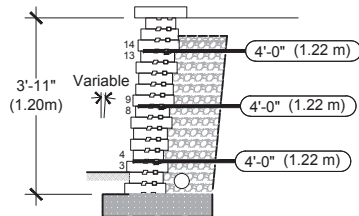

1. The information contained in the design charts is supplied for information purposes only and as such should only be used for preliminary designs.
2. The height (H) of the wall is the total height from the leveling pad to the top of the wall not including the thickness of the cap.
3. Soil parameters: reinforced soil ( $\phi = 34^\circ$ ,  $\gamma = 120$  pcf); retained soil ( $\phi=34^\circ$ ,  $\gamma = 120$  pcf); foundation soil ( $\phi=34^\circ$ ,  $\gamma = 120$  pcf)
4. A qualified engineer should be consulted for the final design to be used for construction.
5. The foundation soil must be able to support the wall system. The bearing capacity of the foundation soil, settlement, and global stability must be verified and validated by a qualified geotechnical engineer.
6. The seismic analysis is not included.
7. The design charts do not apply to tiered walls.
8. The charts assume that the walls are constructed in accordance with Techo-Bloc specifications, good construction practice and an adequate drainage system.
9. The geogrid layout has been optimized to satisfy the design requirements of the NCMA's Design Manual for Segmental Retaining Walls, 3rd Edition.
10. The minimum burial depth must be 6 in (150 mm) or 10% of the exposed height, whichever is greater.
11. Engineering judgement should be used when interpolating between heights.
12. Techo-Bloc and its predecessors, successors, beneficiaries, employees, associates, administrators and insurers accepts no liability for the incorrect use of information contained in the design charts.
13. For further information, please contact our technical service department.

# INSTALLATION GUIDE

## FREESTANDING WALLS - GRAPHIX

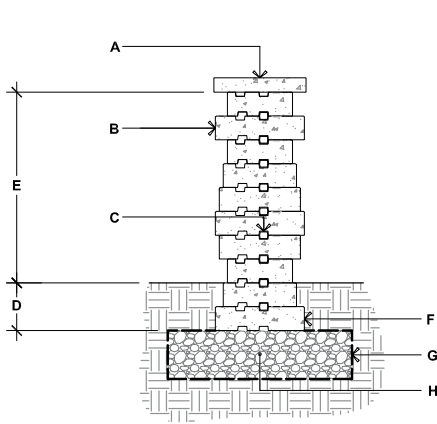

### GRAPHIX

- A.** TECO-BLOC CAP UNIT SECURED TO UNIT BELOW WITH CONCRETE ADHESIVE
- B.** GRAPHIX DOUBLE-SIDED WALL UNITS SECURE EACH ROW WITH CONCRETE ADHESIVE
- C.** CONNECTOR
- D.** EMBEDMENT DEPTH, 6" (150 mm) MIN.
- E.** 23 1/2" (600 mm) MAX.
- F.** FOR THE FIRST ROW, ALWAYS USE THE DEEPER GRAPHIX BLOCK
- G.** GEOTEXTILE
- H.** COMPACTED GRANULAR LEVELING PAD, 6" (150 mm) THICK MIN. THICKNESS ACCORDING TO PROJECT SPECIFIC CONDITIONS

## 90° CORNER OF A DOUBLE-SIDED WALL

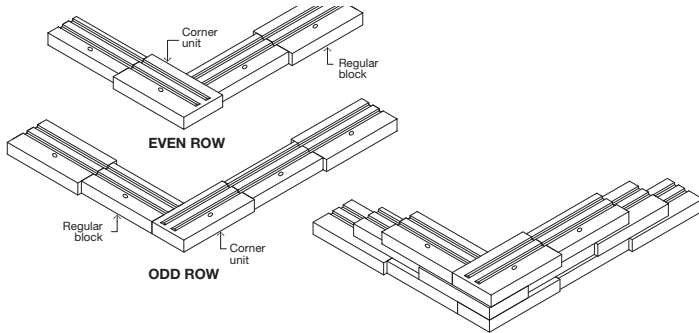

1. Alternate odd and even rows.
2. Stagger joints from one row to the next.
3. Glue all modules at each row with concrete adhesive.
4. Connectors are not illustrated to avoid overloading the image.
5. It is possible to alternate the blocks (1, 2, 3 or 4) in the same row to create different patterns. However, a corner block (1A, 2A, 3A or 4A) must always be present at the end of a row and must be alternated for each subsequent row.
6. At the corner, make sure to place the blocks so that the grooves of the block cannot be seen.

## DOUBLE-SIDED WALL - END OF A STRAIGHT WALL

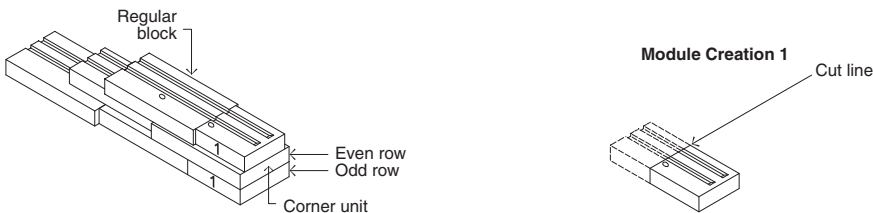

\* It is possible to alternate the blocks (1, 2, 3 or 4) in the same row to create different patterns. However, a corner block and a cut corner block (1A, 2A, 3A or 4A) must always be present at the end of a row and must be alternated for each subsequent row.

# INSTALLATION GUIDE

## PILLARS - GRAPHIX

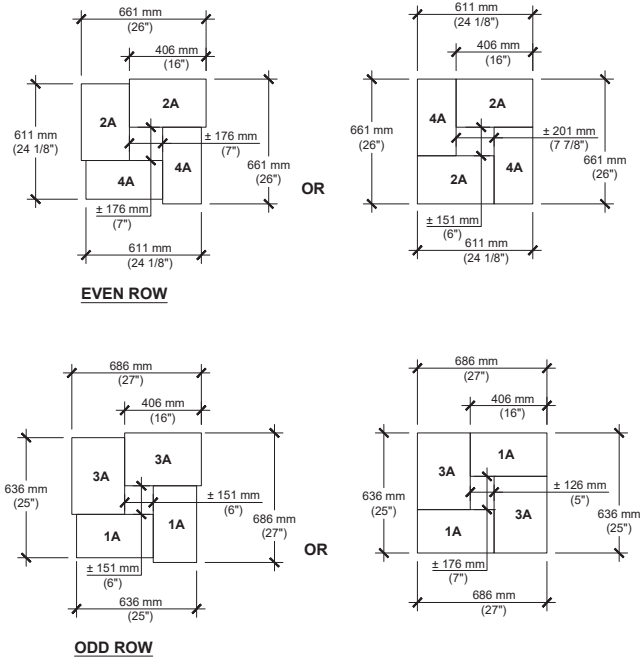
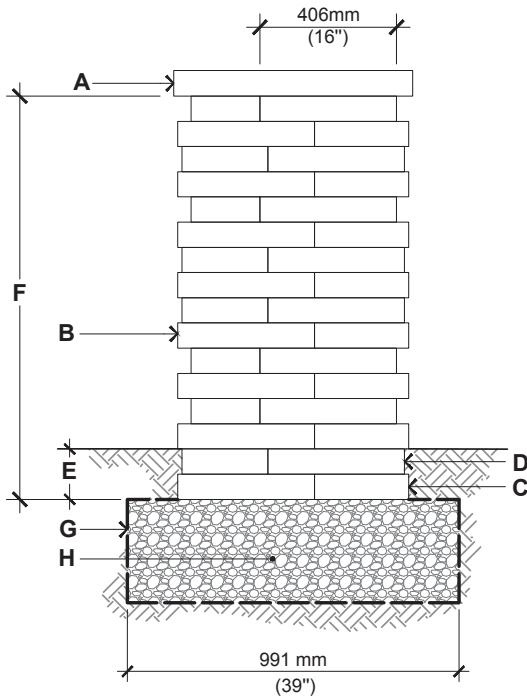

- NOTES:
- ALL UNITS MUST BE CUT ON FIELD
  - USE A CHISEL FOR DESIRED SPLITTED TEXTURE FACE

### GRAPHIX

- A.** PILLAR CAP UNIT (SECURE WITH CONCRETE ADHESIVE)
- B.** GRAPHIX CORNER UNIT  
SECURE EACH ROW WITH CONCRETE ADHESIVE  
CUT EACH BLOCK AT 16" (406 mm) FROM THE CORNER EDGE
- C.** USE THE BLOCKS 1A-3A FOR THE ODD ROWS
- D.** USE THE BLOCKS 2A-4A FOR THE EVEN ROWS
- E.** EMBEDMENT DEPTH 6" (150 mm) MIN.
- F.** 23 5/8" (600 mm) HEIGHT PER PALLET  
47 1/4" (1200 mm) MAXIMUM HEIGHT
- G.** GEOTEXTILE
- H.** COMPACTED GRANULAR BASE 6" (150 mm) THICK MIN.  
THICKNESS ACCORDING TO PROJECT SPECIFIC CONDITIONS

For all possible combinations of pillars and caps, please refer to the correspondence table on page 145







# MINI-CRETA 3" Architectural

DESCRIPTION: Wall double-sided TEXTURE: Split face with straight edged corners

D 

PATENT  
CND 2,114,677  
US 5,528,873 P

Specifications per pallet		Imperial	Metric
<b>A</b> 	Dimension Front (L x D x H) <b>A</b>	9 1/16 x 9 13/16 x 2 15/16	230 x 250 x 75
	Dimension Back (L x D x H) <b>A</b>	7 1/16 x 9 13/16 x 2 15/16	180 x 250 x 75
32 units / pallet	Dimension Front (L x D x H) <b>B</b>	11 13/16 x 9 13/16 x 2 15/16	300 x 250 x 75
	Dimension Back (L x D x H) <b>B</b>	9 13/16 x 9 13/16 x 2 15/16	250 x 250 x 75
<b>B</b> 	Dimension Front (L x D x H) <b>B*</b>	11 13/16 x 9 13/16 x 2 15/16	300 x 250 x 75
	Dimension Back (L x D x H) <b>B*</b>	11 13/16 x 9 13/16 x 2 15/16	300 x 250 x 75
24 units / pallet	Dimension Front (L x D x H) <b>C</b>	14 3/4 x 9 13/16 x 2 15/16	375 x 250 x 75
	Dimension Back (L x D x H) <b>C</b>	12 13/16 x 9 13/16 x 2 15/16	325 x 250 x 75
<b>B*</b> 	Dimension Front (L x D x H) <b>D</b>	14 3/4 x 9 13/16 x 2 15/16	375 x 250 x 75
	Dimension Back (L x D x H) <b>D</b>	13 3/4 x 9 13/16 x 2 15/16	350 x 250 x 75
8 units / pallet	Cubing	24 ft <sup>2</sup>	2.23 m <sup>2</sup>
	Approx. Weight	2 465 lbs	1 118 kg
<b>C</b> 	Minimum radius	7 ft	2.1 m
	Number of rows	8	
<b>D</b> 	Coverage per row	3 ft <sup>2</sup>	0.28 m <sup>2</sup>
	Lin. coverage per row	11.88 lin. ft	3.62 lin. m

## Pallet Overview

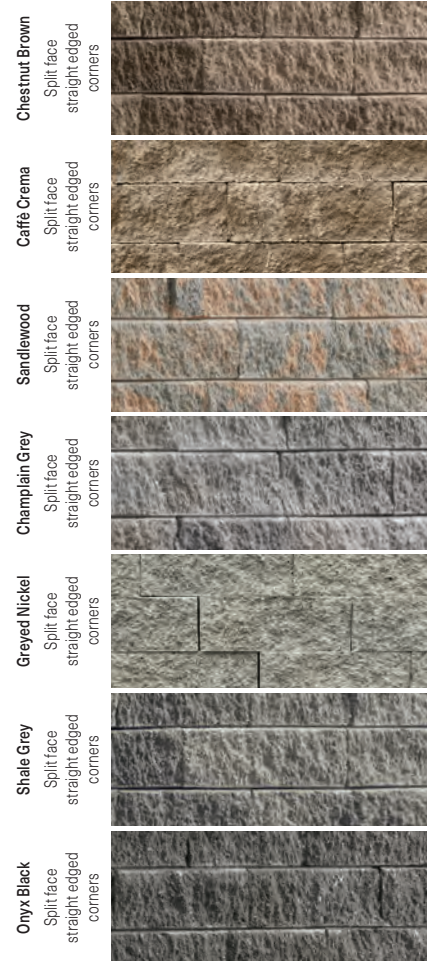
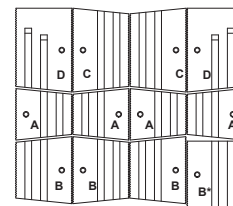

## NOTES

### COMPATIBLE CAPS

See page 6 for icons description.

See page 145 for product compatibility.

When building a double-sided wall one pallet will cover an average of 21.76 ft<sup>2</sup>.

**B\*** unit can be used as a regular or vertical unit.

See page 146 to 161 for more technical information.



**P** PATENT  
CND 2,114,677  
US 5,528,873

# MINI-CRETA 6" Architectural

**DESCRIPTION:** Wall double-sided **TEXTURE:** Split face with straight edged corners

## Pallet Overview

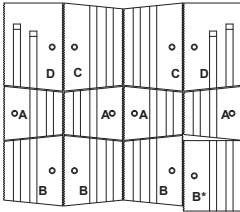

Split face  
straight edged  
corners  
**Chestnut Brown**

Split face  
straight edged  
corners  
**Caffè Crema**

Split face  
straight edged  
corners  
**Sandlewood**

Split face  
straight edged  
corners  
**Champlain Grey**

Split face  
straight edged  
corners  
**Greyed Nickel**

Split face  
straight edged  
corners  
**Shale Grey**

## Specifications per pallet



20 units / pallet



15 units / pallet



5 units / pallet



10 units / pallet



10 units / pallet

5 right corners  
5 left corners

	Imperial	Metric
Dimension Front (L x D x H) <b>A</b>	9 1/16 x 9 13/16 x 5 7/8	230 x 250 x 150
Dimension Back (L x D x H) <b>A</b>	7 1/16 x 9 13/16 x 5 7/8	180 x 250 x 150
Dimension Front (L x D x H) <b>B</b>	11 13/16 x 9 13/16 x 5 7/8	300 x 250 x 150
Dimension Back (L x D x H) <b>B</b>	9 13/16 x 9 13/16 x 5 7/8	250 x 250 x 150
Dimension Front (L x D x H) <b>B*</b>	11 13/16 x 9 13/16 x 5 7/8	300 x 250 x 150
Dimension Back (L x D x H) <b>B*</b>	11 13/16 x 9 13/16 x 5 7/8	300 x 250 x 150
Dimension Front (L x D x H) <b>C</b>	14 3/4 x 9 13/16 x 5 7/8	375 x 250 x 150
Dimension Back (L x D x H) <b>C</b>	12 13/16 x 9 13/16 x 5 7/8	325 x 250 x 150
Dimension Front (L x D x H) <b>D</b>	14 3/4 x 9 13/16 x 5 7/8	375 x 250 x 150
Dimension Back (L x D x H) <b>D</b>	13 3/4 x 9 13/16 x 5 7/8	350 x 250 x 150
Cubing	30 ft <sup>2</sup>	2.79 m <sup>2</sup>
Approx. Weight	59.38 lin. ft	18.10 lin. m
Minimum radius	3 086lbs	1 400 kg
Number of rows	7 ft	2.1 m
Coverage per row	5	
Lin. coverage per row	6 ft <sup>2</sup>	0.56 m <sup>2</sup>
	11.88 lin. ft	3.62 lin. m

## NOTES

See page 6 for icons description.

### COMPATIBLE CAPS

See page 145 for product compatibility.

When building a double-sided wall one pallet will cover an average of 27.21 ft<sup>2</sup>.

**B\*** unit can be used as a regular or vertical unit.

See page 146 to 161 for more technical information.



## PILLAR 24" Mini-Creta Architectural

**DESCRIPTION:** Pillar **TEXTURE:** Split face with straight edged corners

### PILLAR 24" × 6"

Specifications per pallet		Imperial	Metric
	Product dimension (L × D × H)	16 × 8 × 5 7/8	406 × 203 × 150
	Cubing	24 units	24 units
	Approx. Weight	1 510 lbs	685 kg
24 units / pallet	Number of rows	3	
	Pillar height	35 7/8 in	900 mm

### Pallet Overview

			A

**Chestnut Brown**  
Split face  
straight edged  
corners



**Caribé Crema**  
Split face  
straight edged  
corners

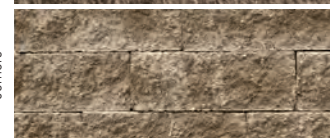

**Sandlewood**  
Split face  
straight edged  
corners

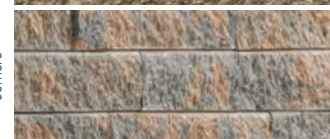

**Champlain Grey**  
Split face  
straight edged  
corners



**Greyed Nickel**  
Split face  
straight edged  
corners



**Shale Grey**  
Split face  
straight edged  
corners



### NOTES

See page 6 for icons description.

#### COMPATIBLE CAPS

See page 145 for product compatibility.

See page 146 to 161 for more technical information.

# TECHO—BLOC

## DESIGN CHART MINI-CRETA 6"

(EQUIVALENT TO TWICE THE MINI-CRETA 3")  
SETBACK POSITION

CLEAN SAND/GRAVEL/ SAND AND GRAVEL MIXES ( $\phi=34^\circ$ ,  $\gamma = 120$  pcf)  
GEOGRID: MIRAGRID 3XT BY TENCATE (RFd=1.10, RFcr=1.45, RFid=1.25, Cds=0.9, Ci=0.9)

**CASE N° 1 :**  
No Surcharge  
No Backslope  
No Toe Slope

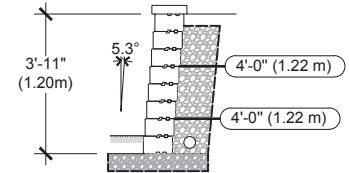
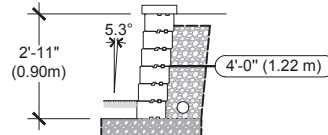
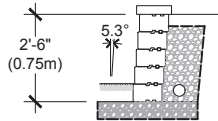

VISIT [WWW.TECHO-BLOC.COM](http://WWW.TECHO-BLOC.COM) FOR COMPLETE DESIGN CHART DOCUMENT  
(USA AND CANADA VERSIONS)

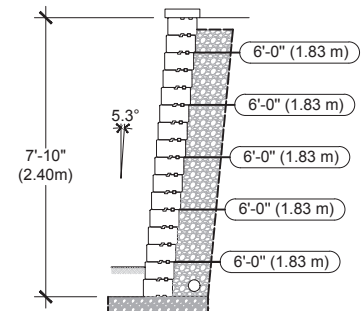
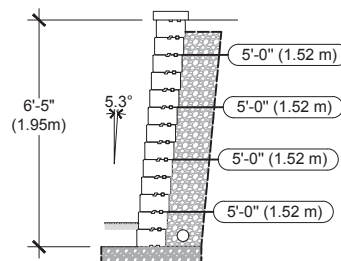
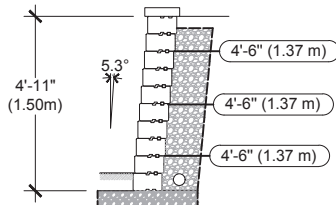

1. The information contained in the design charts is supplied for information purposes only and as such should only be used for preliminary designs.
2. The height (H) of the wall is the total height from the leveling pad to the top of the wall not including the thickness of the cap.
3. Soil parameters: reinforced soil ( $\phi = 34^\circ$ ,  $\gamma = 120$  pcf); retained soil ( $\phi = 34^\circ$ ,  $\gamma = 120$  pcf); foundation soil ( $\phi = 34^\circ$ ,  $\gamma = 120$  pcf)
4. A qualified engineer should be consulted for the final design to be used for construction.
5. The foundation soil must be able to support the wall system. The bearing capacity of the foundation soil, settlement, and global stability must be verified and validated by a qualified geotechnical engineer.
6. The seismic analysis is not included.
7. The design charts do not apply to tiered walls.
8. The charts assume that the walls are constructed in accordance with Techo-Bloc specifications, good construction practice and an adequate drainage system.
9. The geogrid layout has been optimized to satisfy the design requirements of the NCMA's Design Manual for Segmental Retaining Walls, 3rd Edition.
10. The minimum burial depth must be 6 in (150 mm) or 10% of the exposed height, whichever is greater.
11. Engineering judgement should be used when interpolating between heights.
12. Techo-Bloc and its predecessors, successors, beneficiaries, employees, associates, administrators and insurers accepts no liability for the incorrect use of information contained in the design charts.
13. For further information, please contact our technical service department.

# INSTALLATION GUIDE

## RETAINING WALLS - MINI-CRETA 3" AND 6"

The different modules of the Mini-Creta retaining wall allow the installation of different block combinations.

Twelve combinations are shown as an example. Combinations are 20 7/8" (530 mm) or 23 7/8" (605 mm) long and 8 7/8" (225 mm) high.

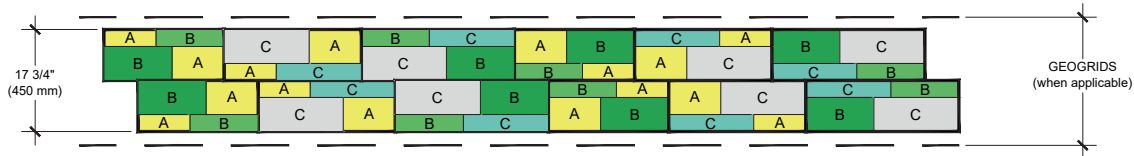
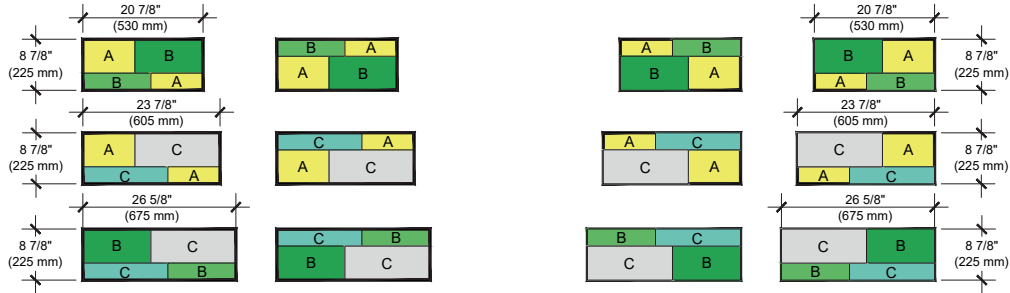

NUMBER OF BLOCKS REQUIRED

MODULE

MINI-CRETA

A

B OR B\*

C OR D

33% of the surface - Mini-Creta 3"

8

8

8

67% of the surface - Mini-Creta 6"

8

8

8

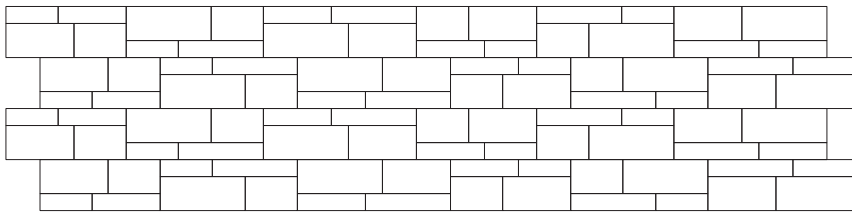

# INSTALLATION GUIDE

## FREESTANDING WALLS - MINI-CRETA 3" AND 6"

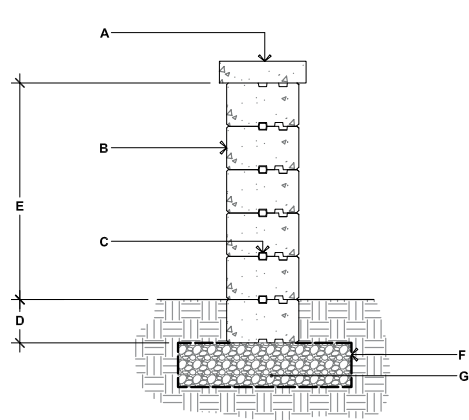

### MINI-CRETA 3" & 6"

- A. TECO-BLOC CAP UNIT SECURED TO UNIT BELOW WITH CONCRETE ADHESIVE
- B. MINI-CRETA 3" AND 6" DOUBLE-SIDED WALL UNITS SECURE EACH ROW WITH CONCRETE ADHESIVE
- C. CONNECTOR
- D. EMBEDMENT DEPTH, 6" (150 mm) MIN.
- E. 29 7/16" (750 mm) MAX.
- F. GEOTEXTILE
- G. COMPACTED GRANULAR LEVELING PAD, 6" (150 mm) THICK MIN. THICKNESS ACCORDING TO PROJECT SPECIFIC CONDITIONS

## 90° CORNER OF A DOUBLE-SIDED WALL

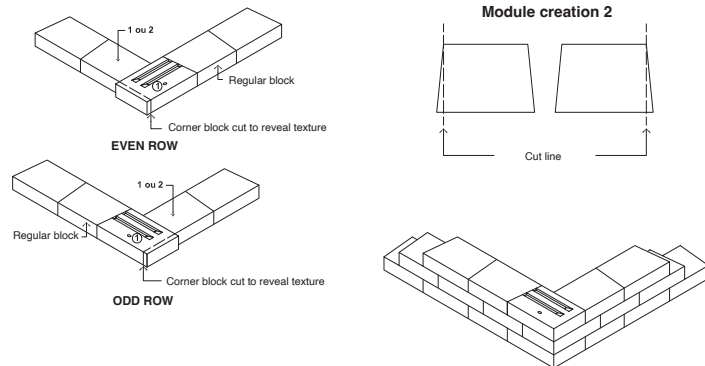

### The corner block must be cut to reveal the texture

1. Alternate odd and even rows.
2. Stagger joints from one row to the next.
3. Glue all modules at each row with concrete adhesive.
4. Cavities, grooves and connectors are not illustrated to avoid overloading the image.
5. It is possible to alternate the blocks (A, B or C) in the same row to create different patterns. However, a corner block must always be present at the end of a row and must be alternated for each subsequent row.

## DOUBLE-SIDED WALL - END OF A STRAIGHT WALL

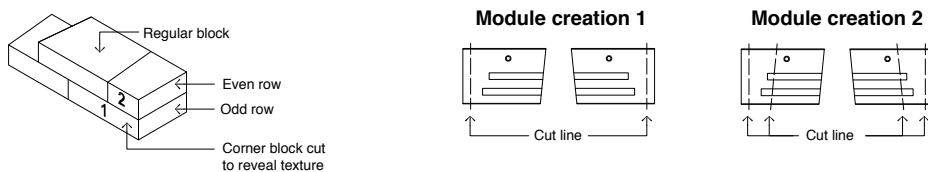

\* It is possible to alternate the blocks (A, B or C) in the same row to create different patterns. However, a corner block must always be present at the end of a row and must be alternated for each subsequent row.

# INSTALLATION GUIDE

## DOUBLE-SIDED WALL RADIUS - MINI-CRETA 3" AND 6"

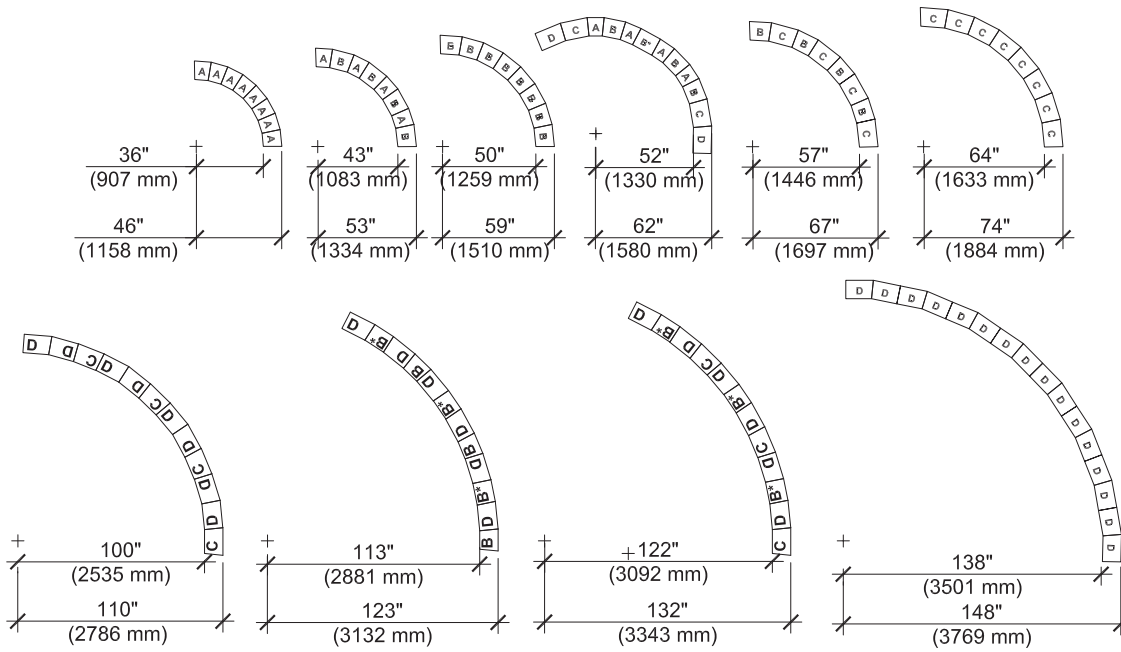

IT IS THE USER'S RESPONSIBILITY TO VERIFY FOR THE QUANTITY OF MATERIALS REQUIRED.

It is the user's responsibility to verify for the quantity of materials required.

### STEPS

#### MINI-CRETA 3"

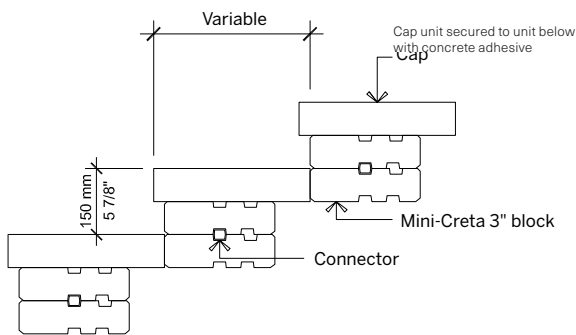

#### MINI-CRETA 6"

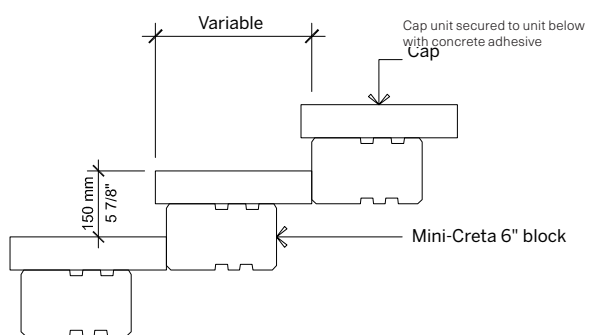

For all possible combinations of pillars and caps, please refer to the correspondence table on page 145

Check with your local Building Codes to determine any restrictions or guidelines regarding the dimensions of steps (including riser height and step tread) as well as handrail specifications.

# INSTALLATION GUIDE

## PILLARS- MINI-CRETA 3" AND 6"

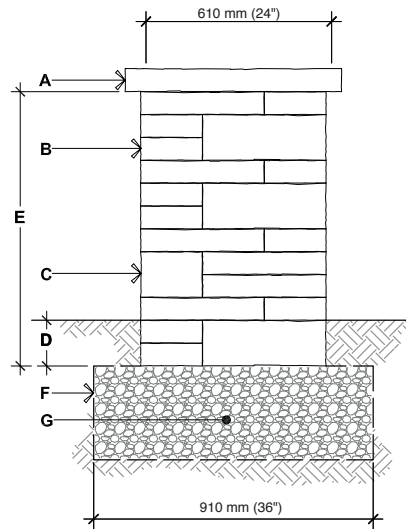
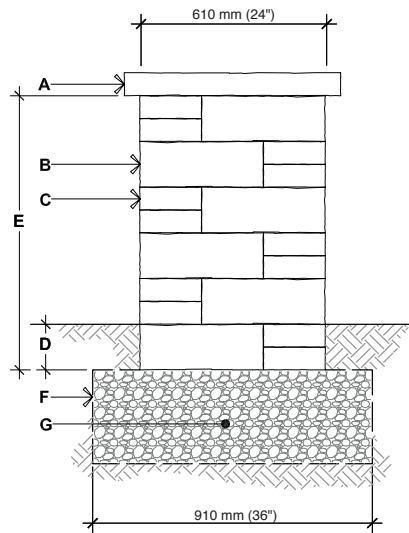

### PILLAR 24"×3" & 24"×6" MINI-CRETA - OPTION A

- A. PILLAR CAP UNIT  
(SECURE WITH CONCRETE ADHESIVE)
- B. PILLAR 24" × 6" (MINI-CRETA) UNIT  
SECURE EACH ROW WITH CONCRETE  
ADHESIVE
- C. PILLAR 24" × 3" (MINI-CRETA) UNIT SECURE  
EACH ROW WITH CONCRETE ADHESIVE
- D. EMBEDMENT 6" (150 mm) MIN.
- E. 35 <sup>7</sup>/<sub>16</sub>" (900 mm)  
47 <sup>1</sup>/<sub>4</sub>" (1200 mm), MAXIMUM HEIGHT
- F. GEOTEXTILE
- G. COMPACTED GRANULAR BASE 150 mm (6")  
THICK MIN. THICKNESS ACCORDING TO  
PROJECT SPECIFIC CONDITIONS

### PILLAR 24"×3" & 24"×6" MINI-CRETA - OPTION B

- A. PILLAR CAP UNIT  
(SECURE WITH CONCRETE ADHESIVE)
- B. PILLAR 24" × 3" (MINI-CRETA) UNIT  
SECURE EACH ROW WITH CONCRETE  
ADHESIVE
- C. PILLAR 24" × 6" (MINI-CRETA) UNIT  
SECURE EACH ROW WITH CONCRETE  
ADHESIVE
- D. EMBEDMENT 6" (150 mm) MIN.
- E. 35 <sup>7</sup>/<sub>16</sub>" (900 mm)  
47 <sup>1</sup>/<sub>4</sub>" (1200 mm), MAXIMUM HEIGHT
- F. GEOTEXTILE
- G. COMPACTED GRANULAR BASE 150 mm (6")  
THICK MIN. THICKNESS ACCORDING TO  
PROJECT SPECIFIC CONDITIONS

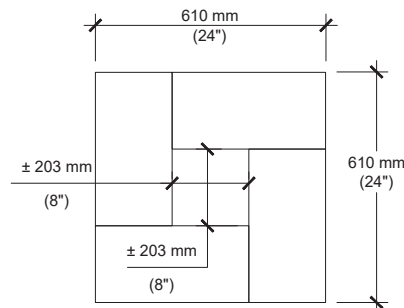

For all possible combinations of pillars and caps, please refer to the correspondence table on page 145

# INSTALLATION GUIDE

## PILLARS- MINI-CRETA 3" AND 6"

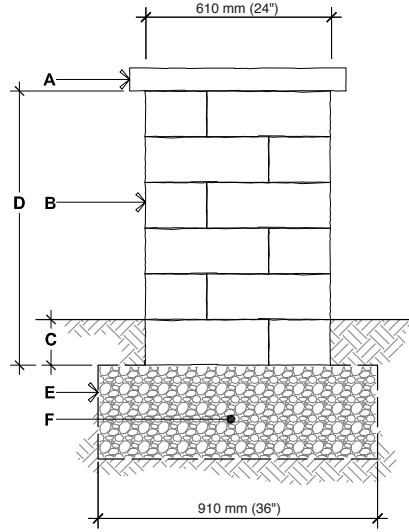
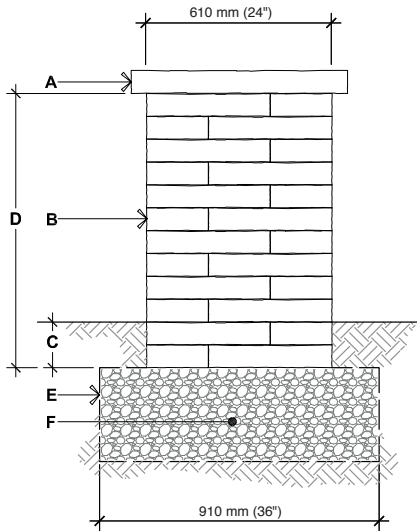

### PILLAR 24"x3"

#### MINI-CRETA

- A. PILLAR CAP UNIT  
(SECURE WITH CONCRETE ADHESIVE)
- B. PILLAR 24" x 3" (MINI-CRETA) UNIT  
SECURE EACH ROW WITH CONCRETE  
ADHESIVE
- C. EMBEDMENT 6" (150 mm) MIN.
- D. 35 7/16" (900 mm), HEIGHT PER PALLET  
47 1/4" (1200 mm), MAXIMUM HEIGHT
- E. GEOTEXTILE
- F. COMPACTED GRANULAR BASE 150 mm  
(6") THICK MIN. THICKNESS ACCORDING  
TO PROJECT SPECIFIC CONDITIONS

### PILLAR 24"x6"

#### MINI-CRETA

- A. PILLAR CAP UNIT  
(SECURE WITH CONCRETE ADHESIVE)
- B. PILLAR 24" x 6" (MINI-CRETA) UNIT  
SECURE EACH ROW WITH CONCRETE  
ADHESIVE
- C. EMBEDMENT 6" (150 mm) MIN.
- D. 35 7/16" (900 mm), HEIGHT PER PALLET  
47 1/4" (1200 mm), MAXIMUM HEIGHT
- E. GEOTEXTILE
- F. COMPACTED GRANULAR BASE 150 mm (6")  
THICK MIN. THICKNESS ACCORDING TO  
PROJECT SPECIFIC CONDITIONS

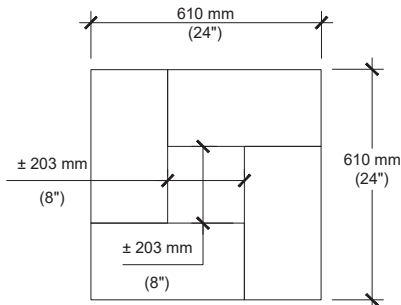

For all possible combinations of pillars and caps, please refer to the correspondence table on page 145

# INSTALLATION GUIDE

## GRILL ISLAND 6 FT - MINI-CRETA 3" AND 6"

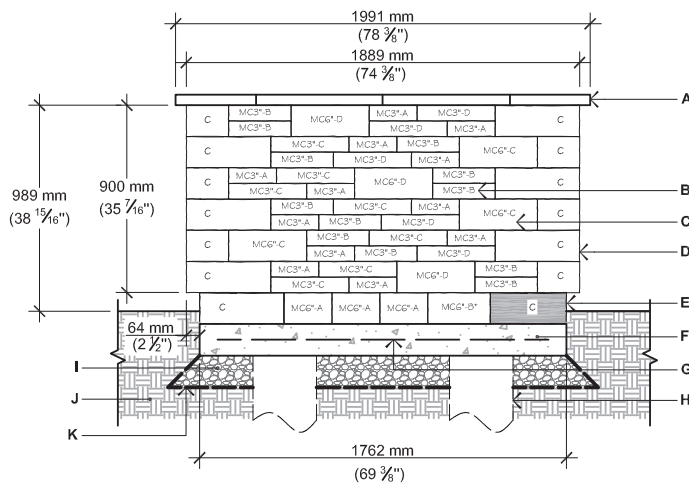
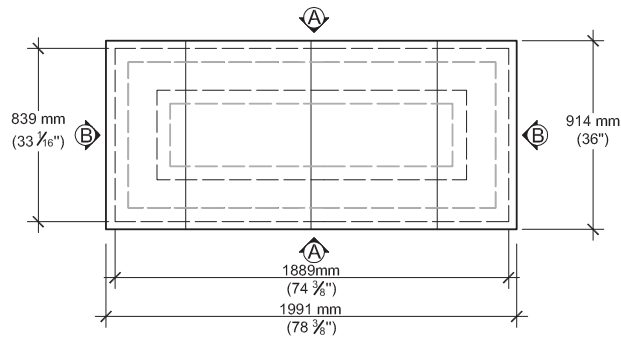

ELEVATION A

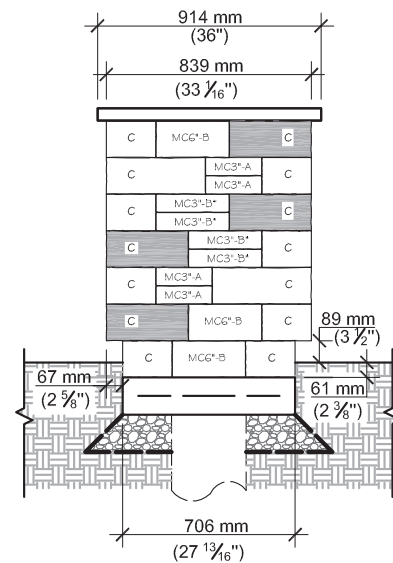

ELEVATION B

- A. YORK COUNTER TOP 24" × 36" × 2 1/4"
- B. MINI-CRETA 3" UNIT (A, B, B\*, C, OR D)
- C. MINI-CRETA 6" UNIT (A, B, B\*, C, OR D)
- D. PILLAR 24" × 36" (MINI-CRETA) UNIT
- E. PILLAR 24" × 36" (MINI-CRETA) UNIT (CUT ON FIELD)
- F. CAST IN PLACE CONCRETE SLAB 4350 psi (30 MPa), 5" (125 mm) THICK
- G. 4X4-4/4 (102X102-MW25.8XMW25.8) WELDED WIRE MESH AND/OR REBAR AS PER SITE CONDITIONS
- H. 12" (300 mm) DIA. CONCRETE PILLAR, AS PER LOCAL CODE
- I. 3/4" (20 mm) CLEAN STONE 6" (150 mm) THICK MIN. AS PER SITE CONDITIONS
- J. NATURAL SOIL OR COMPACTED BACKFILL
- K. GEOTEXTILE

### QUANTITY OF MATERIALS REQUIRED

- York Counter top 24" × 36" × 2 1/4": **4**
- Mini-Creta 3" unit: **32 A, 24 B, 8 B\*, 14 C, 10 D**
- Mini-Creta 6" unit: **6 A, 6 B, 2 B\*, 6 C, 6 D**
- Pillar 24" × 6" (Mini-Creta) unit: **28**

**NOTE:** Appliances and utilities may vary for each project and are not shown on this drawing. This drawing is shown for inspiration only and surplus or shortage of materials may result. It is the user's responsibility to verify for the quantity of materials required. Secure the blocks using a heat resistant concrete adhesive. The installer must ensure that the installation and use of the grill island comply with local regulations and code requirements. Concrete pillars extending to frost line may be required as per local code. Check your local building code before installing.

# INSTALLATION GUIDE

## SQUARE FIRE PIT - MINI-CRETA 3" AND 6"

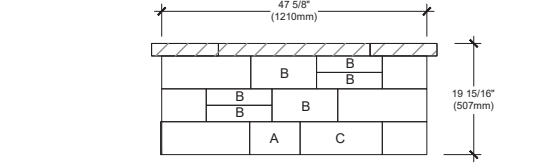
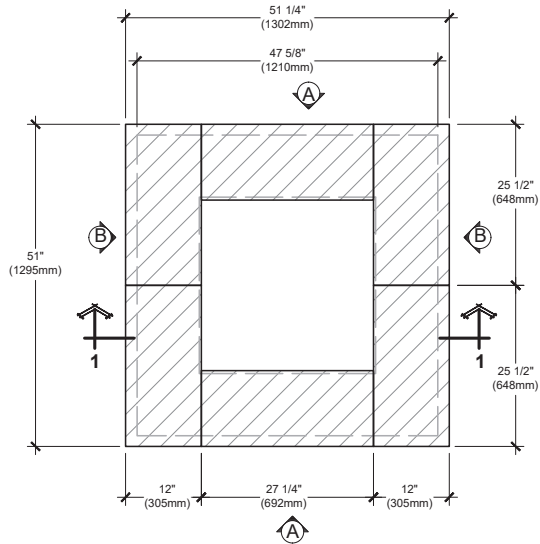

ELEVATION A

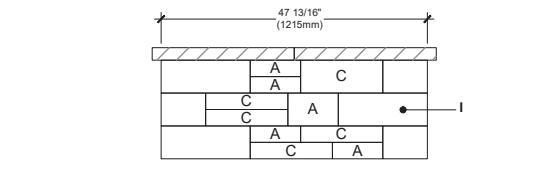

ELEVATION B

TOP

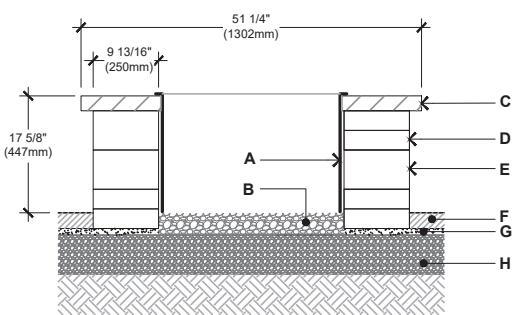

CUT ON FIELD

SECTION 1-1

- A. STEEL BOX INSERT
- B. CLEAN CTONE 3/4" (20 mm), 4" (100 mm) THICK
- C. PIEDIMONTE CAP (12"X30")
- D. MINI-CRETA 3" BLOCK
- E. MINI-CRETA 6" BLOCK
- F. TECO-BLOC PAVERS OR SLABS
- G. SETTING BED 1" (25 mm)
- H. COMPACTED GRANULAR 0-3/4" (0-20 mm)
- I. PILLAR 24"X6" MINI-CRETA

### QUANTITY OF MATERIALS REQUIRED

- Piedimonte Cap: 6
- Mini-Creta 3" **A**: 8
- Mini-Creta 3" (**B** or **B\***): 8
- Mini-Creta 3" (**C** or **D**): 8
- Mini-Creta 6" **A**: 4
- Mini-Creta 6" (**B** or **B\***): 4
- Mini-Creta 6" (**C** or **D**): 4
- Pillar 24"x6" Mini-Creta: 12

**NOTE :** Secure the blocks using a heat resistant concrete adhesive. The installer must ensure that the installation and use of the firepit comply with local regulations and code requirements.



# PRESCOTT 2.25"

**DESCRIPTION:** Wall double-sided **TEXTURE:** Chiseled Face

## Pallet Overview

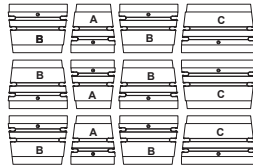

Chiseled Face  
Rock Garden Brown  
Chiseled Face  
Victoria  
Chiseled Face  
Riviera

## Specifications per pallet



	Imperial	Metric
<b>A</b> Dimension Front (L x D x H) <b>A</b>	9 x 9 13/16 x 2 1/4	229 x 250 x 57
<b>A</b> Dimension Back (L x D x H) <b>A</b>	7 7/16 x 9 13/16 x 2 1/4	189 x 250 x 57
<b>B</b> Dimension Front (L x D x H) <b>B</b>	12 x 9 13/16 x 2 1/4	305 x 250 x 57
<b>B</b> Dimension Back (L x D x H) <b>B</b>	10 7/16 x 9 13/16 x 2 1/4	265 x 250 x 57
<b>C</b> Dimension Front (L x D x H) <b>C</b>	15 x 9 13/16 x 2 1/4	381 x 250 x 57
<b>C</b> Dimension Back (L x D x H) <b>C</b>	13 7/16 x 9 13/16 x 2 1/4	341 x 250 x 57
	27 ft <sup>2</sup>	2.51 m <sup>2</sup>
Cubing	144 lin. ft	43.89 lin. m
Approx. Weight	2 661 lbs	1 207 kg
Minimum radius	5.2 ft	1.6 m
Number of rows	12	
Coverage per row	2.25 ft <sup>2</sup>	0.21 m <sup>2</sup>
Lin. coverage per row	12 lin. ft	3.66 lin. m

## NOTES

See page 6 for icons description.

### COMPATIBLE CAPS

See page 145 for product compatibility.

When building a double-sided wall one pallet will cover an average of 25.23 ft<sup>2</sup>.

\*For an authentic look, each color option is composed of a variety of darker & lighter tones. Natural ingredients such as granite are present within the recipe to allow for a range in tones, veining and textures from one stone to another.



The dimensional tolerance for Stonedge wet cast retaining wall units is: ± 3/16" (5 mm) for height and ± 1/2" (13 mm) for length and width. During the installation, the level between adjacent wall units will vary (usually more than for a dry cast wall unit) in order to obtain a more realistic appearance of a natural stone wall.

See page 146 to 161 for more technical information.



# PRESCOTT 4.5"

DESCRIPTION: Wall double-sided TEXTURE: Chiseled Face

Specifications per pallet	Imperial	Metric	
<b>A</b>  18 units / pallet	Dimension Front (L x D x H) <b>A</b>	9 x 9 13/16 x 4 1/2	229 x 250 x 114
	Dimension Back (L x D x H) <b>A</b>	7 7/16 x 9 13/16 x 4 1/2	189 x 250 x 114
<b>B</b>  36 units / pallet	Dimension Front (L x D x H) <b>B</b>	12 x 9 13/16 x 4 1/2	305 x 250 x 114
	Dimension Back (L x D x H) <b>B</b>	10 7/16 x 9 13/16 x 4 1/2	265 x 250 x 114
<b>C</b>  18 units / pallet	Dimension Front (L x D x H) <b>C</b>	15 x 9 13/16 x 4 1/2	381 x 250 x 114
	Dimension Back (L x D x H) <b>C</b>	13 7/16 x 9 13/16 x 4 1/2	341 x 250 x 114
Cubing	27 ft <sup>2</sup>	2.51 m <sup>2</sup>	
	72 lin. ft	21.95 lin. m	
Approx. Weight	2 728 lbs	1 237 kg	
Minimum radius	5.2 ft	1.6 m	
Number of rows	6		
Coverage per row	4.50 ft <sup>2</sup>	0.42 m <sup>2</sup>	
Lin. coverage per row	12 lin. ft	3.66 lin. m	

## Pallet Overview

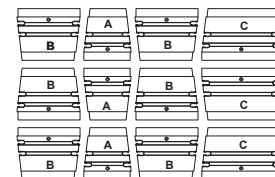

Rock Garden Brown

Chiseled Face

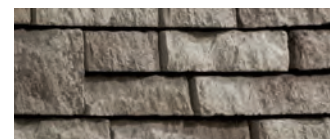

Victoria

Chiseled Face

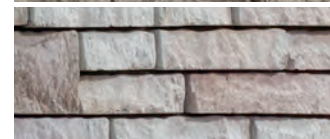

Riviera

Chiseled Face



## NOTES

See page 6 for icons description.

### COMPATIBLE CAPS

See page 145 for product compatibility.

When building a double-sided wall one pallet will cover an average of 25.23 ft<sup>2</sup>.

\*For an authentic look, each color option is composed of a variety of darker & lighter tones. Natural ingredients such as granite are present within the recipe to allow for a range in tones, veining and textures from one stone to another.

The dimensional tolerance for Stonedge wet cast retaining wall units is: ± 3/16" (5 mm) for height and ± 1/2" (13 mm) for length and width. During the installation, the level between adjacent wall units will vary (usually more than for a dry cast wall unit) in order to obtain a more realistic appearance of a natural stone wall.

See page 146 to 161 for more technical information.



# PRESCOTT

**DESCRIPTION:** Corners and pillars **TEXTURE:** Chiseled Face

## Pallet Overview

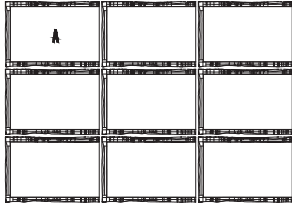

Chiseled Face  
Rock Garden Brown  
Chiseled Face  
Victoria  
Chiseled Face  
Riviera

### 2.25"

#### Specifications per pallet

	Imperial	Metric
Product dimension (L x D x H)	14 3/16 x 9 13/16 x 2 1/4	360 x 250 x 57
 Cubing	72 units	72 units
Approx. Weight	1 789 lbs	811 kg
72 units / pallet	Number of rows	8
Pillar height	40 1/2 in	1 029 mm

### 4.5"

#### Specifications per pallet

	Imperial	Metric
Product dimension (L x D x H)	14 3/16 x 9 13/16 x 4 1/2	360 x 250 x 114
 Cubing	36 units	36 units
Approx. Weight	1 871 lbs	849 kg
36 units / pallet	Number of rows	4
Pillar height	40 1/2 in	1 029 mm

## NOTES

See page 6 for icons description.

### COMPATIBLE CAPS

See page 145 for product compatibility.

\*For an authentic look, each color option is composed of a variety of darker & lighter tones. Natural ingredients such as granite are present within the recipe to allow for a range in tones, veining and textures from one stone to another.

The dimensional tolerance for Stonedge wet cast retaining wall units is: ± 3/16" (5 mm) for height and ± 1/2" (13 mm) for length and width. During the installation, the level between adjacent wall units will vary (usually more than for a dry cast wall unit) in order to obtain a more realistic appearance of a natural stone wall.

See page 146 to 161 for more technical information.

## RETAINING WALLS - PRESCOTT

The different modules of the Prescott retaining wall allow the installation of different block combinations.

Eight combinations are shown as an example. Each combination is 24" (610 mm) long and 6 3/4" (171 mm) high.

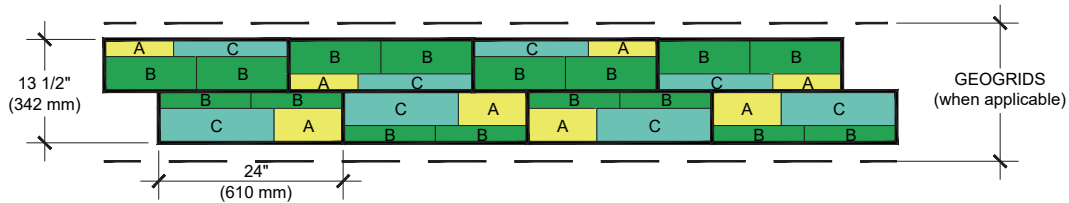
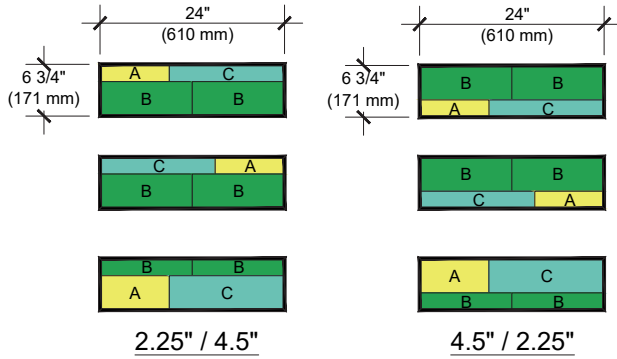

NUMBER OF BLOCKS REQUIRED

MODULE

PRESCOTT

	A	B	C
33% of the surface - Prescott 2.25"	4	8	8
67% of the surface - Prescott 4.5"	2	8	2

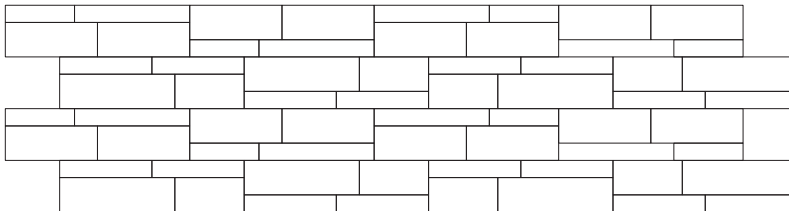

# INSTALLATION GUIDE

## FREESTANDING WALLS - PRESCOTT 2.25" & 4.5"

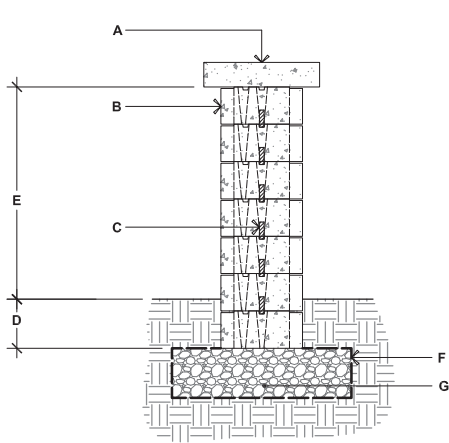

### PRESCOTT 2.25" & 4.5"

- A. TECO-BLOC CAP UNIT, SECURED TO UNIT BELOW WITH CONCRETE ADHESIVE
- B. PRESCOTT 2.25" AND 4.5" DOUBLE-SIDED WALL UNITS SECURE EACH ROW WITH CONCRETE ADHESIVE
- C. CONNECTOR
- D. EMBEDMENT DEPTH, 6" (150 mm) MIN.
- E. 25 1/2" (650 mm) MAX.
- F. GEOTEXTILE
- G. COMPACTED GRANULAR LEVELING PAD, 6" (150 mm) THICK MIN. THICKNESS ACCORDING TO PROJECT SPECIFIC CONDITIONS

## 90° CORNER OF A DOUBLE-SIDED WALL

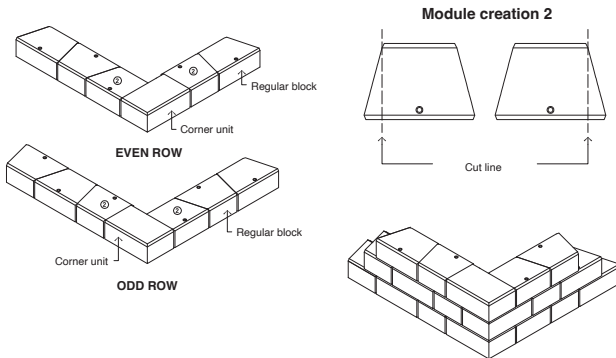

## DOUBLE-SIDED WALL - END OF A STRAIGHT WALL

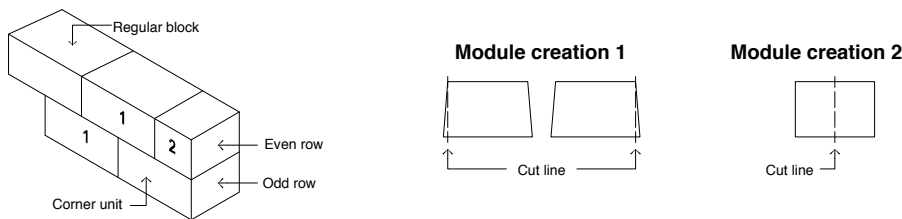

### GENERAL NOTES

1. Alternate odd and even rows.
2. Stagger joints from one row to the next.
3. Glue all modules at each row with concrete adhesive.
4. Cavities, grooves and connectors are not illustrated to avoid overloading the image.

# INSTALLATION GUIDE

## DOUBLE-SIDED WALL RADIUS - PRESCOTT 2.25" & 4.5"

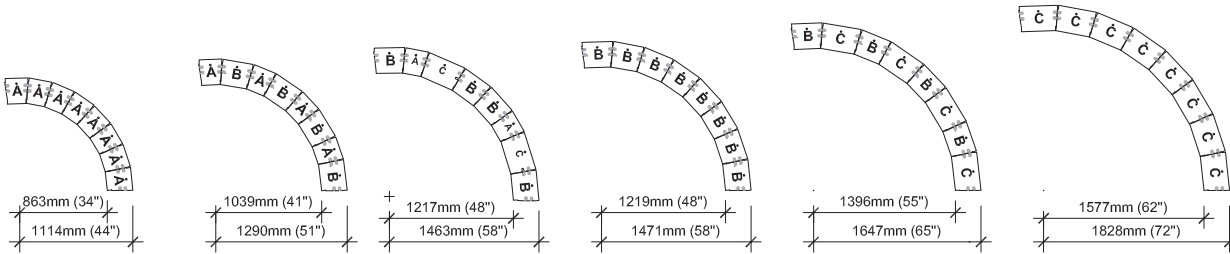

It is the user's responsibility to verify for the quantity of materials required.

## STEPS

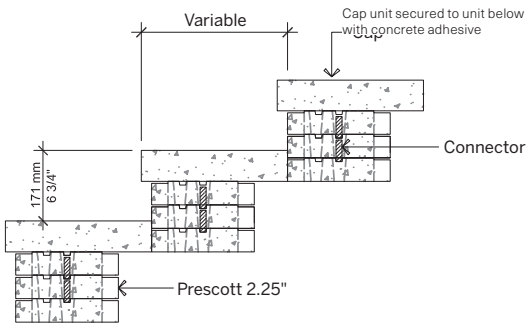

For all possible combinations of pillars and caps, please refer to the correspondence table on page 145

Check with your local Building Codes to determine any restrictions or guidelines regarding the dimensions of steps (including riser height and step tread) as well as handrail specifications.

# INSTALLATION GUIDE

## PILLARS - PRESCOTT 2.25" & 4.5"

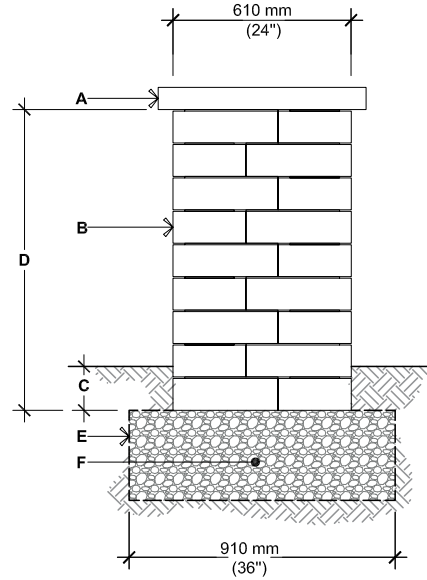
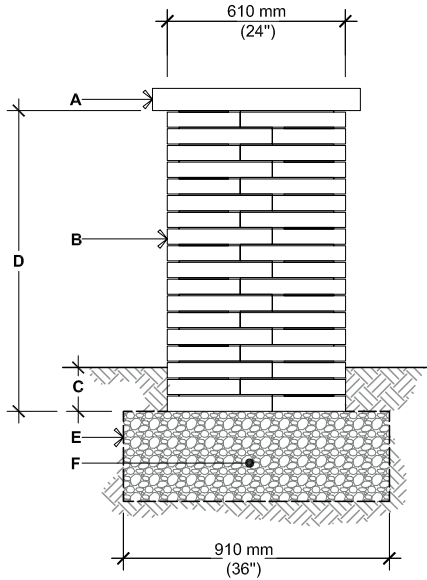

### PRESCOTT 2.25"

- A. PILLAR CAP UNIT  
(SECURE WITH CONCRETE ADHESIVE)
- B. PRESCOTT 2.25" PILLAR UNIT SECURE EACH ROW WITH CONCRETE ADHESIVE
- C. EMBEDMENT DEPTH, 6" (150 mm) MIN.
- D. 40 ½" (1 029 mm), HEIGHT PER PALLET  
45" (1 143 mm), MAX. HEIGHT
- E. GEOTEXTILE
- F. COMPACTED GRANULAR BASE 6" (150 mm)  
THICK MIN. THICKNESS ACCORDING TO  
PROJECT SPECIFIC CONDITIONS

### PRESCOTT 4.5"

- A. PILLAR CAP UNIT  
(SECURE WITH CONCRETE ADHESIVE)
- B. PRESCOTT 4.5" PILLAR UNIT SECURE EACH ROW  
WITH CONCRETE ADHESIVE
- C. EMBEDMENT DEPTH, 6" (150 mm) MIN.
- D. 40 ½" (1 029 mm), HEIGHT PER PALLET  
45" (1 143 mm), MAX. HEIGHT
- E. GEOTEXTILE
- F. COMPACTED GRANULAR BASE  
6" (150 mm) THICK MIN. THICKNESS ACCORDING  
TO PROJECT SPECIFIC CONDITIONS

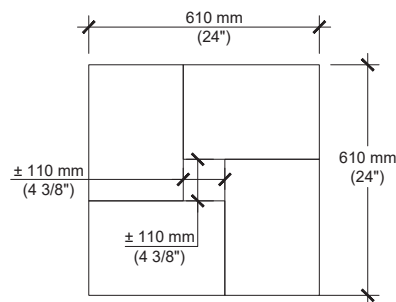

For all possible combinations of pillars and caps, please refer to the correspondence table on page 145

# INSTALLATION GUIDE

## PILLARS - PRESCOTT 2.25" & 4.5"

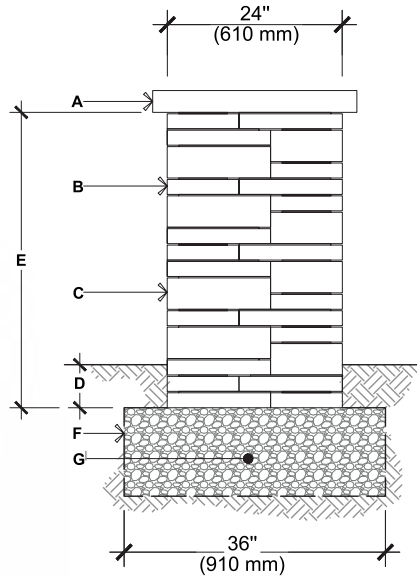
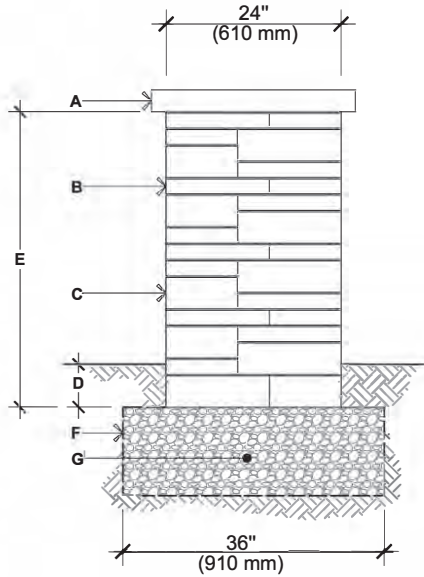

### PRESCOTT 2.25" & 4.5" OPTION A

- A. PILLAR CAP UNIT (SECURE WITH CONCRETE ADHESIVE)
- B. PRESCOTT 2.25" PILLAR UNIT SECURE EACH ROW WITH CONCRETE ADHESIVE
- C. PRESCOTT 4.5" PILLAR UNIT SECURE EACH ROW WITH CONCRETE ADHESIVE
- D. EMBEDMENT DEPTH, 6" (150 mm) MIN.
- E. 40 1/2" (1 029 mm)  
45" (1 143 mm), MAX. HEIGHT
- F. GEOTEXTILE
- G. COMPACTED GRANULAR BASE 6" (150 mm) THICK MIN. THICKNESS ACCORDING TO PROJECT SPECIFIC CONDITIONS

### PRESCOTT 2.25" & 4.5" OPTION B

- A. PILLAR CAP UNIT (SECURE WITH CONCRETE ADHESIVE)
- B. PRESCOTT 2.25" PILLAR UNIT SECURE EACH ROW WITH CONCRETE ADHESIVE
- C. PRESCOTT 4.5" PILLAR UNIT SECURE EACH ROW WITH CONCRETE ADHESIVE
- D. EMBEDMENT DEPTH, 6" (150 mm) MIN.
- E. 40 1/2" (1 029 mm)  
45" (1 143 mm), MAX. HEIGHT
- F. GEOTEXTILE
- G. COMPACTED GRANULAR BASE 6" (150 mm) THICK MIN. THICKNESS ACCORDING TO PROJECT SPECIFIC CONDITIONS

**NOTE:** Two pillars of 40 1/2" total height (one option A and one option B) required one pallet of Prescott 4.5" Pillar unit and one pallet of Prescott 2.25" Pillar unit.

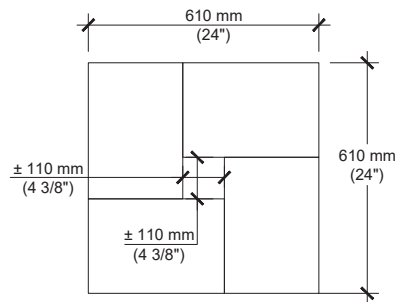

For all possible combinations of pillars and caps, please refer to the correspondence table on page 145

D ❄️

## RAFFINATO 90 & 180 mm

DESCRIPTION: Wall TEXTURE: Polished (on a single-side only)

### Pallet Overview - 90 mm

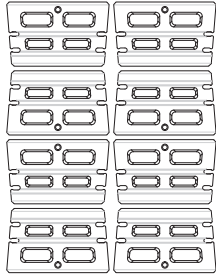

### Pallet Overview - 180 mm

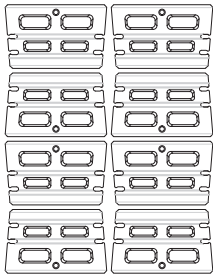

Polished  
Beige Cream

Polished  
Greyed Nickel

Polished  
Onyx Black

### 90 mm

#### Specifications per pallet

	Imperial	Metric
Dimension Front (L x D x H)	15 5/8 x 9 5/8 x 3 3/16	397 x 245 x 90
Dimension Back (L x D x H)	14 1/4 x 9 5/8 x 3 3/16	362 x 245 x 90
Cubing	23.08 ft <sup>2</sup>	2.14 m <sup>2</sup>
60 units / pallet	78.15 lin ft	23.82 lin m
Approx. Weight	1 948 lbs	884 kg
Minimum radius	8.5 ft	2.6 m
Number of rows	3	
Coverage per row	7.69 ft <sup>2</sup>	0.71 m <sup>2</sup>
Linear coverage per row	26.05 lin ft	7.94 lin m



60 units / pallet

### 180 mm

#### Specifications per pallet

	Imperial	Metric
Dimension Front (L x D x H)	15 5/8 x 9 5/8 x 7 1/16	397 x 245 x 180
Dimension Back (L x D x H)	14 1/4 x 9 5/8 x 7 1/16	362 x 245 x 180
Cubing	23.08 ft <sup>2</sup>	2.14 m <sup>2</sup>
30 units / pallet	39.07 lin ft	11.91 lin m
Approx. Weight	1 936 lbs	878 kg
Minimum radius	8.5 ft	2.6 m
Number of rows	3	
Coverage per row	7.69 ft <sup>2</sup>	0.71 m <sup>2</sup>
Linear coverage per row	13.02 lin ft	3.97 lin m



30 units / pallet

### NOTES

See page 6 for icons description.

#### COMPATIBLE CAPS

See page 145 for product compatibility.

Polished only on one side, Smooth on the other side.

See page 146 to 161 for more technical information.

**Polished is made-to-order, minimum order of 500 sq. ft. Deposit required.**



## RAFFINATO 90 & 180 mm

DESCRIPTION: Wall double-sided TEXTURE: Smooth

### 90 mm

#### Specifications per pallet



64 units / pallet

	Imperial	Metric
Dimension Front (L x D x H)	15 5/8 x 9 13/16 x 3 9/16	397 x 249 x 90
Dimension Back (L x D x H)	14 1/4 x 9 13/16 x 3 9/16	362 x 249 x 90
Cubing	24.61 ft <sup>2</sup>	2.29 m <sup>2</sup>
Approx. Weight	2 060 lbs	934 kg
Minimum radius	8.5 ft	2.6 m
Number of rows	8	
Coverage per row	3.08 ft <sup>2</sup>	0.29 m <sup>2</sup>
Linear coverage per row	10.42 lin. ft	3.18 lin. m

### 180 mm

#### Specifications per pallet



32 units / pallet

	Imperial	Metric
Dimension Front (L x D x H)	15 5/8 x 9 13/16 x 7 1/16	397 x 249 x 180
Dimension Back (L x D x H)	14 1/4 x 9 13/16 x 7 1/16	362 x 249 x 180
Cubing	24.61 ft <sup>2</sup>	2.29 m <sup>2</sup>
Approx. Weight	2 071 lbs	939 kg
Minimum radius	8.5 ft	2.6 m
Number of rows	4	
Coverage per row	6.15 ft <sup>2</sup>	0.57 m <sup>2</sup>
Linear coverage per row	10.42 lin. ft	3.18 lin. m

### Pallet Overview - 90 mm & 180 mm

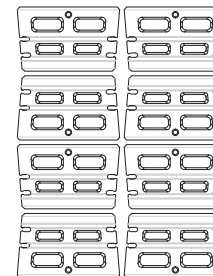

Caffè Crema

Smooth



Beige Cream

Smooth

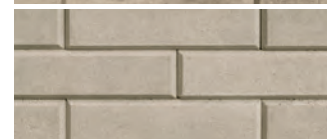

Greyed Nickel

Smooth



Shale Grey

Smooth



Onyx Black

Smooth



## NOTES

See page 6 for icons description.

### COMPATIBLE CAPS

See page 145 for product compatibility.

When building a double-sided wall one pallet will cover an average of 23.53 ft<sup>2</sup>.

See page 146 to 161 for more technical information.

D ❄️

# RAFFINATO 90 & 180 mm

**DESCRIPTION:** Pillars, corners and edges **TEXTURE:** Polished (on a single-side only)

### Pallet Overview - 90 mm

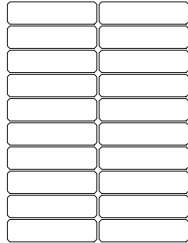

### Pallet Overview - 180 mm

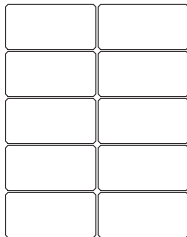

### 90 mm

#### Specifications per pallet



40 units / pallet

	Imperial	Metric
Product dimension (L x D x H)	14 1/8 x 9 5/8 x 3 5/8	357 x 245 x 90
Cubing	40 units	40 units
Approx. Weight	1 559 lbs	707 kg
Number of rows	2	
Pillar height	35 7/8 in	900 mm

### 180 mm

#### Specifications per pallet



20 units / pallet

	Imperial	Metric
Product dimension (L x D x H)	14 1/8 x 9 5/8 x 7 1/8	357 x 245 x 180
Cubing	20 units	20 units
Approx. Weight	1 557 lbs	706 kg
Number of rows	2	
Pillar height	35 7/8 in	900 mm



Polished  
Beige Cream

Polished  
Greyed Nickel

Polished  
Onyx Black

## NOTES

See page 6 for icons description.

### COMPATIBLE CAPS

See page 145 for product compatibility.

Polished only on one side, Smooth on the other side.

See page 146 to 161 for more technical information.

**Polished is made-to-order, minimum order of 500 sq. ft. Deposit required.**



D ❄️

## RAFFINATO 90 & 180 mm

DESCRIPTION: Pillars, corners and edges TEXTURE: Smooth

### 90 mm

Specifications per pallet		Imperial	Metric
	Product dimension (L x D x H)	14 1/8 x 9 13/16 x 3 9/16	359 x 249 x 90
	Cubing	48 units	48 units
	Approx. Weight	1 548 lbs	702 kg
	Number of rows	2	
	Pillar height	42 1/2 in	1 080 mm

48 units / pallet

### 180 mm

Specifications per pallet		Imperial	Metric
	Product dimension (L x D x H)	14 1/8 x 9 13/16 x 7 1/16	359 x 249 x 180
	Cubing	24 units	24 units
	Approx. Weight	1 529 lbs	694 kg
	Number of rows	2	
	Pillar height	42 1/2 in	1 080 mm

24 units / pallet

### Pallet Overview - 90 mm

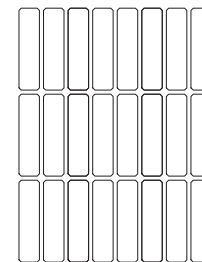

### Pallet Overview - 180 mm

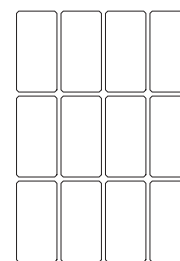

## NOTES

See page 6 for icons description.

### COMPATIBLE CAPS

See page 145 for product compatibility.

See page 146 to 161 for more technical information.

Caffé Crema

Smooth



Beige Cream

Smooth



Greyed Nickel

Smooth



Shale Grey

Smooth



Onyx Black

Smooth



# TECHO—BLOC

## DESIGN CHART RAFFINATO 180 mm

(EQUIVALENT TO TWICE THE RAFFINATO 90 mm)  
SETBACK POSITION

CLEAN SAND/GRAVEL/ SAND AND GRAVEL MIXES ( $\phi=34^\circ$ ,  $\gamma = 120$  pcf)  
GEOGRID: MIRAGRID 3XT BY TENCATE (RFd=1.10, RFcr=1.45, RFid=1.25, Cds=0.9, Ci=0.9)

**CASE N° 1 :**  
No Surcharge  
No Backslope  
No Toe Slope

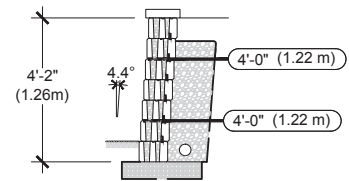
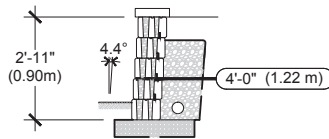
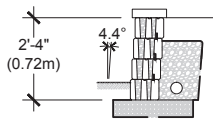

VISIT [WWW.TECHO-BLOC.COM](http://WWW.TECHO-BLOC.COM) FOR COMPLETE DESIGN CHART DOCUMENT  
(USA AND CANADA VERSIONS)

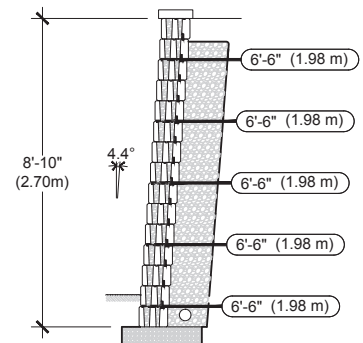
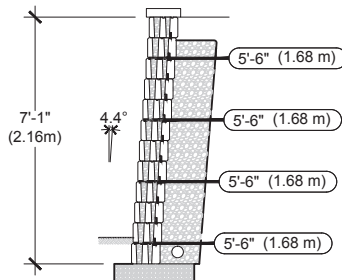
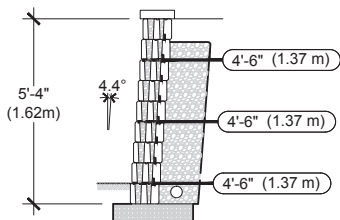

1. The information contained in the design charts is supplied for information purposes only and as such should only be used for preliminary designs.
2. The height (H) of the wall is the total height from the leveling pad to the top of the wall not including the thickness of the cap.
3. Soil parameters: reinforced soil ( $\phi = 34^\circ$ ,  $\gamma = 120$  pcf); retained soil ( $\phi = 34^\circ$ ,  $\gamma = 120$  pcf); foundation soil ( $\phi = 34^\circ$ ,  $\gamma = 120$  pcf)
4. A qualified engineer should be consulted for the final design to be used for construction.
5. The foundation soil must be able to support the wall system. The bearing capacity of the foundation soil, settlement, and global stability must be verified and validated by a qualified geotechnical engineer.
6. The seismic analysis is not included.
7. The design charts do not apply to tiered walls.
8. The charts assume that the walls are constructed in accordance with Tehco-Bloc specifications, good construction practice and an adequate drainage system.
9. The geogrid layout has been optimized to satisfy the design requirements of the NCMA's Design Manual for Segmental Retaining Walls, 3rd Edition.
10. The minimum burial depth must be 6 in (150 mm) or 10% of the exposed height, whichever is greater.
11. Engineering judgement should be used when interpolating between heights.
12. Tehco-Bloc and its predecessors, successors, beneficiaries, employees, associates, administrators and insurers accepts no liability for the incorrect use of information contained in the design charts.
13. For further information, please contact our technical service department.

# INSTALLATION GUIDE

## RETAINING WALLS - RAFFINATO 90 mm & 180 mm

The different modules of the Raffinato retaining wall allow the installation of different block combinations.

Two combinations are shown as an example. Combinations are 15 5/8" (398 mm) long and 10 5/8" (270 mm) high.

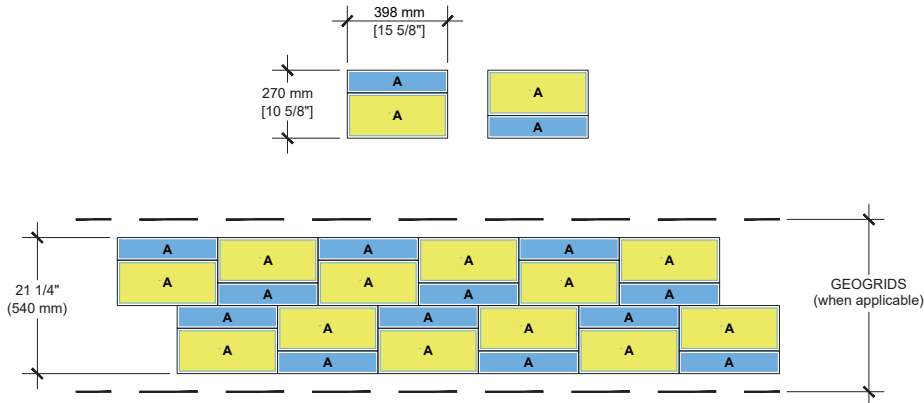

NUMBER OF BLOCKS REQUIRED	MODULE
<b>RAFFINATO</b>	<b>A</b>
<b>67 % of the surface</b> - Raffinato 90 mm	2
<b>33 % of the surface</b> - Raffinato 180 mm	2

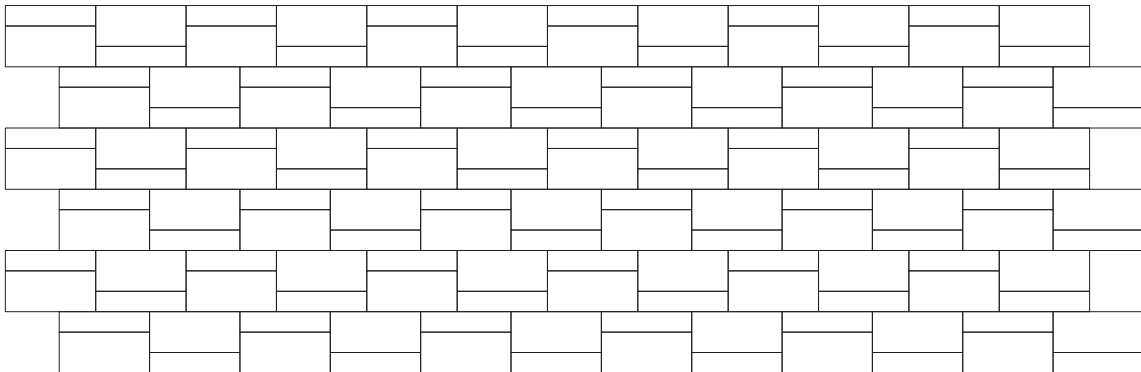

# INSTALLATION GUIDE

## FREESTANDING WALLS - RAFFINATO 90 MM & 180 MM

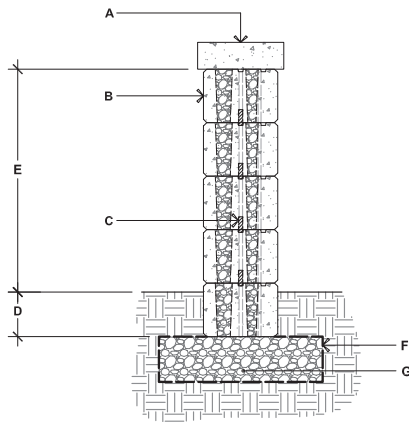

### RAFFINATO 90 mm & 180 mm

- A.** TECO-BLOC CAP UNIT SECURED TO UNIT BELOW WITH CONCRETE ADHESIVE
- B.** RAFFINATO 90 mm AND 180 mm DOUBLE-SIDED WALL UNITS SECURE EACH ROW WITH CONCRETE ADHESIVE
- C.** CONNECTOR
- D.** EMBEDMENT DEPTH, 6" (150 mm) MIN.
- E.** 29 7/16" (750 mm) MAX.
- F.** GEOTEXTILE
- G.** COMPACTED GRANULAR LEVELING PAD, 6" (150 mm) THICK MIN. THICKNESS ACCORDING TO PROJECT SPECIFIC CONDITIONS

## 90° CORNER OF A DOUBLE-SIDED WALL

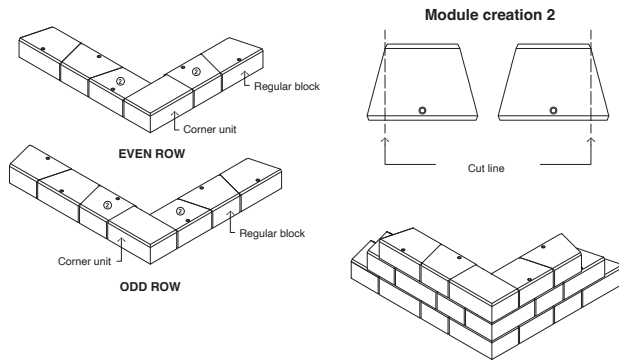

## DOUBLE-SIDED WALL RADIUS

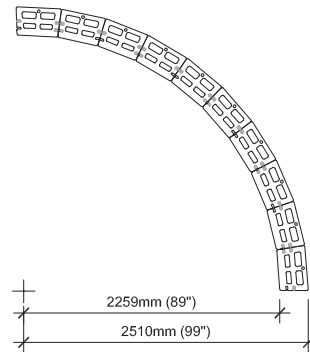

It is the user's responsibility to verify for the quantity of materials required.

## DOUBLE SIDED WALL - END OF A STRAIGHT WALL

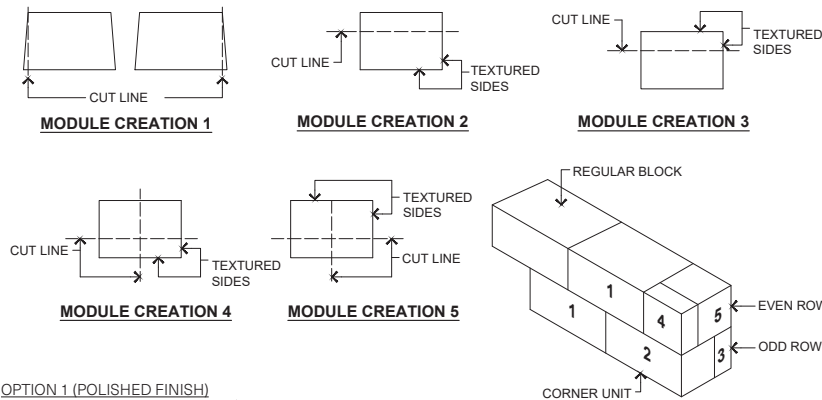

### GENERAL NOTES

- 1.** Alternate odd and even rows.
- 2.** Stagger joints from one row to the next.
- 3.** Glue all modules at each row with concrete adhesive.
- 4.** Cavities, grooves and connectors are not illustrated to avoid overloading the image.

OPTION 1 (POLISHED FINISH)

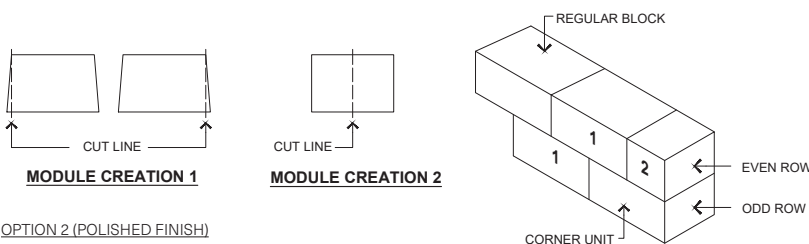

OPTION 2 (POLISHED FINISH)

PLEASE REFER TO P.4 FOR THE CORRECT USE AND LIMITATIONS OF PROVIDED TECHNICAL INFORMATION.

# INSTALLATION GUIDE

## PILLARS - RAFFINATO 90 mm & 180 mm

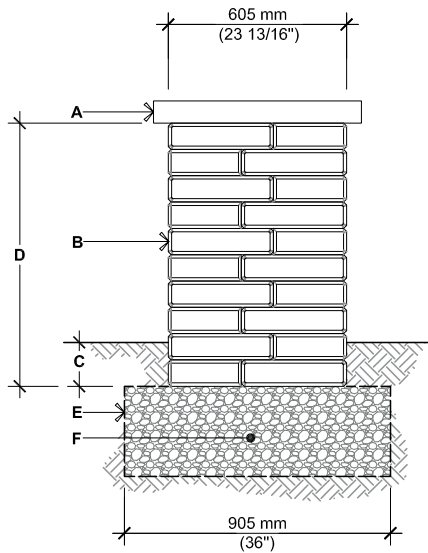

### RAFFINATO 90 mm

- A.** STONEDGE COLLECTION PILLAR CAP UNIT, SECURE TO UNITS BELOW WITH CONCRETE ADHESIVE
- B.** RAFFINATO 90 mm PILLAR UNIT SECURE EACH ROW WITH CONCRETE ADHESIVE
- C.** EMBEDMENT DEPTH: 150 mm (6") MIN.
- D.** 1 080 mm (42 ½"), MAXIMUM HEIGHT
- E.** GEOTEXTILE
- F.** COMPACTED GRANULAR BASE 150 mm (6") THICK MIN. THICKNESS ACCORDING TO PROJECT SPECIFIC CONDITIONS

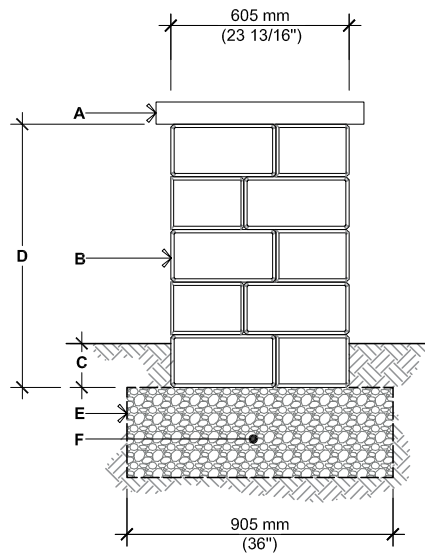

### RAFFINATO 180 mm

- A.** STONEDGE COLLECTION PILLAR CAP UNIT, SECURE TO UNITS BELOW WITH CONCRETE ADHESIVE
- B.** RAFFINATO 180 mm PILLAR UNIT SECURE EACH ROW WITH CONCRETE ADHESIVE
- C.** EMBEDMENT DEPTH: 150 mm (6") MIN.
- D.** 1080 mm (42 ½"), MAXIMUM HEIGHT
- E.** GEOTEXTILE
- F.** COMPACTED GRANULAR BASE 150 mm (6") THICK MIN. THICKNESS ACCORDING TO PROJECT SPECIFIC CONDITIONS

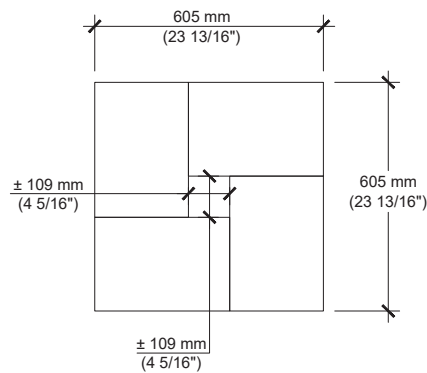

For all possible combinations of pillars and caps, please refer to the correspondence table on page 145

# INSTALLATION GUIDE

## PILLARS - RAFFINATO 90 mm & 180 mm

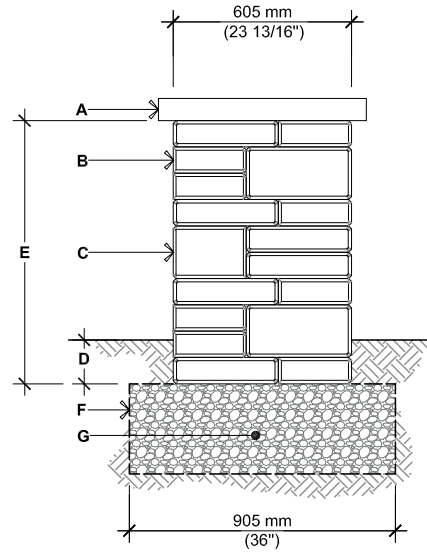
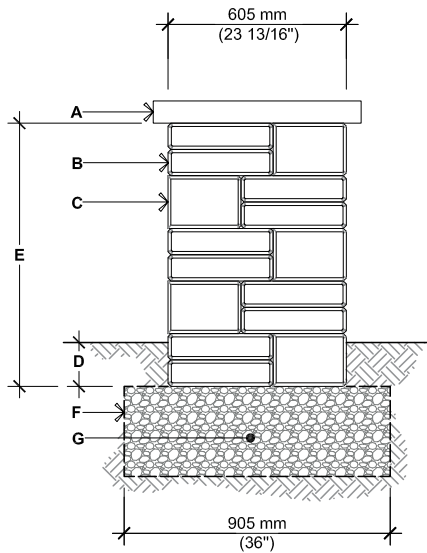

○ RAFFINATO 90 mm & 180 mm  
OPTION A

- A. STONEDGE COLLECTION PILLAR CAP UNIT, SECURE TO UNITS BELOW WITH CONCRETE ADHESIVE
- B. RAFFINATO 90 mm PILLAR UNIT SECURE EACH ROW WITH CONCRETE ADHESIVE
- C. RAFFINATO 180 mm PILLAR UNIT SECURE EACH ROW WITH CONCRETE ADHESIVE
- D. EMBEDMENT DEPTH: 150 mm (6") MIN.
- E. 1 080 mm (42 ½"), MAXIMUM HEIGHT
- F. GEOTEXTILE
- G. COMPACTED GRANULAR BASE 150 mm (6") THICK MIN. THICKNESS ACCORDING TO PROJECT SPECIFIC CONDITIONS

○ RAFFINATO 90 mm & 180 mm  
OPTION B

- A. STONEDGE COLLECTION PILLAR CAP UNIT, SECURE TO UNITS BELOW WITH CONCRETE ADHESIVE
- B. RAFFINATO 90 mm PILLAR UNIT SECURE EACH ROW WITH CONCRETE ADHESIVE
- C. RAFFINATO 180 mm PILLAR UNIT SECURE EACH ROW WITH CONCRETE ADHESIVE
- D. EMBEDMENT DEPTH: 150 mm (6") MIN.
- E. 1 080 mm (42 ½"), MAXIMUM HEIGHT
- F. GEOTEXTILE
- G. COMPACTED GRANULAR BASE 150 mm (6") THICK MIN. THICKNESS ACCORDING TO PROJECT SPECIFIC CONDITIONS

## STEPS

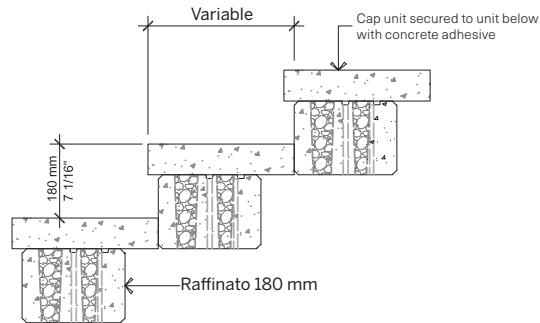
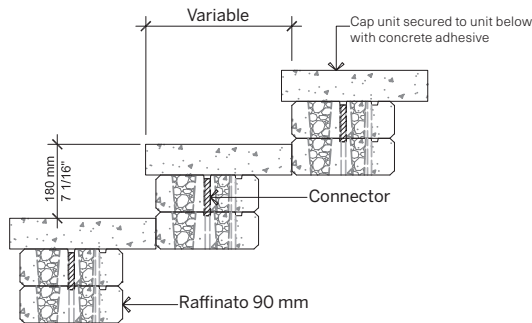

For all possible combinations of pillars and caps, please refer to the correspondence table on page 145

Check with your local Building Codes to determine any restrictions or guidelines regarding the dimensions of steps (including riser height and step tread) as well as handrail specifications.

PLEASE REFER TO P.4 FOR THE CORRECT USE AND LIMITATIONS OF PROVIDED TECHNICAL INFORMATION.

# INSTALLATION GUIDE

## GRILL ISLAND - RAFFINATO SMOOTH 90 mm & 180 mm

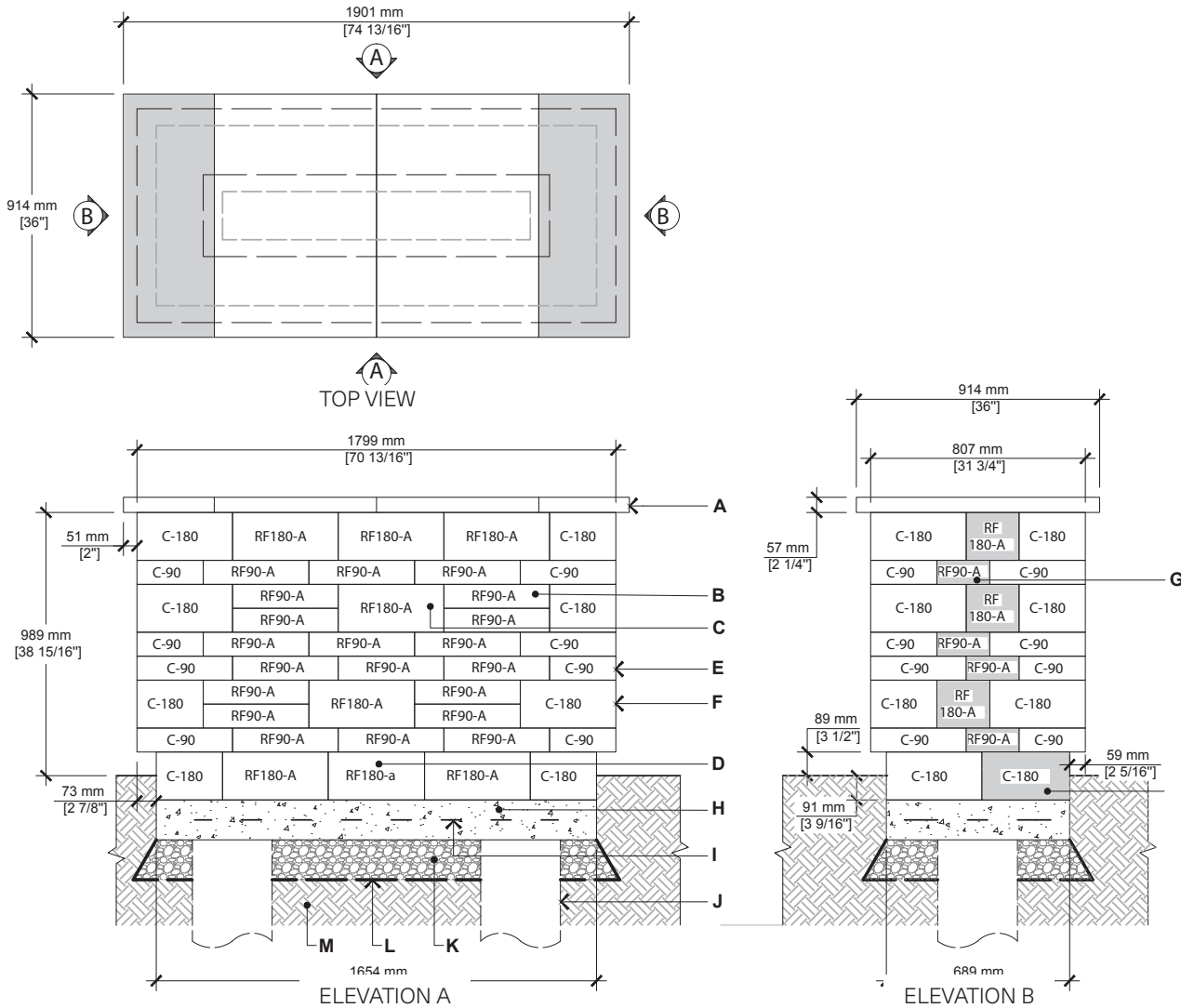

- A.** YORK COUNTER TOP 24" x 36" x 2 1/4" (CUT ON FIELD AS REQUIRED)
- B.** RAFFINATO 90 mm UNIT (A) – LONG FACE EXPOSED (SHOWN WITH UPPERCASE LETTER)
- C.** RAFFINATO 180 mm UNIT (A) – LONG FACE EXPOSED (SHOWN WITH UPPERCASE LETTER)
- D.** RAFFINATO 180 mm UNIT (A) – SHORT FACE EXPOSED (SHOWN WITH LOWERCASE LETTER)
- E.** RAFFINATO 90 mm PILLAR UNIT
- F.** RAFFINATO 180 mm PILLAR UNIT
- G.** RAFFINATO UNIT CUT ON FIELD AS REQUIRED
- H.** CAST IN PLACE CONCRETE SLAB 4350 psi (30 MPa), 5" (125 mm) THICK
- I.** 4X4-4/4 (102X102-MW25.8XMW25.8) WELDED WIRE MESH AND/OR REBAR AS PER SITE CONDITIONS
- J.** 12" (300 mm) DIA. CONCRETE PILLAR, AS PER LOCAL CODE
- K.** 3/4" (20 mm) CLEAN STONE 6" (150 mm) THICK MIN. AS PER SITE CONDITIONS
- L.** GEOTEXTILE
- M.** NATURAL SOIL OR COMPACTED BACKFILL

### QUANTITY OF MATERIALS REQUIRED

- York Counter top 24" x 36" x 2 1/4": **4**
- Raffinato 90 mm wall unit: **48 A**
- Raffinato 180 mm wall unit: **22 A**
- Raffinato 90 mm pillar unit: **16**
- Raffinato 180 mm pillar unit: **16**

**NOTE:** Appliances and utilities may vary for each project and are not shown on this drawing. This drawing is shown for inspiration only and surplus or shortage of materials may result. It is the user's responsibility to verify for the quantity of materials required. Secure the blocks using a heat resistant concrete adhesive. The installer must ensure that the installation and use of the grill island comply with local regulations and code requirements. Concrete pillars extending to frost line may be required as per local code. Check your local building code before installing.

# INSTALLATION GUIDE

## GRILL ISLAND - RAFFINATO POLISHED 90 mm & 180 mm

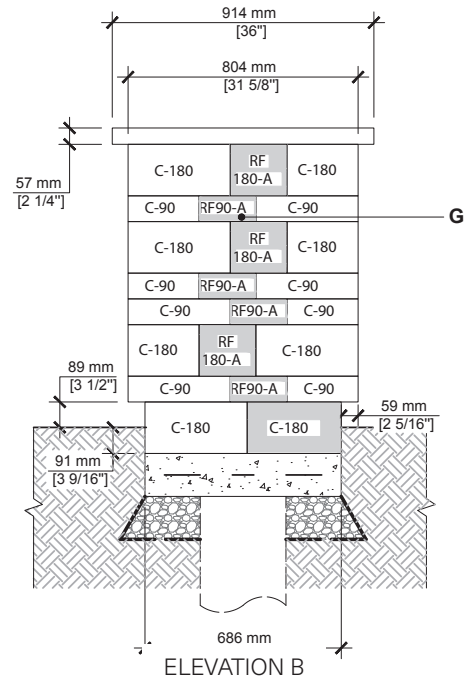
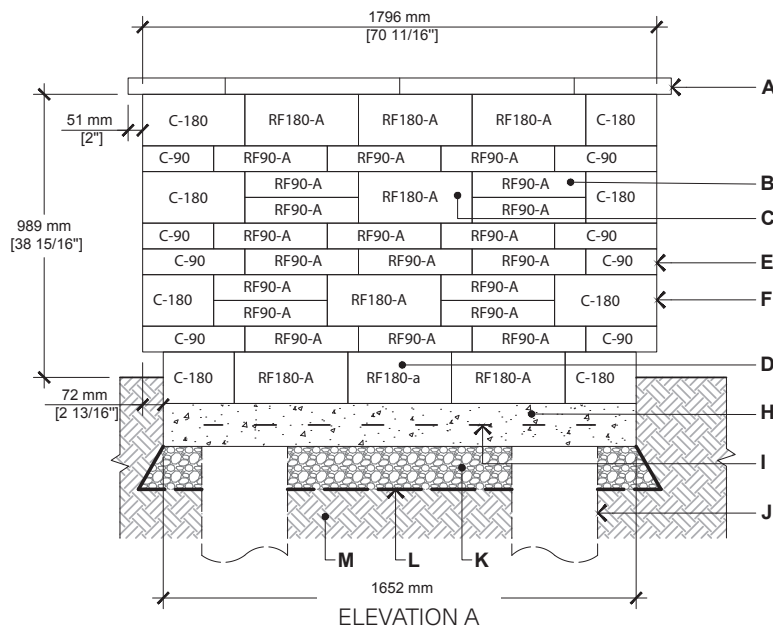
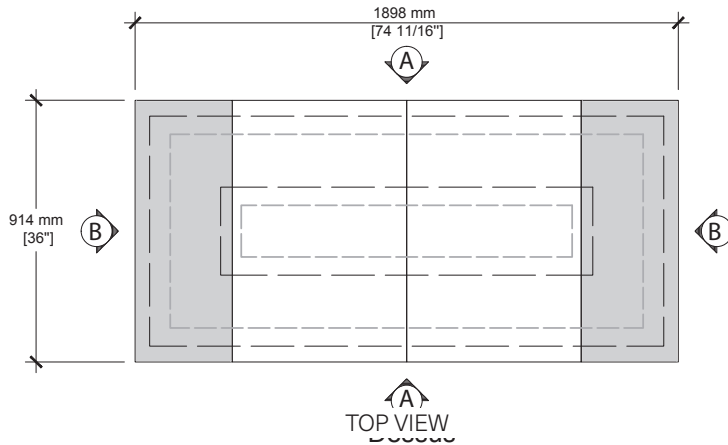

- A. YORK COUNTER TOP 24" x 36" x 2 1/4" (CUT ON FIELD AS REQUIRED)
- B. RAFFINATO 90 mm UNIT (A) – LONG FACE EXPOSED (SHOWN WITH UPPERCASE LETTER)
- C. RAFFINATO 180 mm UNIT (A) – LONG FACE EXPOSED (SHOWN WITH UPPERCASE LETTER)
- D. RAFFINATO 180 mm UNIT (A) – SHORT FACE EXPOSED (SHOWN WITH LOWERCASE LETTER)
- E. RAFFINATO 90 mm PILLAR UNIT
- F. RAFFINATO 180 mm PILLAR UNIT
- G. RAFFINATO UNIT CUT ON FIELD AS REQUIRED
- H. CAST IN PLACE CONCRETE SLAB 4350 psi (30 MPa), 5" (125 mm) THICK
- I. 4X4-4/4 (102X102-MW25.8XMW25.8) WELDED WIRE MESH AND/OR REBAR AS PER SITE CONDITIONS
- J. 12" (300 mm) DIA. CONCRETE PILLAR, AS PER LOCAL CODE
- K. 3/4" (20 mm) CLEAN STONE  
6" (150 mm) THICK MIN. AS PER SITE CONDITIONS
- L. GEOTEXTILE
- M. NATURAL SOIL OR COMPACTED BACKFILL

### QUANTITY OF MATERIALS REQUIRED



- York Counter top 24" x 36" x 2 1/4": **4**
- Raffinato 90 mm wall unit: **48 A**
- Raffinato 180 mm wall unit: **22 A**
- Raffinato 90 mm pillar unit: **16**
- Raffinato 180 mm pillar unit: **16**

**NOTE:** Appliances and utilities may vary for each project and are not shown on this drawing. This drawing is shown for inspiration only and surplus or shortage of materials may result. It is the user's responsibility to verify for the quantity of materials required. Secure the blocks using a heat resistant concrete adhesive. The installer must ensure that the installation and use of the grill island comply with local regulations and code requirements. Concrete pillars extending to frost line may be required as per local code. Check your local building code before installing.



# RÖCKA

DESCRIPTION: Wall & edge double-sided TEXTURE: Fossil stone

Specifications per pallet		Imperial	Metric
<b>A</b> 	Dimension Top (L×D×H) <b>A</b>	13 ¼ × 7 ¾ × 6	337 × 197 × 152
	Dimension Bottom (L×D×H) <b>A</b>	13 ¼ × 8 × 6	337 × 203 × 152
8 units / pallet	Dimension Top (L×D×H) <b>B</b>	26 ½ × 7 ¾ × 6	673 × 197 × 152
	Dimension Bottom (L×D×H) <b>B</b>	26 ½ × 8 × 6	673 × 203 × 152
<b>B</b> 	Dimension Top (L×D×H) <b>C</b>	39 ¾ × 7 ¾ × 6	1 010 × 197 × 152
	Dimension Bottom (L×D×H) <b>C</b>	39 ¾ × 8 × 6	1 010 × 203 × 152
8 units / pallet	Cubing	19.88 ft <sup>2</sup>	1.85 m <sup>2</sup>
	Approx. Weight	1 860 lbs	844 kg
<b>C</b> 	Number of rows	3	
	Coverage per row	6.63 ft <sup>2</sup>	0.62 m <sup>2</sup>
4 units / pallet	Coverage per unit <b>A</b>	0.55 ft <sup>2</sup>	0.05 m <sup>2</sup>
	Coverage per unit <b>B</b>	1.10 ft <sup>2</sup>	0.10 m <sup>2</sup>
	Coverage per unit <b>C</b>	1.66 ft <sup>2</sup>	0.15 m <sup>2</sup>

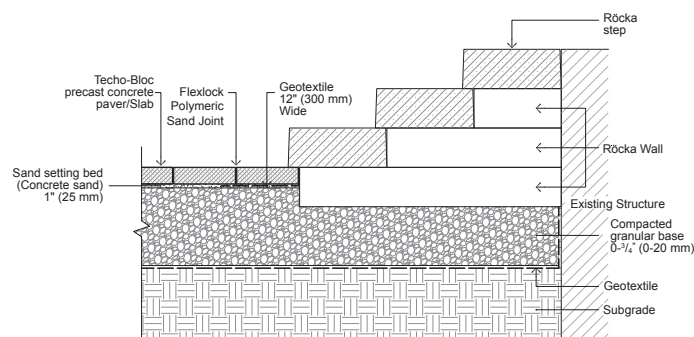

### Pallet Overview - Row 1

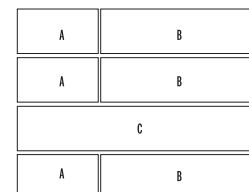

### Pallet Overview - Row 2

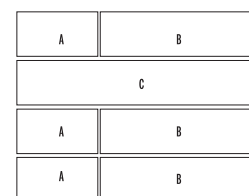

### Pallet Overview - Row 3

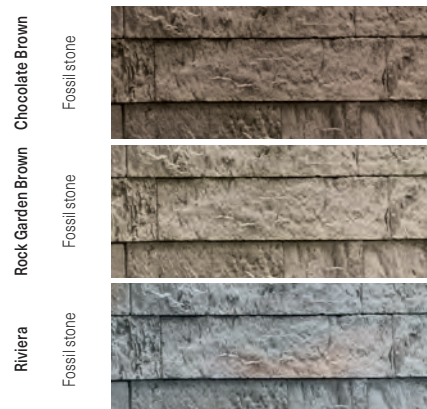
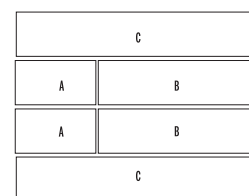

## NOTES

See page 6 for icons description.

\*For an authentic look, each color option is composed of a variety of darker & lighter tones. Natural ingredients such as granite are present within the recipe to allow for a range in tones, veining and textures from one stone to another.

See page 146 to 161 for more technical information.

The dimensional tolerance for Stonedge wet cast retaining wall units is: ± 3/16" (5 mm) for height and ± 1/2" (13 mm) for length and width. During the installation, the level between adjacent wall units will vary (usually more than for a dry cast wall unit) in order to obtain a more realistic appearance of a natural stone wall.

# INSTALLATION GUIDE

## FREESTANDING WALLS - RÖCKA

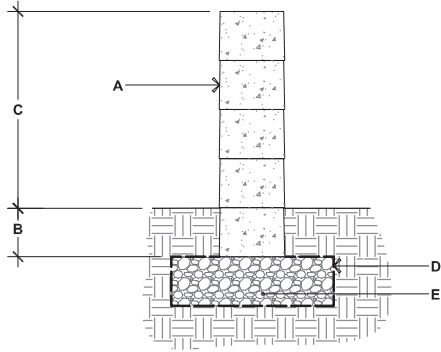

### RÖCKA

- A. RÖCKA DOUBLE-SIDED WALL UNITS SECURE EACH ROW WITH CONCRETE ADHESIVE
- B. EMBEDMENT DEPTH, 6" (150 mm) MIN.
- C. 24" (612 mm) MAX.
- D. GEOTEXTILE
- E. COMPACTED GRANULAR LEVELING PAD, 6" (150 mm) THICK MIN. THICKNESS ACCORDING TO PROJECT SPECIFIC CONDITIONS

## 90° CORNER OF A DOUBLE-SIDED WALL

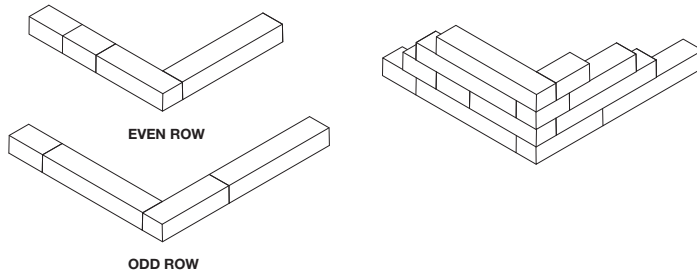

1. Alternate odd and even rows
2. Stagger vertical joints by at least  $\frac{1}{4}$  of the length of the block.
3. Glue all modules at each row with concrete adhesive.
4. It is possible to alternate the blocks (A, B or C) in the same row to create different patterns.

## DOUBLE-SIDED WALL - END OF A STRAIGHT WALL

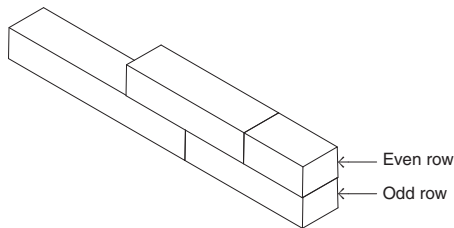

\* It is possible to alternate the blocks (A, B or C) in the same row to create different patterns. However, a minimum distance of  $\frac{1}{4}$  the length of the block is required between the vertical joints.

# INSTALLATION GUIDE

## GRILL ISLAND - RÖCKA

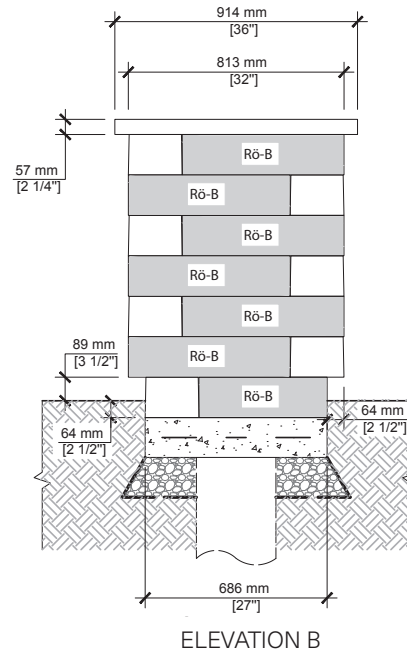
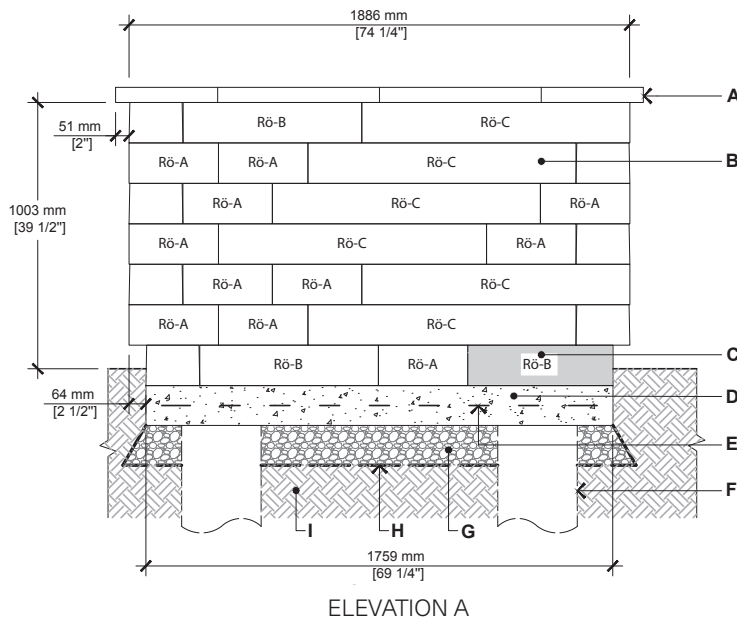
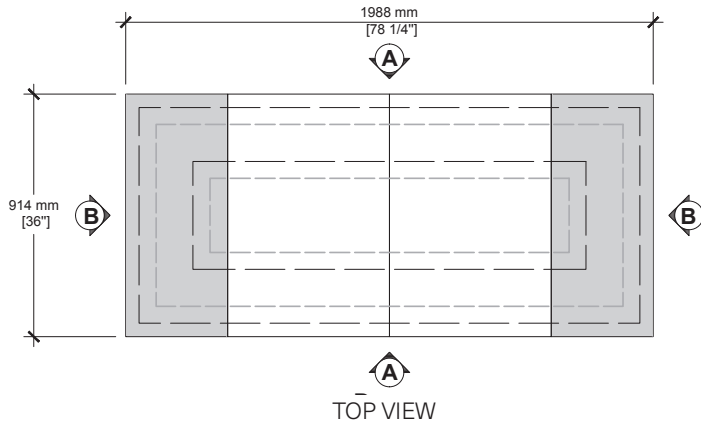

- A. YORK COUNTER TOP 24" X 36" X 2 1/4" (CUT ON FIELD AS REQUIRED)
- B. RÖCKA WALL UNIT (A, B OR C)
- C. RÖCKA WALL UNIT CUT ON FIELD AS REQUIRED
- D. CAST IN PLACE CONCRETE SLAB 4350 psi (30 MPa), 5" (125 mm) THICK
- E. 4X4-4/4 (102X102-MW25.8XMW25.8) WELDED WIRE MESH AND/OR REBAR AS PER SITE CONDITIONS
- F. 12" (300 mm) DIA. CONCRETE PILLAR, AS PER LOCAL CODE
- G. 3/4" (20 mm) CLEAN STONE
- H. 6" (150 mm) THICK MIN. AS PER SITE CONDITIONS
- I. GEOTEXTILE
- I. NATURAL SOIL OR COMPACTED BACKFILL

### QUANTITY OF MATERIALS REQUIRED

- York Counter top 24" x 36" x 2 1/4": **4**
- Röcka wall unit: **22 A, 20 B, 12 C**

**NOTE:** Appliances and utilities may vary for each project and are not shown on this drawing. This drawing is shown for inspiration only and surplus or shortage of materials may result. It is the user's responsibility to verify for the quantity of materials required. Secure the blocks using a heat resistant concrete adhesive. The installer must ensure that the installation and use of the grill island comply with local regulations and code requirements. Concrete pillars extending to frost line may be required as per local code. Check your local building code before installing.



# SANDSTONE

**DESCRIPTION:** Thinset Veneer Wall **TEXTURE:** Natural Stone

## Box Overview

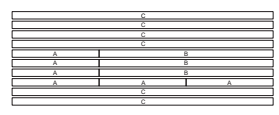

Natural Stone  
Beige

Beige

Natural Stone  
Grey

Grey

## Specifications per pallet

		Imperial	Metric
120 units / pallet	Product dimension (L x D x H) <b>A</b>	7 7/8 x 1 1/6 x 3 15/16	200 x 17 x 100
	Product dimension (L x D x H) <b>B</b>	15 3/4 x 1 1/6 x 3 15/16	400 x 17 x 100
	Product dimension (L x D x H) <b>C</b>	23 5/8 x 1 1/6 x 3 15/16	600 x 17 x 100
60 units / pallet	Cubing*	20 boxes 145.64 ft <sup>2</sup>	20 boxes 13.53 m <sup>2</sup>
	Approx. Weight	1 261 lbs	572 kg
120 units / pallet	Coverage per box*	7.28 ft <sup>2</sup>	0.68 m <sup>2</sup>
	Lin. coverage per box*	20.18 lin. ft	6.15 lin. m

## NOTES

See page 6 for icons description.  
**COMPATIBLE CAPS**  
 See page 145 for product compatibility.  
 See page 146 to 161 for more technical information.  
 \*Cubing including 3/8" (10 mm) joint width

**NATURAL STONE COLLECTION**  
 Natural stones are products of nature. They are sold as is and are not covered by Techo-Bloc's Warranty. Installation is deemed acceptance of products.

# INSTALLATION GUIDE

## THINSET VENEER WALL - SANDSTONE

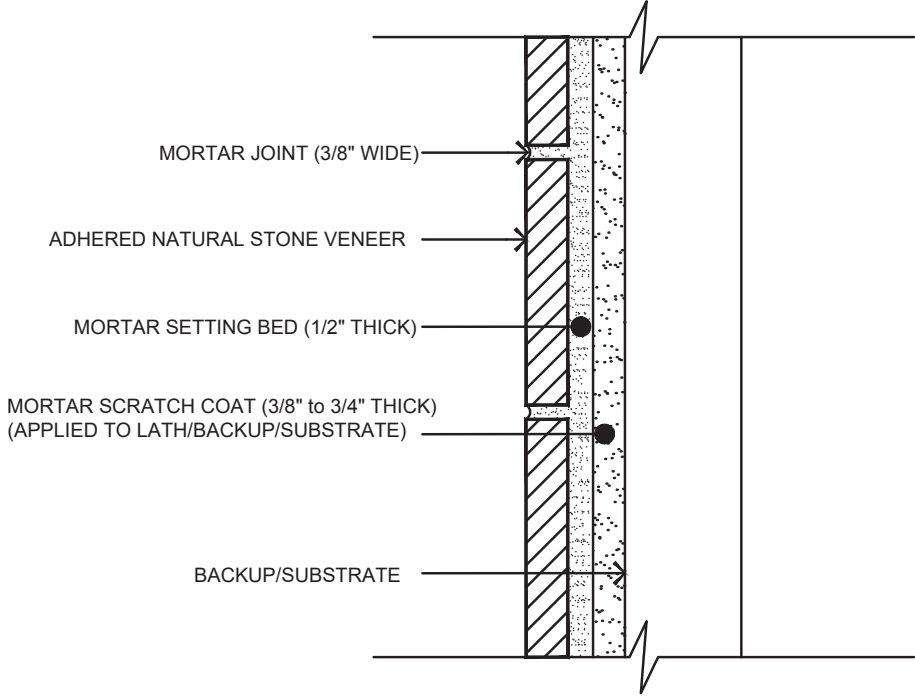



D 

P **PATENT**  
CND 2,114,677  
US 5,528,873

# SEMMA

**DESCRIPTION:** Wall double-sided **TEXTURE:** Split Face

## Pallet Overview

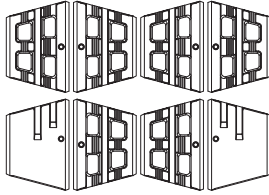



Split Face  
Chestnut Brown

Split Face  
Sandalwood

Split Face  
Champlain Grey

Split Face  
Shale Grey

## Specifications per pallet

	Imperial	Metric
<b>A</b>  REGULAR 30 units / pallet	Dimension Front (L x D x H) <b>A</b> 16 x 11 x 5 7/8	406 x 279 x 150
	Dimension Back (L x D x H) <b>A</b> 10 1/2 x 11 x 5 7/8	266 x 279 x 150
	Dimension Front (L x D x H) <b>B</b> 16 x 11 x 5 7/8	406 x 279 x 150
	Dimension Back (L x D x H) <b>B</b> 10 1/2 x 11 x 5 7/8	266 x 279 x 150
<b>B</b>  CORNER 10 units / pallet	Cubing	40 units / 40 units
		26.25 ft <sup>2</sup> / 2.44 m <sup>2</sup>
		53.33 lin. ft / 16.26 lin. m
	Approx. Weight	2 363 lbs / 1 072 kg
	Number of rows	5
	Coverage per row	5.25 ft <sup>2</sup> / 0.49 m <sup>2</sup>
	Lin. coverage per row	10.67 lin. ft / 3.25 lin. m

## NOTES

See page 6 for icons description.

### COMPATIBLE CAPS

See page 145 for product compatibility.

When building a double-sided wall one pallet will cover an average of 21.74 ft<sup>2</sup>.

The corner units for the Semma block should be glued with a concrete adhesive.

The corner unit can be used as a right or left corner unit and as a regular unit. Metric measures are approximate.

See page 146 to 161 for more technical information.

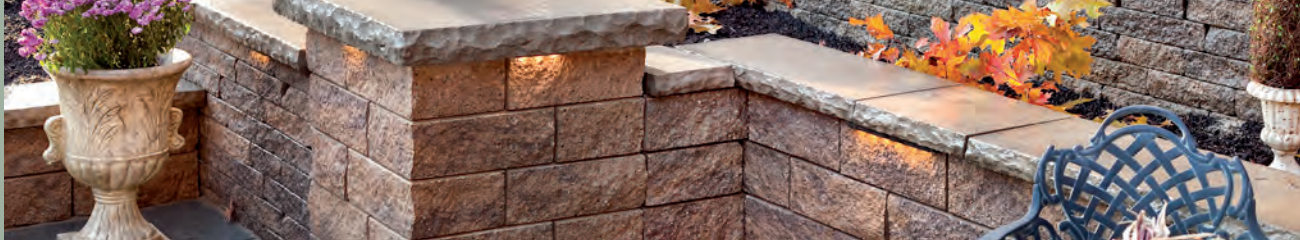

D ❄️

# SEMMA

**DESCRIPTION:** Corner or Pillar **TEXTURE:** Split Face

90 mm

## Specifications per pallet



24 units / pallet  
12 right corners  
12 left corners

	Imperial	Metric
Product dimension (L x D x H)	16 x 10 1/2 x 5 7/8	406 x 266 x 150
Cubing	24 units	24 units
Approx. Weight	1 403 lbs	636 kg
Number of rows	4	
Pillar height	35 7/8 in	900 mm

## Pallet Overview

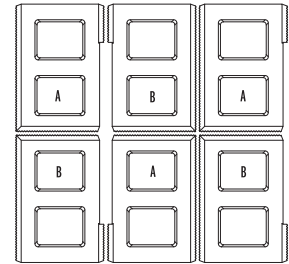

Chestnut Brown

Split Face



Sandlewood

Split Face



Champlain Grey

Split Face

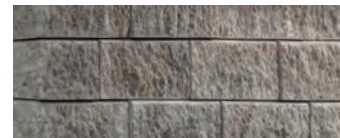

Shale Grey

Split Face



## NOTES

See page 6 for icons description.

### COMPATIBLE CAPS

See page 145 for product compatibility.

See page 146 to 161 for more technical information.

CLEAN SAND/GRAVEL/ SAND AND GRAVEL MIXES ( $\phi=34^\circ$ ,  $\gamma = 120$  pcf)  
GEOGRID: MIRAGRID 3XT BY TENCATE (RFd=1.10, RFcr=1.45, RFid=1.25, Cds=0.9, Ci=0.9)

**CASE N° 1 :**  
No Surcharge  
No Backslope  
No Toe Slope

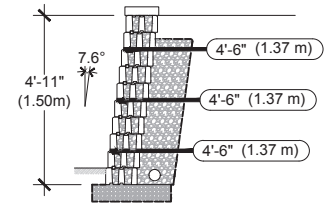
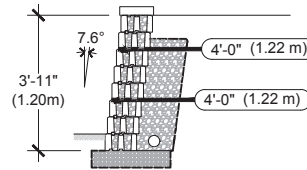
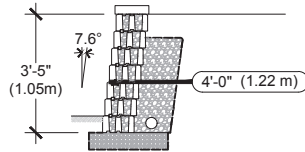
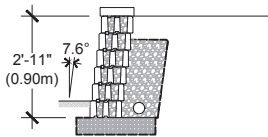

**VISIT [WWW.TECHO-BLOC.COM](http://WWW.TECHO-BLOC.COM) FOR COMPLETE DESIGN CHART DOCUMENT  
(USA AND CANADA VERSIONS)**

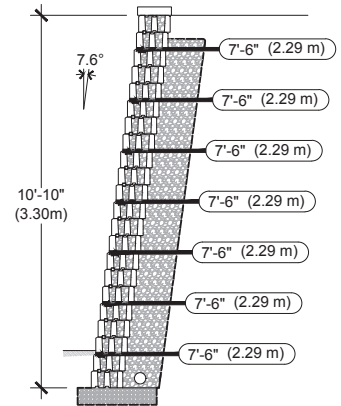
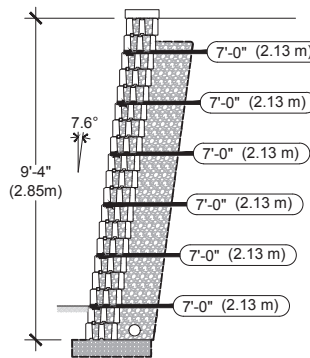
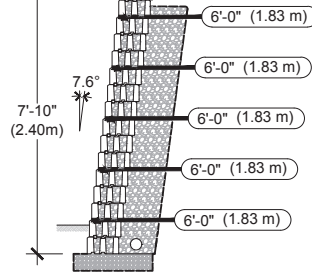
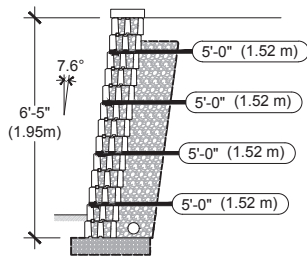

1. The information contained in the design charts is supplied for information purposes only and as such should only be used for preliminary designs.
2. The height (H) of the wall is the total height from the leveling pad to the top of the wall not including the thickness of the cap.
3. Soil parameters: reinforced soil ( $\phi = 34^\circ$ ,  $\gamma = 120$  pcf); retained soil ( $\phi = 34^\circ$ ,  $\gamma = 120$  pcf); foundation soil ( $\phi = 34^\circ$ ,  $\gamma = 120$  pcf)
4. A qualified engineer should be consulted for the final design to be used for construction.
5. The foundation soil must be able to support the wall system. The bearing capacity of the foundation soil, settlement, and global stability must be verified and validated by a qualified geotechnical engineer.
6. The seismic analysis is not included.
7. The design charts do not apply to tiered walls.
8. The charts assume that the walls are constructed in accordance with Techo-Bloc specifications, good construction practice and an adequate drainage system.
9. The geogrid layout has been optimized to satisfy the design requirements of the NCMA's Design Manual for Segmental Retaining Walls, 3rd Edition.
10. The minimum burial depth must be 6 in (150 mm) or 10% of the exposed height, whichever is greater.
11. Engineering judgement should be used when interpolating between heights.
12. Techo-Bloc and its predecessors, successors, beneficiaries, employees, associates, administrators and insurers accepts no liability for the incorrect use of information contained in the design charts.
13. For further information, please contact our technical service department.

# INSTALLATION GUIDE

## FREESTANDING WALLS - SEMMA

### SEMMA

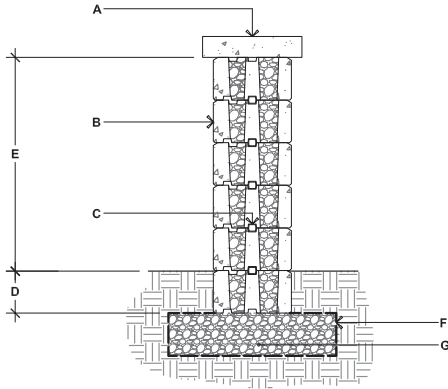

- A. TECO-BLOC CAP UNIT SECURED TO UNIT BELOW WITH CONCRETE ADHESIVE
- B. SEMMA DOUBLE-SIDED WALL UNIT SECURE EACH ROW WITH CONCRETE ADHESIVE
- C. CONNECTOR
- D. EMBEDMENT DEPTH, 6" (150 mm) MIN.
- E. 29 7/16" (750 mm) MAX.
- F. GEOTEXTILE
- G. COMPACTED GRANULAR LEVELING PAD, 6" (150 mm) THICK MIN. THICKNESS ACCORDING TO PROJECT SPECIFIC CONDITIONS

## 90° CORNER OF A DOUBLE-SIDED WALL

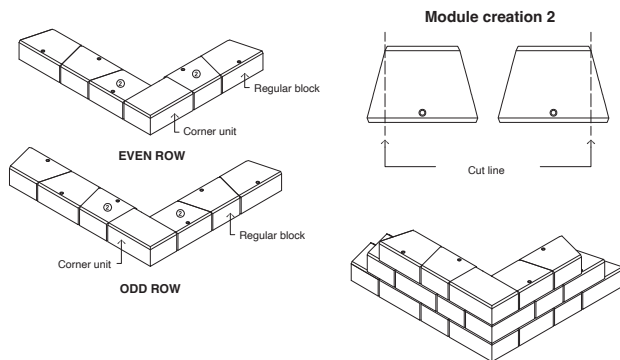

## DOUBLE-SIDED WALL RADIUS

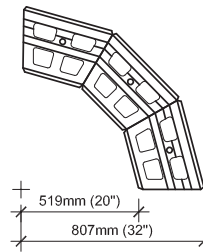

It is the user's responsibility to verify for the quantity of materials required.

## DOUBLE-SIDED WALL - END OF A STRAIGHT WALL

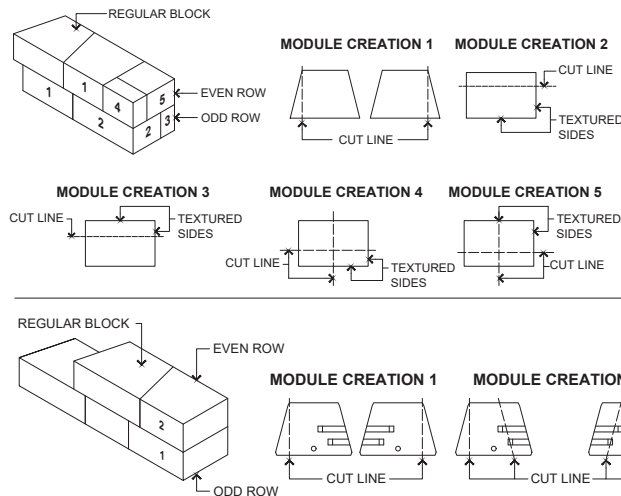

### GENERAL NOTES

1. Alternate odd and even rows.
2. Stagger joints from one row to the next.
3. Glue all modules at each row with concrete adhesive.
4. Cavities, grooves and connectors are not illustrated to avoid overloading the image.

# INSTALLATION GUIDE

## PILLARS - SEMMA

### SEMMA

- A. PILLAR CAP UNIT (SECURE WITH CONCRETE ADHESIVE)
- B. SEMMA PILLAR UNIT SECURE EACH ROW WITH CONCRETE ADHESIVE
- C. EMBEDMENT 6" (150 mm) MIN.
- D. 35 7/8" (900 mm), HEIGHT PER PALLET 47 1/4" (1200 mm), MAXIMUM HEIGHT
- E. GEOTEXTILE
- F. COMPACTED GRANULAR BASE 6" (150mm) THICK MIN. THICKNESS ACCORDING TO PROJECT SPECIFIC CONDITIONS

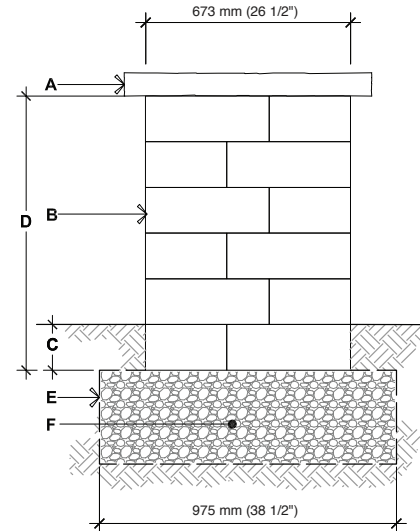

## STEPS

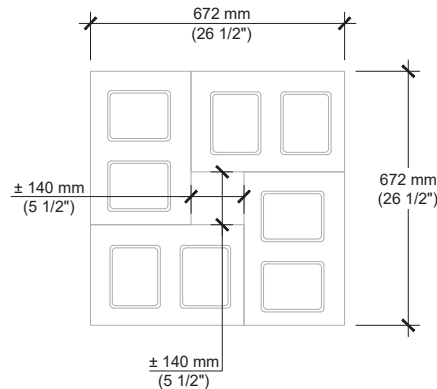
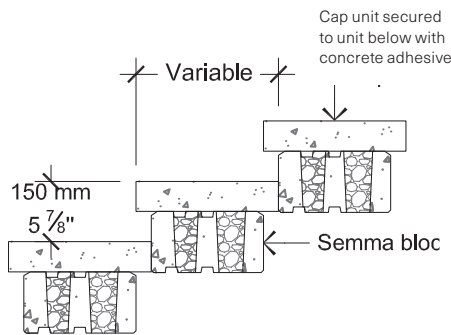

For all possible combinations of pillars and caps, please refer to the correspondence table on page 145.

Check with your local Building Codes to determine any restrictions or guidelines regarding the dimensions of steps (including riser height and step tread) as well as handrail specifications.

## GRAVITY AND REINFORCED WALLS - SEMMA

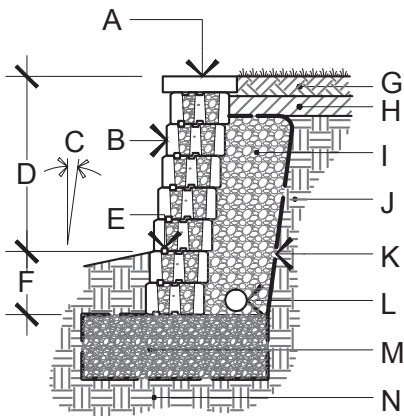

### GRAVITY WALL DETAIL

- A. CAP FROM TECO-BLOC
- B. SEMMA BLOCK FROM TECO-BLOC
- C. WALL INCLINATION (7.6°)
- D. EXPOSED HEIGHT
- E. HDPE HORIZONTAL KEY
- F. EMBEDMENT DEPTH
- G. TOP SOIL
- H. LOW PERMEABILITY SOIL
- I. 3/4" (20 mm) CLEAN STONE, 13" (330 mm) THICK MIN.

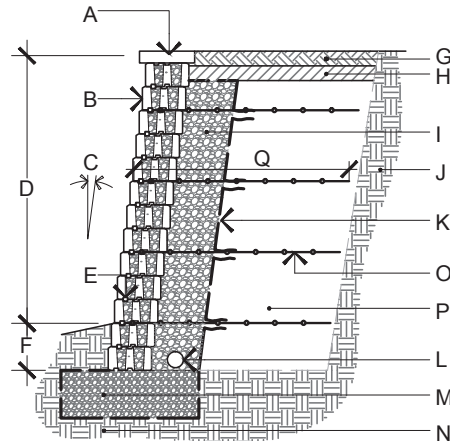

### REINFORCED WALL DETAIL

- J. RETAINED SOIL
- K. GEOTEXTILE
- L. PERFORATED DRAIN
- M. LEVELING PAD
- N. FOUNDATION SOIL
- O. GEOGRID
- P. REINFORCED SOIL
- Q. GEOGRID LENGTH

# INSTALLATION GUIDE

## FIREPIT - SEMMA

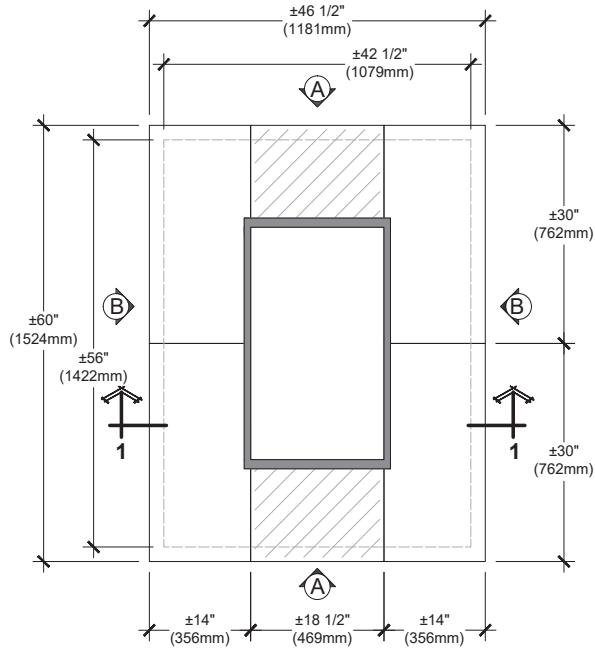

TOP

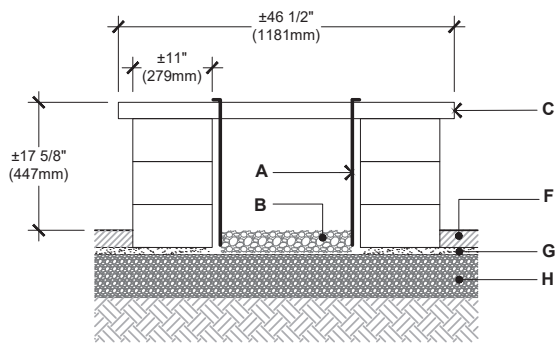

SECTION 1-1

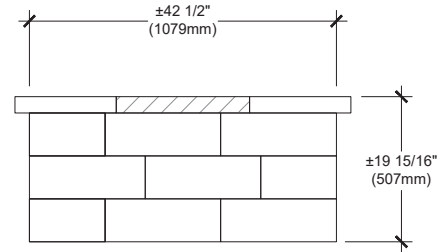

ELEVATION A

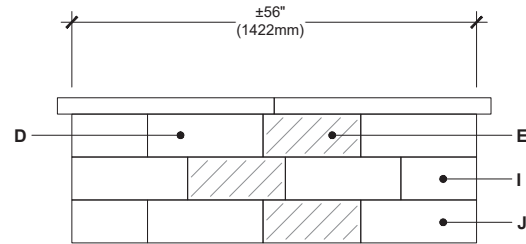

ELEVATION B

 CUT ON FIELD

- A. STEEL BOX INSERT
- B. CLEAN STONE 3/4" (20 mm), 4" (100 mm) THICK
- C. PIEDIMONTE CAP 14"X30" (CUT ON FIELD AS REQUIRED)
- D. SEMMA BLOCK (A OR B UNIT)
- E. SEMMA BLOCK (A OR B UNIT) CUT ON FIELD AS REQUIRED
- F. TECHO-BLOC PAVERS OR SLABS
- G. SETTING BED 1" (25 mm)
- H. COMPACTED GRANULAR 0- 3/4" (0-20 mm)
- I. SEMMA PILLAR UNIT (LEFT CORNER)
- J. SEMMA PILLAR (RIGHT CORNER)

### QUANTITY OF MATERIALS REQUIRED

- Piedimonte Cap (14"x30"): 6
- Semma (A or B): 24
- Semma Pillar: 12 (8 RIGHT CORNER, 4 LEFT CORNERS)

NOTE: Secure the blocks using a heat resistant concrete adhesive. The installer must ensure that the installation and use of the firepit comply with local regulations and code requirements.



# SKYSCRAPER

DESCRIPTION: Wall TEXTURE: Smooth

## Pallet Overview - Top unit

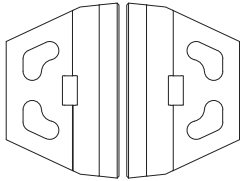

## Pallet Overview - Middle unit

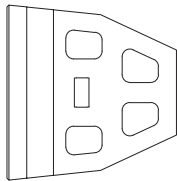

## Pallet Overview - Corner unit

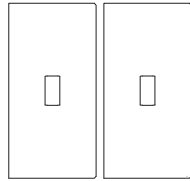

Smooth

Chestnut Brown



Smooth

Shale Grey

## TOP UNIT

### Specifications per pallet



4 units / pallet

	Imperial	Metric
Dimension Front (L x D x H)	36 x 23 1/4 x 12	914 x 590 x 305
Dimension Back (L x D x H)	20 3/8 x 23 1/4 x 12	513 x 590 x 305
Cubing	12.00 ft <sup>2</sup>	1.11 m <sup>2</sup>
	12.00 lin ft	3.66 lin m
Approx. Weight	2 100 lbs	953 kg
Number of rows	2	
Coverage per row	6.00 ft <sup>2</sup>	0.56 m <sup>2</sup>
Linear coverage per row	6.00 lin ft	1.83 lin m

## MIDDLE UNIT

### Specifications per pallet



2 units / pallet

	Imperial	Metric
Dimension Front (L x D x H)	36 x 34 7/8 x 12	914 x 886 x 305
Dimension Back (L x D x H)	17 1/2 x 34 7/8 x 12	444 x 886 x 305
Cubing	6.00 ft <sup>2</sup>	0.56 m <sup>2</sup>
	6.00 lin ft	1.83 lin m
Approx. Weight	1 620 lbs	735 kg
Number of rows	2	
Coverage per row	3.00 ft <sup>2</sup>	0.28 m <sup>2</sup>
Linear coverage per row	3.00 lin ft	0.91 lin m

## CORNER UNIT

### Specifications per pallet



4 units / pallet

	Imperial	Metric
Product dimension (L x D x H)	36 x 18 x 12	914 x 457 x 305
Cubing	4 units	4 units
Approx. Weight	2 460 lbs	1 116 kg
Number of rows	2	

## NOTES

See page 6 for icons description.

### COMPATIBLE CAPS

See page 145 for product compatibility.

Clamp or Mechanical tool available for machine installation. Check with your local Techo-Bloc representative for more information.

See page 146 to 161 for more technical information.



# SKYSCRAPER

DESCRIPTION: Wall TEXTURE: Smooth

## BASE UNIT

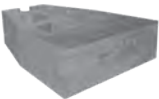
Specifications per pallet	Imperial	Metric	
 2 units / pallet	Dimension Front (L x D x H)	36 x 48 1/8 x 12	914 x 1220 x 305
	Dimension Back (L x D x H)	17 5/8 x 48 1/8 x 12	440 x 1220 x 305
Cubing		6.00 ft <sup>2</sup>	0.56 m <sup>2</sup>
		6.00 lin ft	1.83 lin m
Approx. Weight	1 860 lbs	844 kg	
Number of rows	2		
Coverage per row	3.00 ft <sup>2</sup>	0.28 m <sup>2</sup>	
Linear coverage per row	3.00 lin ft	0.91 lin m	

## EXTENDER UNIT

Specifications per pallet	Imperial	Metric	
 4 units / pallet	Product dimension (L x D x H)	20 1/2 x 24 3/8 x 12	520 x 619 x 305
	Cubing	4 units	4 units
Approx. Weight	1 800 lbs	816 kg	
Number of rows	2		

## Pallet Overview - Base unit

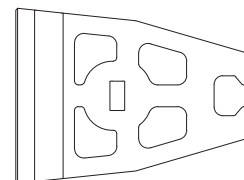

## Pallet Overview - Extender unit

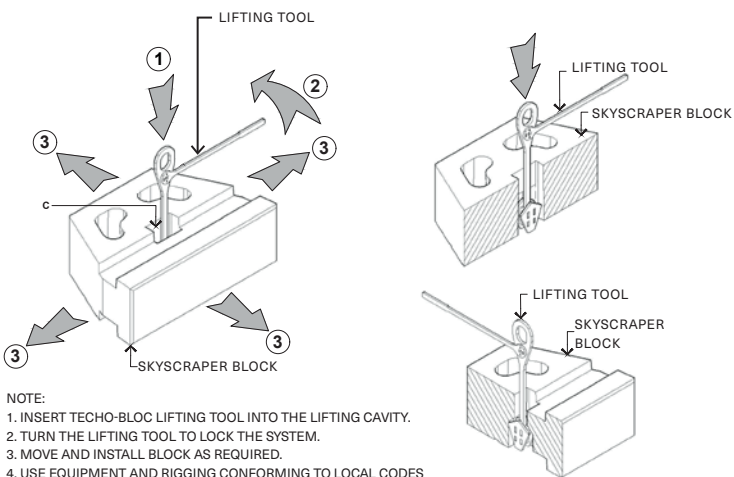
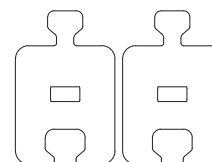

Chestnut Brown

Smooth

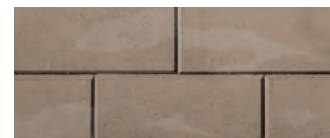

Shale Grey

Smooth

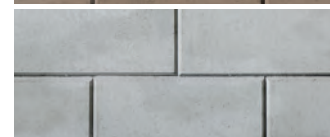

## NOTES

See page 6 for icons description.

### COMPATIBLE CAPS

See page 145 for product compatibility.

See page 146 to 161 for more technical information.

### ALLOWABLE STRESS DESIGN

CLEAN SAND/ SAND AND GRAVEL MIXES ( $\phi=34^\circ$ ,  $\gamma = 130$  pcf)

**CASE N° 1 :**  
No Surcharge  
No Backslope  
No Toe Slope

**5 ft (1.52 m) Total Height**  
T: 5

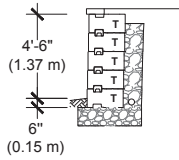

**6 ft (1.83 m) Total Height**  
T: 5  
M: 1

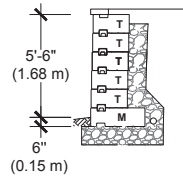

**7 ft (2.13 m) Total Height**  
T: 5  
M: 2

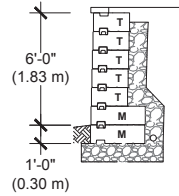

**8 ft (2.44 m) Total Height**  
T: 1  
M: 7

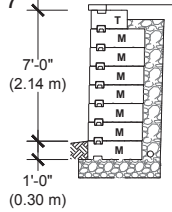

**9 ft (2.74 m) Total Height**  
T: 1  
M: 7  
B: 1

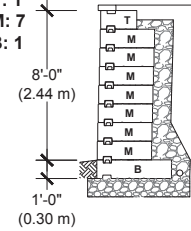

**10 ft (3.05 m) Total Height**  
M: 7  
B: 3

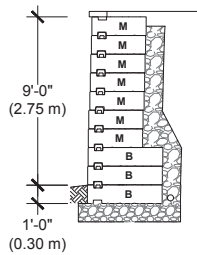

**11 ft (3.35 m) Total Height**  
M: 3  
B: 8

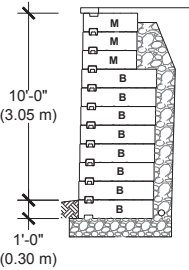

**12 ft (3.66 m) Total Height**  
M: 3  
B: 8  
BE: 1

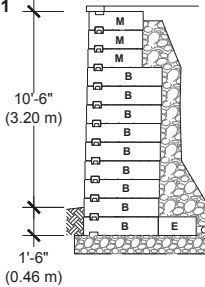

**13 ft (3.96 m) Total Height**  
M: 3  
B: 8  
BE: 2

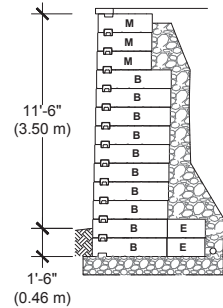

VISIT [WWW.TECHO-BLOC.COM](http://WWW.TECHO-BLOC.COM) FOR COMPLETE DESIGN CHART DOCUMENT  
(USA AND CANADA VERSIONS)

**14 ft (4.27 m) Total Height**  
M: 3  
B: 8  
BE: 3

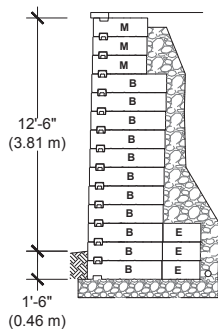

**15 ft (4.57 m) Total**  
B: 12  
BE: 3

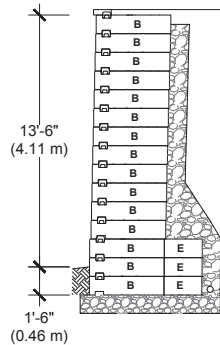

**16 ft (4.88 m) Total Height**  
B: 9  
BE: 7

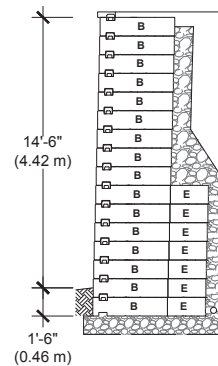

**17 ft (5.18 m) Total Height**  
B: 5  
BE: 12

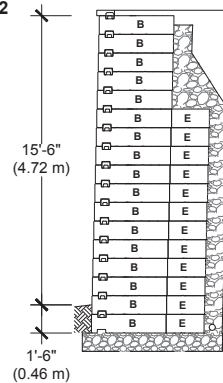

- The information contained in the design charts is supplied for information purposes only and as such should only be used for preliminary designs.
- The height (H) of the wall does not include the thickness of the cap.
- Soil parameters: retained soil ( $\phi = 34^\circ$ ,  $\gamma = 130$  pcf); foundation soil ( $\phi = 34^\circ$ ,  $\gamma = 120$  pcf)
- A qualified engineer should be consulted for the final design to be used for construction.
- The foundation soil must be able to support the wall system. The bearing capacity of the foundation soil, settlement, and global stability must be verified and validated by a qualified geotechnical engineer.
- The seismic analysis is not included.
- The design charts do not apply to tiered walls.
- The charts assume that the walls are constructed in accordance with Techo-Bloc specifications, good construction practice and an adequate drainage system.
- Engineering judgement should be used when interpolating between heights.
- Techo-Bloc and its predecessors, successors, beneficiaries, employees, associates, administrators and insurers accepts no liability for the incorrect use of information contained in the design charts.
- For further information, please contact our technical service department.

#### LEGEND :

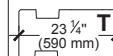

**TOP UNIT**

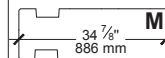

**MIDDLE UNIT**

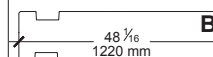

**BASE UNIT**

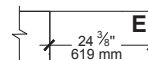

**EXTENDER UNIT**

# INSTALLATION GUIDE

## CAVITY INFILL - SKYSCRAPER

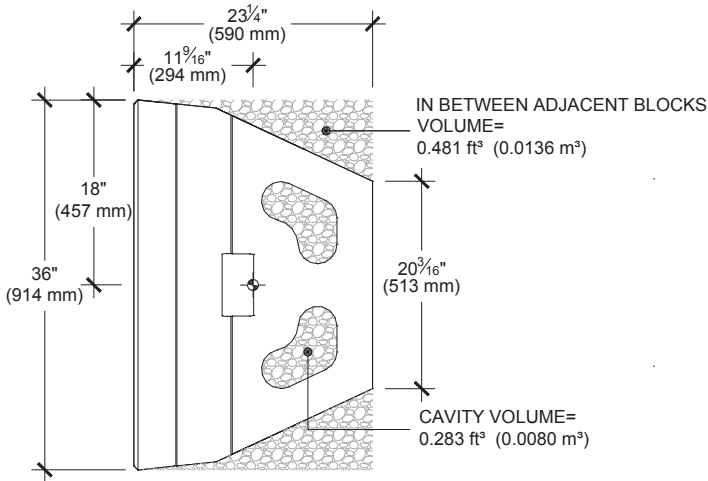

### SKYSCRAPER TOP

AGGREGATE INFILL QUANTITY	PER UNIT	±1.53 ft <sup>3</sup>	(±0.043 m <sup>3</sup> )
		±147.91 lb	(±66.65 kg)
PER WALL AREA		± 0.51 ft <sup>3</sup> /ft <sup>2</sup>	(±0.16 m <sup>3</sup> /m <sup>2</sup> )
		±49.37 lb/ft <sup>2</sup>	(±248 kg/m <sup>2</sup> )

\*Assumed aggregate unit weight of 96.8 lb/ft<sup>3</sup> (1550 kg/m<sup>3</sup>)

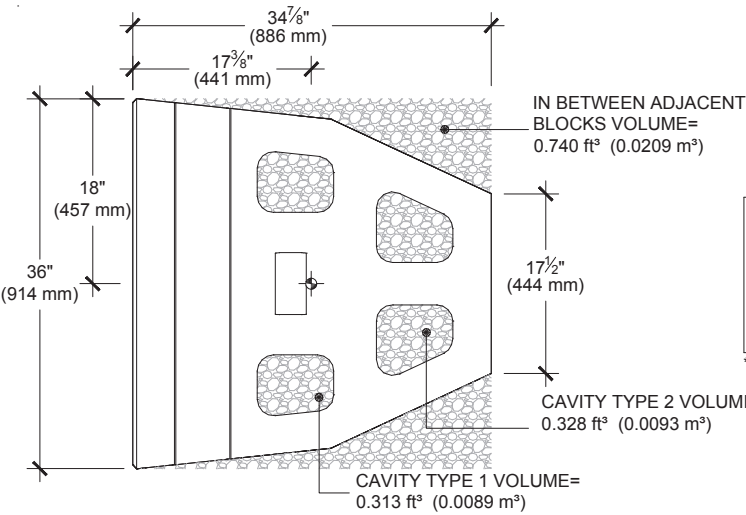

### SKYSCRAPER MIDDLE

AGGREGATE INFILL QUANTITY	PER UNIT	±2.76 ft <sup>3</sup>	(±0.078 m <sup>3</sup> )
		±267.17 lb	(±120.9 kg)
PER WALL AREA		± 0.92 ft <sup>3</sup> /ft <sup>2</sup>	(±0.28 m <sup>3</sup> /m <sup>2</sup> )
		±89.06 lb/ft <sup>2</sup>	(±434 kg/m <sup>2</sup> )

\*Assumed aggregate unit weight of 96.8 lb/ft<sup>3</sup> (1550 kg/m<sup>3</sup>)

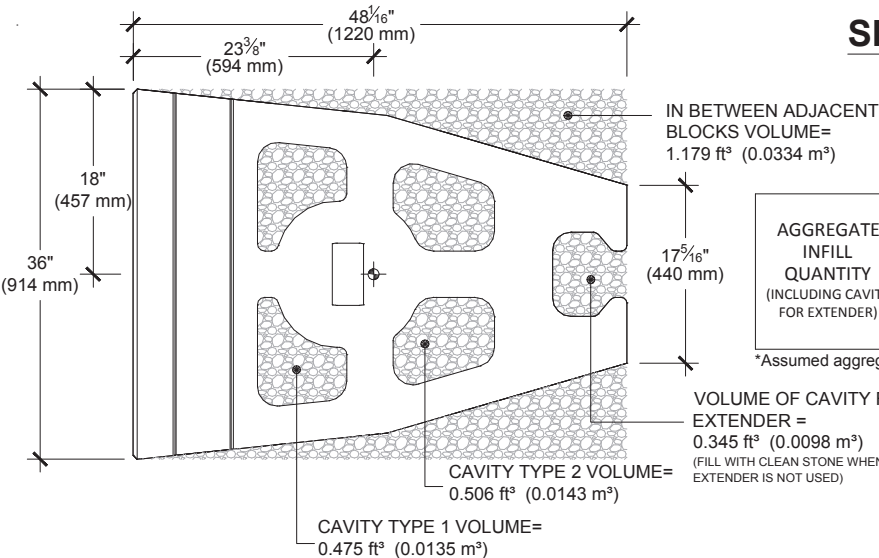

### SKYSCRAPER BASE

AGGREGATE INFILL QUANTITY (INCLUDING CAVITY FOR EXTENDER)	PER UNIT	±4.67 ft <sup>3</sup>	(±0.132 m <sup>3</sup> )
		±452.06 lb	(±204.6 kg)
PER WALL AREA		±1.56 ft <sup>3</sup> /ft <sup>2</sup>	(±0.47 m <sup>3</sup> /m <sup>2</sup> )
		±151.01 lb/ft <sup>2</sup>	(±728.5 kg/m <sup>2</sup> )

\*Assumed aggregate unit weight of 96.8 lb/ft<sup>3</sup> (1550 kg/m<sup>3</sup>)

# INSTALLATION GUIDE

## CAVITY INFILL - SKYSCRAPER

### SKYSCRAPER BASE + EXTENDER(S)

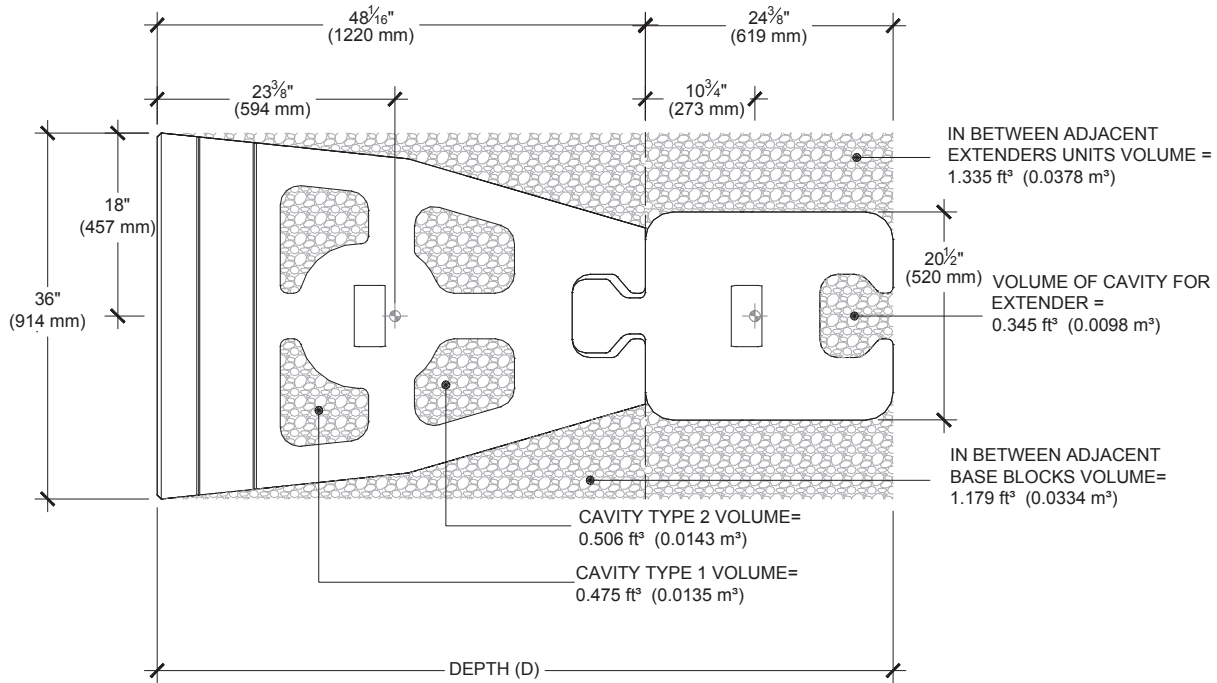

**Aggregate Infill Quantity**  
(INCLUDING CAVITY FOR EXTENDER)

# OF EXTENDERS	DEPTH (D)		PER UNIT				PER WALL AREA			
1	72 3/8 "	1839 mm	±7.35 ft <sup>3</sup>	(±0.208 m <sup>3</sup> )	±711 lb	(±322 kg)	±2.45 ft <sup>3</sup> /ft <sup>2</sup>	(± 0.75 m <sup>3</sup> /m <sup>2</sup> )	±237 lb/ft <sup>2</sup>	(±1163 kg/m <sup>2</sup> )
2	96 3/4 "	2458 mm	±10.02 ft <sup>3</sup>	(±0.283 m <sup>3</sup> )	±970 lb	(±439 kg)	±3.34 ft <sup>3</sup> /ft <sup>2</sup>	(± 1.02 m <sup>3</sup> /m <sup>2</sup> )	±323 lb/ft <sup>2</sup>	(±1581 kg/m <sup>2</sup> )
3	121 1/8 "	3077 mm	±12.69 ft <sup>3</sup>	(±0.359 m <sup>3</sup> )	±1228 lb	(±556 kg)	±4.23 ft <sup>3</sup> /ft <sup>2</sup>	(± 1.29 m <sup>3</sup> /m <sup>2</sup> )	±409 lb/ft <sup>2</sup>	(±2000 kg/m <sup>2</sup> )
4	145 1/2 "	3696 mm	±15.36 ft <sup>3</sup>	(±0.435 m <sup>3</sup> )	±1487 lb	(±674 kg)	±5.12 ft <sup>3</sup> /ft <sup>2</sup>	(± 1.56 m <sup>3</sup> /m <sup>2</sup> )	±496 lb/ft <sup>2</sup>	(±2418 kg/m <sup>2</sup> )
5	169 7/8 "	4315 mm	±18.03 ft <sup>3</sup>	(±0.510 m <sup>3</sup> )	±1745 lb	(±791 kg)	±6.01 ft <sup>3</sup> /ft <sup>2</sup>	(± 1.83 m <sup>3</sup> /m <sup>2</sup> )	±582 lb/ft <sup>2</sup>	(±2837 kg/m <sup>2</sup> )
6	194 1/4 "	4934 mm	±20.70 ft <sup>3</sup>	(±0.586 m <sup>3</sup> )	±2004 lb	(±908 kg)	±6.9 ft <sup>3</sup> /ft <sup>2</sup>	(± 2.1 m <sup>3</sup> /m <sup>2</sup> )	±668 lb/ft <sup>2</sup>	(±3255 kg/m <sup>2</sup> )

\*Assumed aggregate unit weight of 96.8 lb/ft<sup>3</sup> (1550 kg/m<sup>3</sup>)

# INSTALLATION GUIDE

## GRAVITY WALLS - SKYSCRAPER

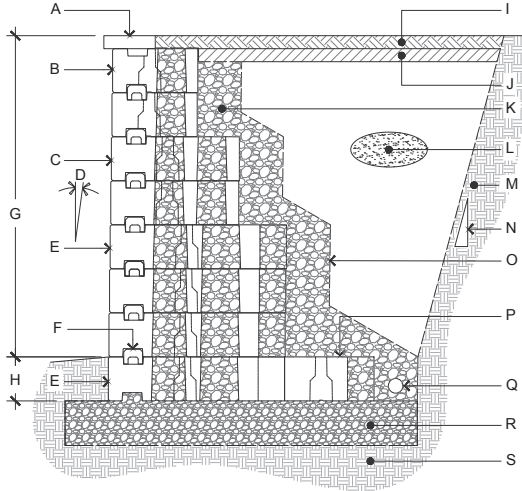

**GRAVITY NEAR VERTICAL WALL DETAIL**

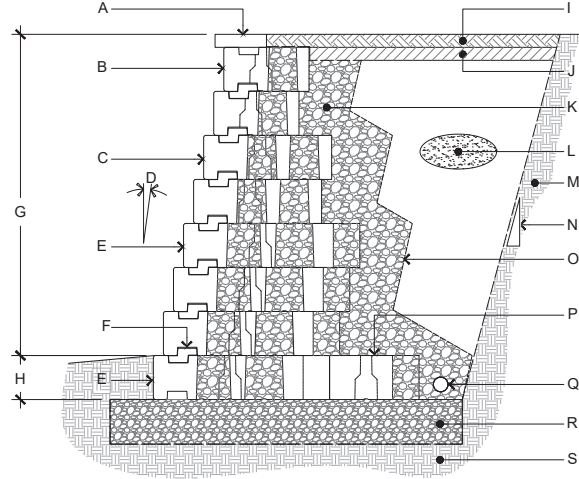

**GRAVITY NEAR INCLINED WALL DETAIL**

**A.** CAP FROM TECHO-BLOC

**B.** SKYSCRAPER TOP UNIT FROM TECHO-BLOC

**C.** SKYSCRAPER MIDDLE UNIT FROM TECHO-BLOC

**D.** WALL INCLINATION: 0.8° (NEAR VERTICAL)  
12.7° (INCLINED)

**E.** SKYSCRAPER BASE UNIT FROM TECHO-BLOC

**F.** PRECAST CONCRETE "U" CONNECTOR

**G.** EXPOSED HEIGHT

**H.** EMBEDMENT DEPTH

**I.** TOP SOIL

**J.** LOW PERMEABILITY SOIL

**K.** ¾" (20 mm) CLEAN STONE, 12" (300 mm) THICK MIN

**L.** COMPACTED BACKFILL

**M.** RETAINED SOIL

**N.** EXCAVATION ACCORDING TO LOCAL SAFETY  
REGULATIONS

**O.** GEOTEXTILE

**P.** SKYSCRAPER EXTENDER UNIT FROM TECHO-BLOC

**Q.** PERFORATED DRAIN

**R.** LEVELING PAD

**S.** FOUNDATION SOIL



(Available Spring 2026) **SYSTEMA**

**DESCRIPTION:** Wall **TEXTURE:** Smooth

**Pallet Overview**

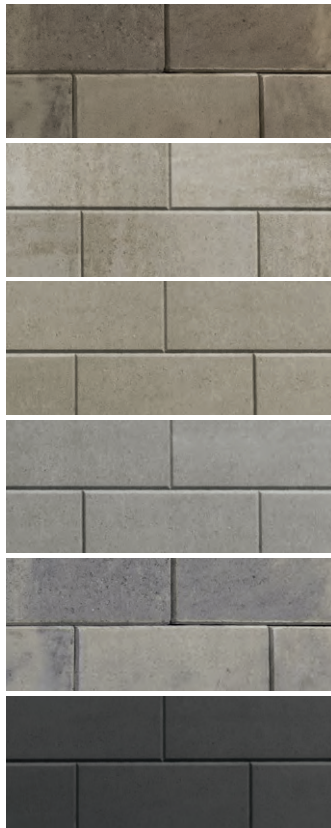
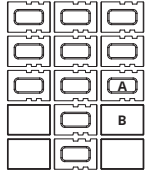

Smooth Chestnut Brown  
Smooth Caffè Crema  
Smooth Beige Cream  
Smooth Greyed Nickel  
Smooth Shale Grey  
Smooth Onyx Black

**Specifications per pallet**



A - 22 units / pallet



B - 8 units / pallet

	Imperial	Metric
Dimension Front (L x D x H) <b>A</b>	14 x 10 x 7 1/16	356 x 254 x 180
Dimension Back (L x D x H) <b>A</b>	14 x 10 x 7 1/16	356 x 254 x 180
Dimension Front (L x D x H) <b>B</b>	14 x 10 x 7 1/16	356 x 254 x 180
Dimension Back (L x D x H) <b>B</b>	14 x 10 x 7 1/16	356 x 254 x 180
Cubing	30 units	30 units
	20.69 ft <sup>2</sup>	1.92 m <sup>2</sup>
Approx. Weight	1 918 lbs	870 kg
Number of rows	2	
Coverage per row	10.35 ft <sup>2</sup>	0.96 m <sup>2</sup>
Lin. coverage per row	17.5 lin. ft	5.34 lin. m

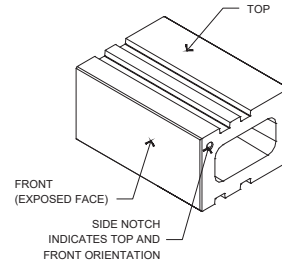

**NOTES**

See page 6 for icons description.

**COMPATIBLE CAPS**

See page 145 for product compatibility.

NOTE: PALLETIZED UPRIGHT

See page 146 to 161 for more technical information.

# INSTALLATION GUIDE

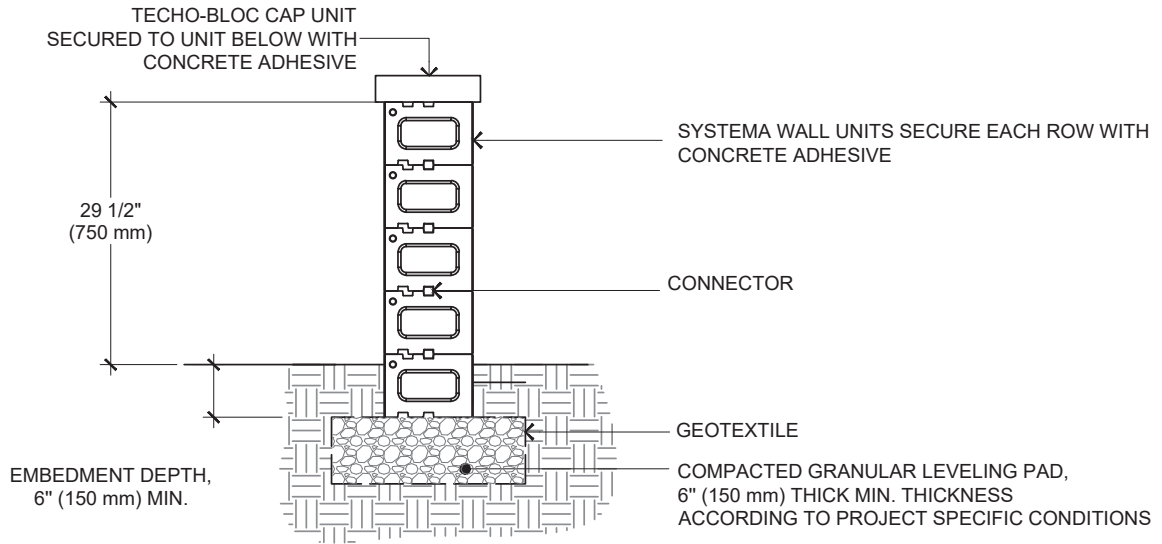

## FREESTANDING WALL

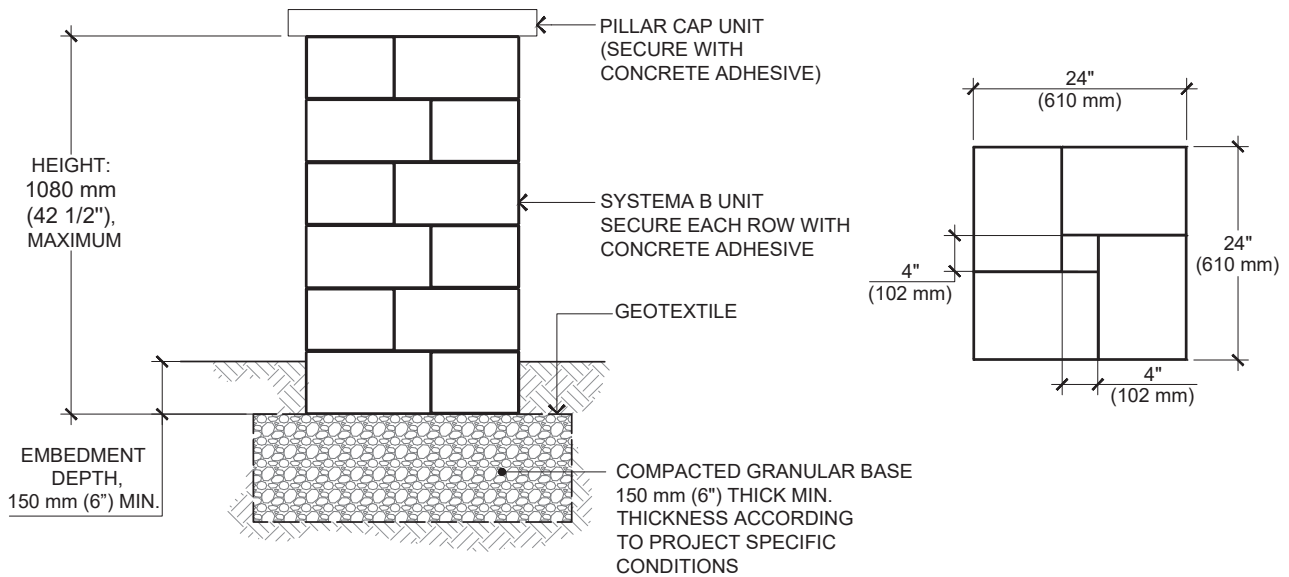

## PILLAR

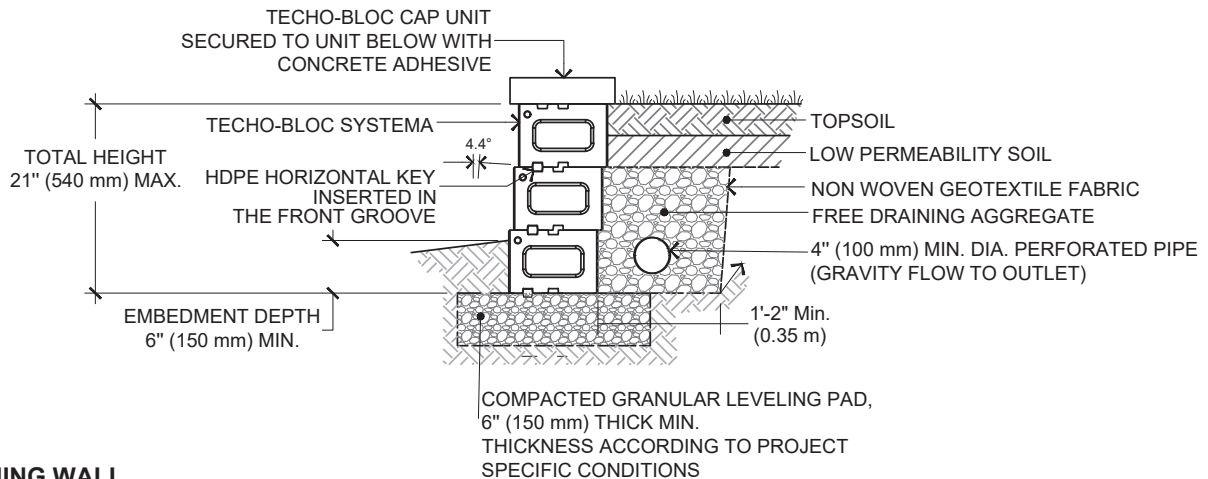

## RETAINING WALL



# TRAVERTINA RAW

**DESCRIPTION:** Double-sided wall **TEXTURE:** Brushed Travertine

## Pallet Overview

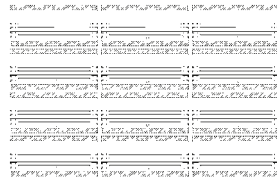

## Specifications per pallet



48 units / pallet

	Imperial	Metric
Product dimension (L x D x H)	15 7/8 x 7 15/16 x 6	403 x 202 x 152
Cubing	31.75 ft <sup>2</sup>	2.95 m <sup>2</sup>
	63.5 lin. ft	19.36 lin. m
Approx. Weight	2 902 lbs	1 316 kg
Number of rows	4	
Coverage per units	0.66 ft <sup>2</sup>	0.06 m <sup>2</sup>
Coverage per row	7.94 ft <sup>2</sup>	0.74 m <sup>2</sup>
Linear coverage per row	15.88 lin. ft	4.84 lin. m



Brushed Travertine  
Rock Garden Brown

Brushed Travertine  
Ivory

Brushed Travertine  
Riviera

## NOTES

See page 6 for icons description.

### COMPATIBLE CAPS

See page 145 for product compatibility.

The dimensional tolerance for Stonedge wet cast retaining wall units is: + 3/16" (5 mm) for height and + 1/2" (13 mm) for length and width. During the installation, the level between adjacent wall units will vary (usually more than for a dry cast wall unit) in order to obtain a more realistic appearance of a natural stone wall.

See page 146 to 161 for more technical information.



# TRAVERTINA RAW

**DESCRIPTION:** Corner/Pillar **TEXTURE:** Brushed Travertine

Specifications per pallet	Imperial	Metric
 Product dimension (L×D×H)	15 7/8 × 7 15/16 × 6	403 × 202 × 152
Cubing	24 units	24 units
Approx. Weight	1 576 lbs	715 kg
24 units / pallet	Number of rows	2
Pillar height	36 in	914 mm

## Pallet Overview



## NOTES

See page 6 for icons description.

See page 146 to 161 for more technical information.

### COMPATIBLE CAPS

See page 145 for product compatibility.

The dimensional tolerance for Stonedge wet cast retaining wall units is: + 3/16" (5 mm) for height and + 1/2" (13 mm) for length and width. During the installation, the level between adjacent wall units will vary (usually more than for a dry cast wall unit) in order to obtain a more realistic appearance of a natural stone wall.

# INSTALLATION GUIDE

## FREESTANDING WALLS - TRAVERTINA RAW

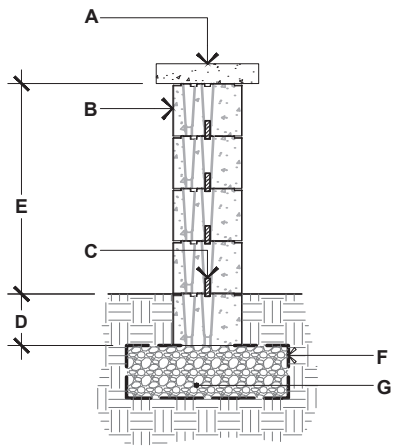

### TRAVERTINA RAW

- A. TECHO-BLOC CAP UNIT, SECURED TO UNIT BELOW WITH CONCRETE ADHESIVE
- B. TRAVERTINA RAW DOUBLE-SIDED WALL UNIT SECURE EACH ROW WITH CONCRETE ADHESIVE
- C. CONNECTOR
- D. EMBEDMENT DEPTH, 6" (150 mm) MIN.
- E. 24" (612 mm) MAX.
- F. GEOTEXTILE
- G. COMPACTED GRANULAR LEVELING PAD, 6" (150 mm) THICK MIN. THICKNESS ACCORDING TO PROJECT SPECIFIC CONDITIONS

## 90° CORNER OF A DOUBLE-SIDED WALL

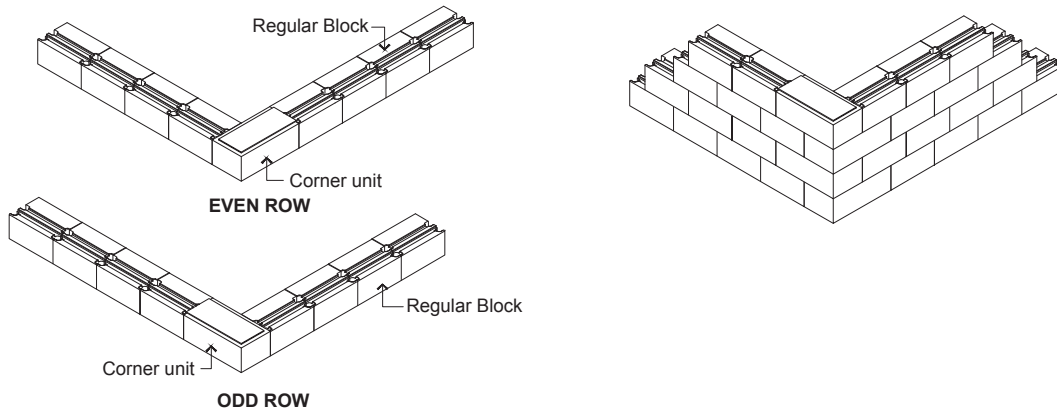

## DOUBLE-SIDED WALL - END OF A STRAIGHT WALL

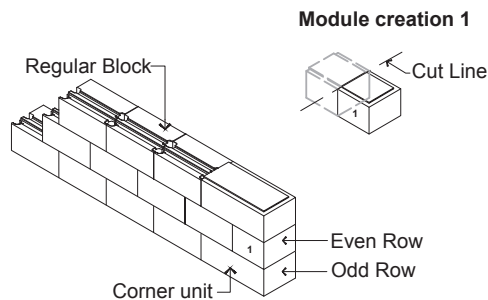

### GENERAL NOTES

1. Alternate odd and even rows.
2. Stagger joints from one row to the next.
3. Glue all modules at each row with Flexlock adhesive.

# INSTALLATION GUIDE

## PILLARS - TRAVERTINA RAW

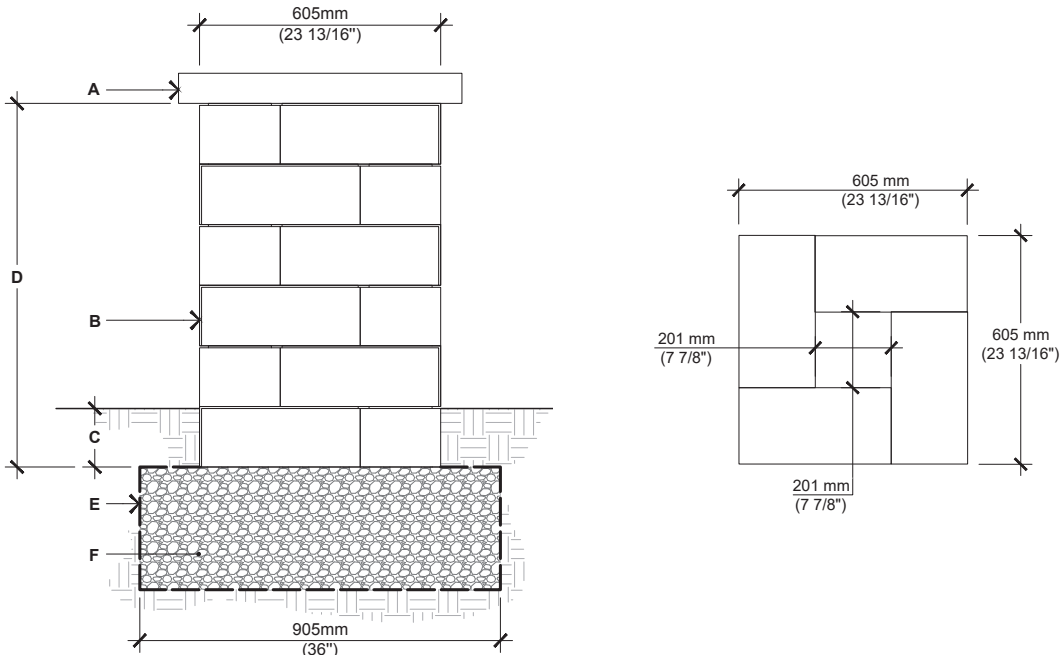

### ○ TRAVERTINA RAW

- A. PILLAR CAP UNIT  
(SECURE WITH CONCRETE ADHESIVE)
- B. TRAVERTINA RAW PILLAR UNIT  
SECURE EACH ROW WITH CONCRETE ADHESIVE
- C. EMBEDMENT 6" (150 mm) MIN.
- D. 36" (917 mm), HEIGHT PER PALLET  
42" (1067 mm), MAXIMUM HEIGHT
- E. GEOTEXTILE
- F. COMPACTED GRANULAR BASE 6" (150mm)  
THICK MIN. THICKNESS ACCORDING TO  
PROJECT SPECIFIC CONDITIONS

For all possible combinations of pillars and caps, please refer to the correspondence table on page 145

## STEPS

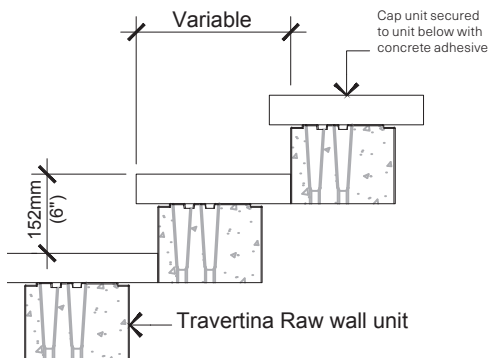

For all possible combinations of walls and caps, please refer to the correspondence table on page 145

Check with your local Building Codes to determine any restrictions or guidelines regarding the dimensions of steps (including riser height and step tread) as well as handrail specifications.

# STEPS & CAPS

STEPS, CAPS (WALLS, COUNTERS AND PILLARS),  
POOL COPING & OVERLAY SYSTEMS



## STEPS

Borealis	P. 251
Maya	P. 252
Raffinato	P. 253
Röcka	P. 254
Sandstone	P. 255
Systema	P. 256
Terrazzo	P. 257
York	P. 258

## OVERLAY SYSTEMS

Blu 45 mm	P. 260
Sandstone	P. 261
Venetian	P. 262

## CAPS

Architectural	P. 264
Bali Travertina Raw	P. 266
Brandon	P. 267
Limestone	P. 268
Sandstone	P. 269
Bullnose	P. 270
Bullnose Grande	P. 271
Graphix	P. 272
Piedimonte	P. 273
Portofino	P. 274
Raffinato	P. 276
Terrazzo	P. 278
Travertina Raw	P. 279
York	P. 280

# COMPATIBILITY CHART

Walls & Pillars	Caps																				
	Architectural	Brandon	Bullnose	Bullnose Grande	Graphix	Limestone	Piedimonte	Piedimonte 28"x28"	Portofino	Raffinato 60 mm	Raffinato 90 mm	Sandstone	Sandstone Bullnose	Sandstone Overlay	Terrazzo	Terrazzo Bullnose	Travertina Raw 14"x28"	York	York 28"x28"	York 32"x32"	
Borealis (does not require a cap)																					
Brandon 90 & 180 mm		x	x	x		x	x		x	x	x	x	x	x	x	x	x	x			
Brandon 90 & 180 mm pillar						x		x		x	x	x					x		x		
Fascia Wall Collection - single-sided	x	x	x	x	x	x	x		x	x	x	x	x	x	x	x	x	x			
Fascia Wall Collection - double-sided									x												
G-Force						x	x	x		x	x	x			x	x	x				
Graphix					x	x	x			x	x	x		x	x	x	x				
Mini-Creta Collection	x	x	x	x		x	x		x	x	x	x	x	x	x	x	x	x			
Mini-Creta Pillar 24" Collection						x		x		x	x	x					x		x		
Prescott Collection						x	x		x	x	x	x		x	x	x	x	x			
Prescott Pillar Collection						x		x		x	x	x					x		x		
Raffinato Collection				x	x	x	x			x	x	x	x	x	x	x	x				
Raffinato Pillar Collection						x		x		x	x	x					x				
Röcka (does not require a cap)																					
Semma	x	x	x		x	x	x		x	x	x	x		x	x	x	x	x			
Semma Pillar										x		x					x				x
Skyscraper										x	x	x		x	x	x					
Systema				x	x	x	x			x	x	x	x	x	x	x	x				
Travertina Raw	x	x	x	x	x	x	x		x	x	x	x	x	x	x	x	x	x			
Travertina Raw pillar										x	x	x					x		x		

NOTE: The combinations shown in this chart are not exclusive. Other combinations can be possible.

Applications	Caps																									
	Architectural	Bali Travertina Raw	Brandon	Bullnose	Bullnose Grande	Graphix	Limestone	Piedimonte 14"x30"	Piedimonte 28"x28"	Portofino	Raffinato 60 mm	Raffinato 90 mm	Sandstone	Sandstone Bullnose	Sandstone Overlay	Terrazzo	Terrazzo Bullnose	Travertina Raw 14"x28"	York wall caps 16", 32", 48"	York 14"x48"	York 24"x36"	York 28"x28"	York 32"x32"	Blu 45 mm	Venetian	
Step	x		x	x	x	x	x		x	x	x	x	x		x	x	x	x	x	x						
Concrete & step overlay system															x										x	x
Pool coping		x		x	x		x		x	x	x	x	x	x	x	x	x	x	x							
Wall single-sided	x		x	x	x	x	x		x	x	x	x	x	x	x	x	x	x	x							
Wall double-sided	x					x	x		x	x	x	x						x	x	x						
Counter top							x	x									x									
Pillar								x		x								x				x	x	x		

# INSTALLATION GUIDE

## POOL COPING

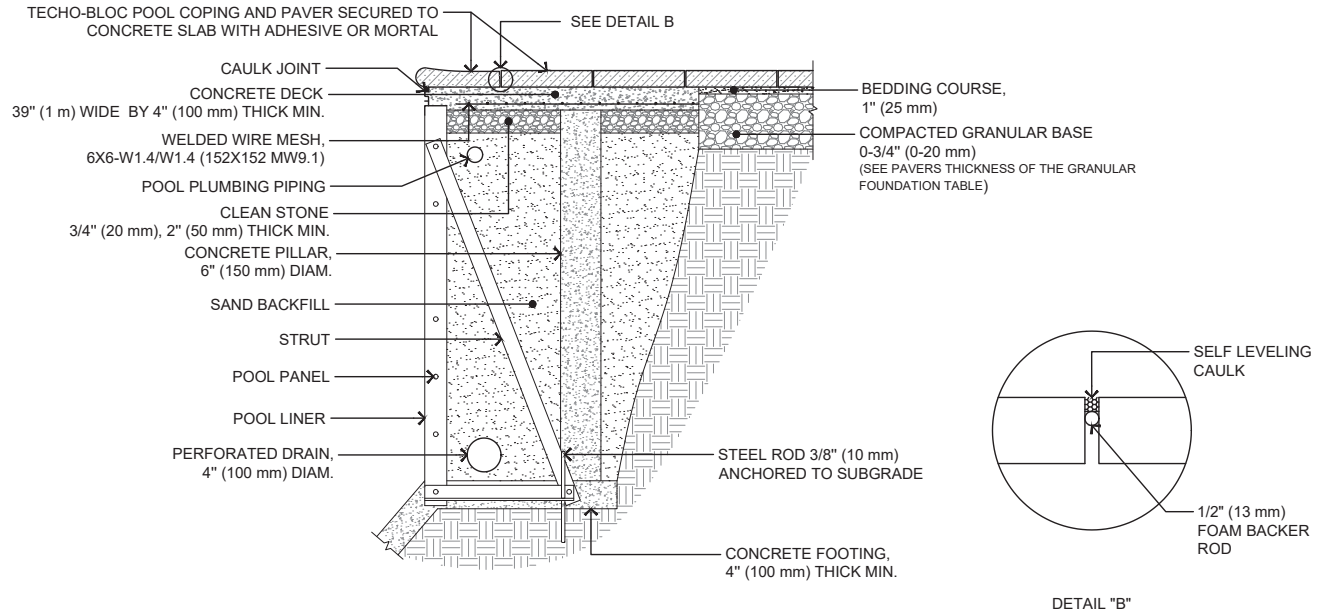

 POOL COPING INSTALLATION  
Typical cross section

## NATURAL STONE COPING

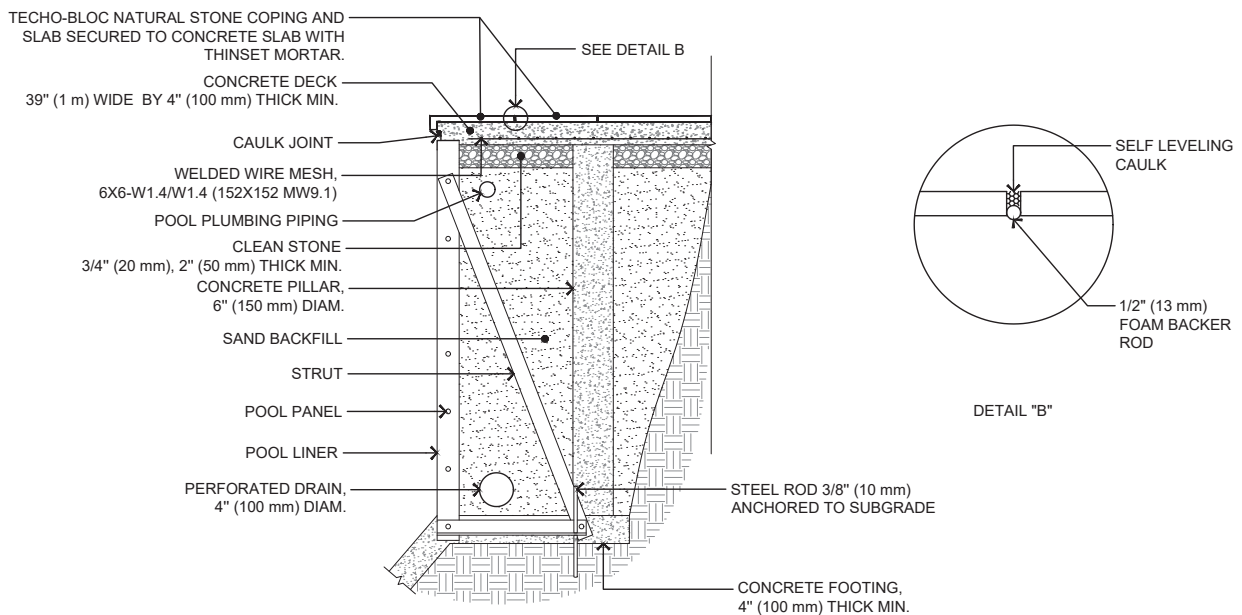

# INSTALLATION GUIDE

## OVERLAY OF EXISTING CONCRETE STEPS VENETIAN CAP, RISER AND SLAB BLU 45 mm

### OPTION 1: 7" (178 mm) HIGH RISER

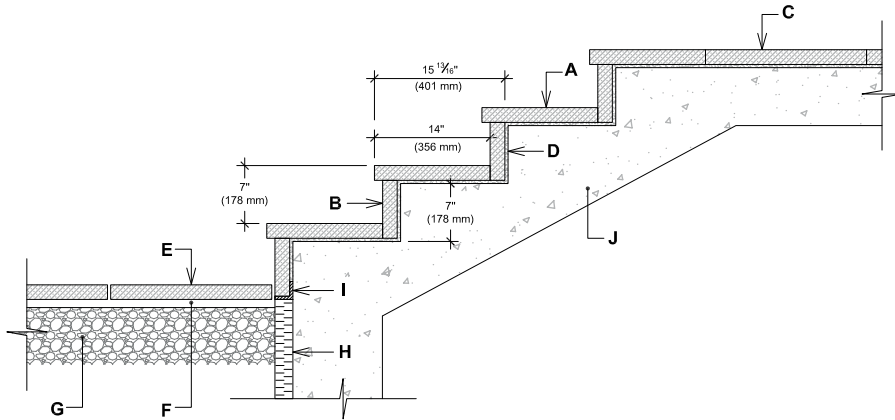

- A. Venetian Cap
- B. Venetian Riser (cut if the riser height is less than 7")
- C. Blu 45 mm Slab (3 sizes)
- D. concrete Adhesive
- E. Techo-Bloc Pavers or Slabs
- F. Setting bed
- G. Compacted granular base 0-3/4" (0-20 mm)
- H. Rigid insulation
- I. Steel angle anchored to concrete
- J. Concrete stairway

### STEP OVERLAY SYSTEM INSTALLATION

Typical cross section

### OPTION 2: 5 7/8" (150 mm) TO 7 7/8" (200 mm) HIGH RISER

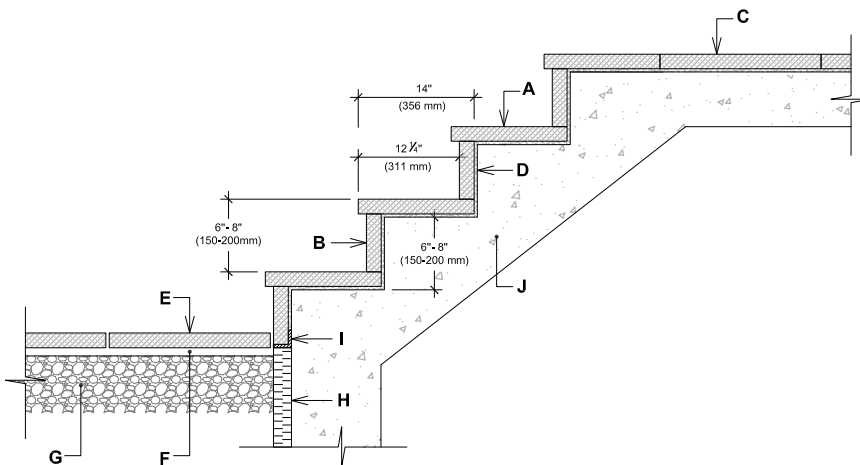

- A. Venetian Cap
- B. Sawn Venetian Riser (depending on the height of the riser)
- C. Blu 45 mm Slab (3 sizes)
- D. Concrete Adhesive
- E. Techo-Bloc Pavers or Slabs
- F. Setting bed
- G. Compacted granular base 0-3/4" (0-20 mm)
- H. Rigid insulation
- I. Steel angle anchored to concrete
- J. Concrete stairway

### STEP OVERLAY SYSTEM INSTALLATION

Typical cross section

# INSTALLATION GUIDE

## BOREALIS

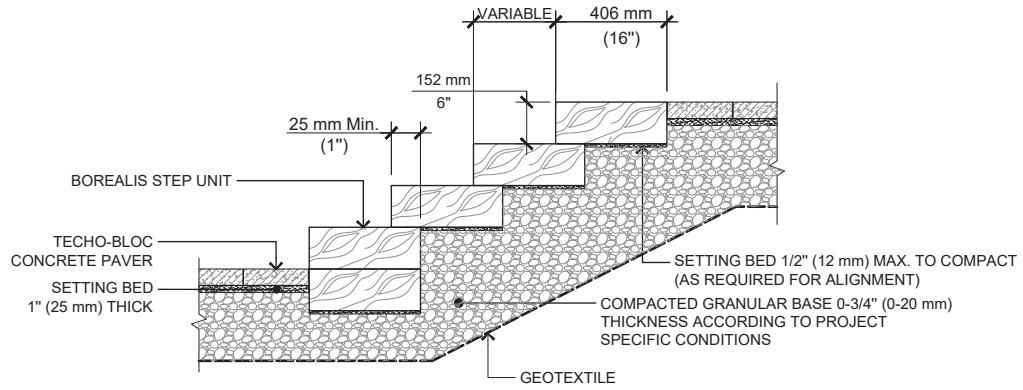

## MAYA

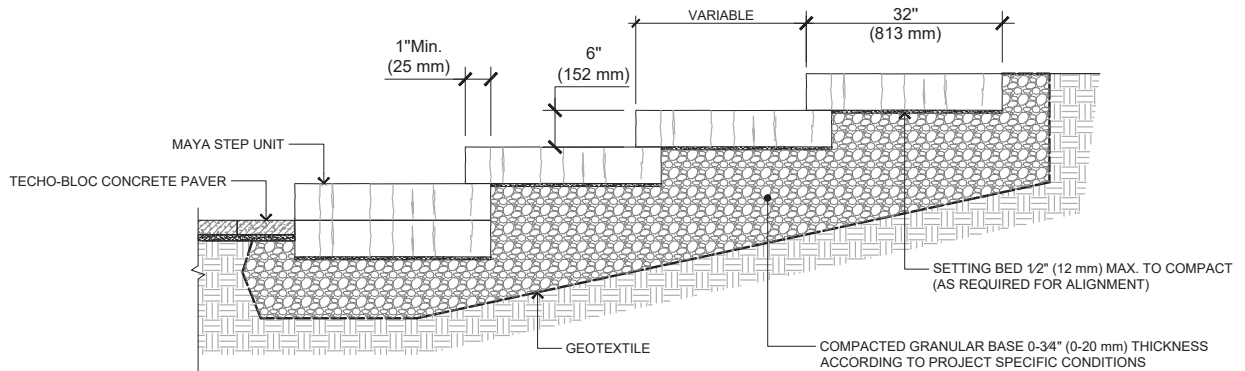

## RAFFINATO

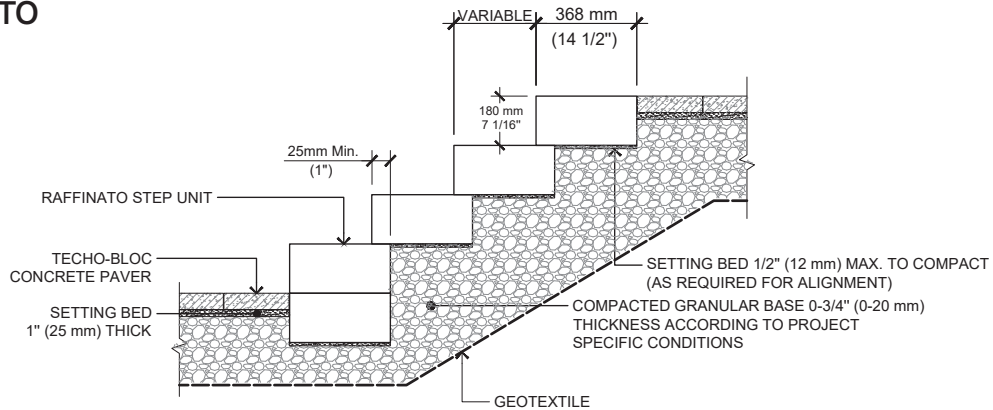

# INSTALLATION GUIDE

## RÖCKA

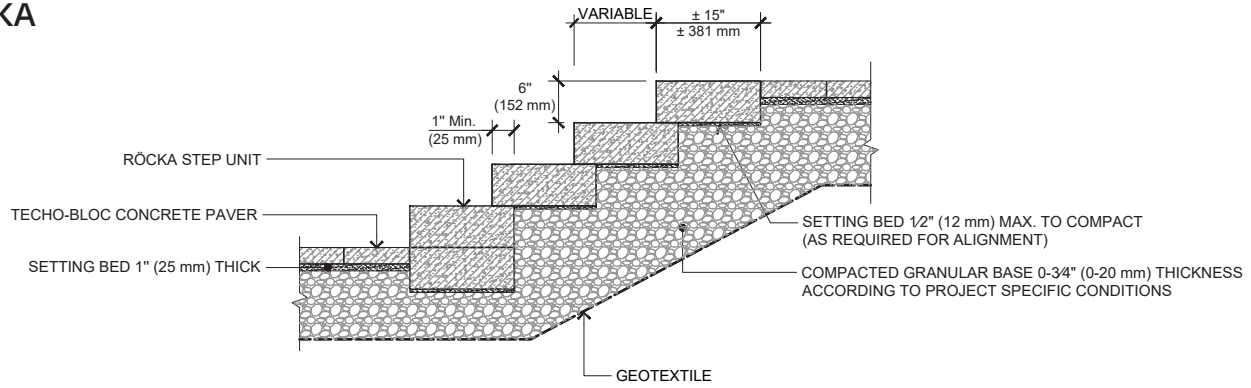

## SANDSTONE

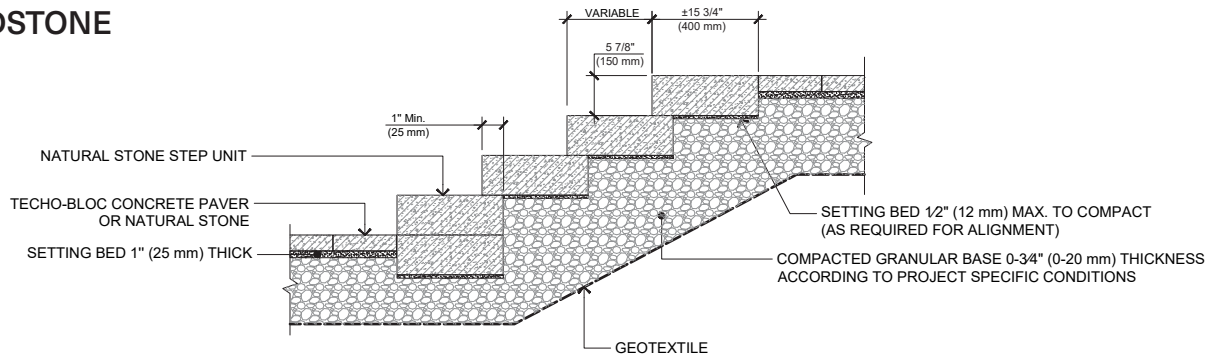

## SYSTEMA

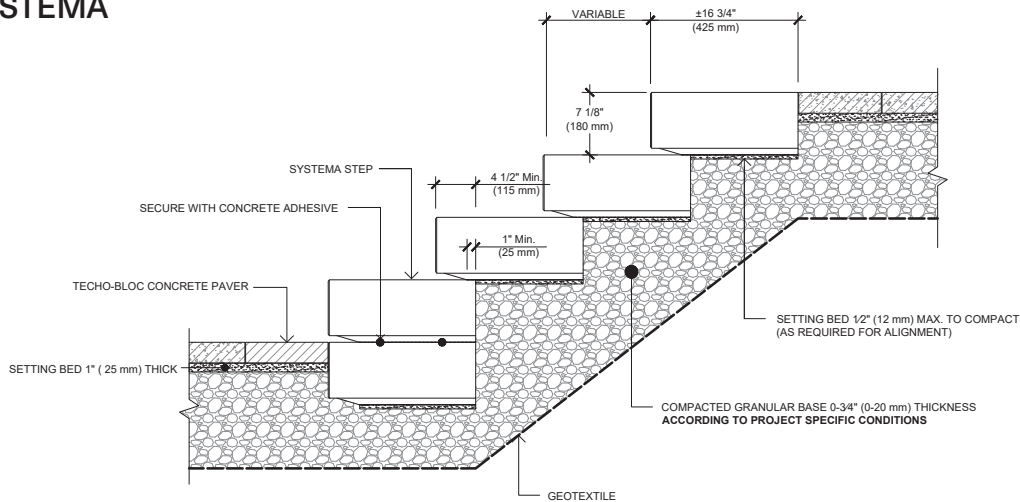

## YORK

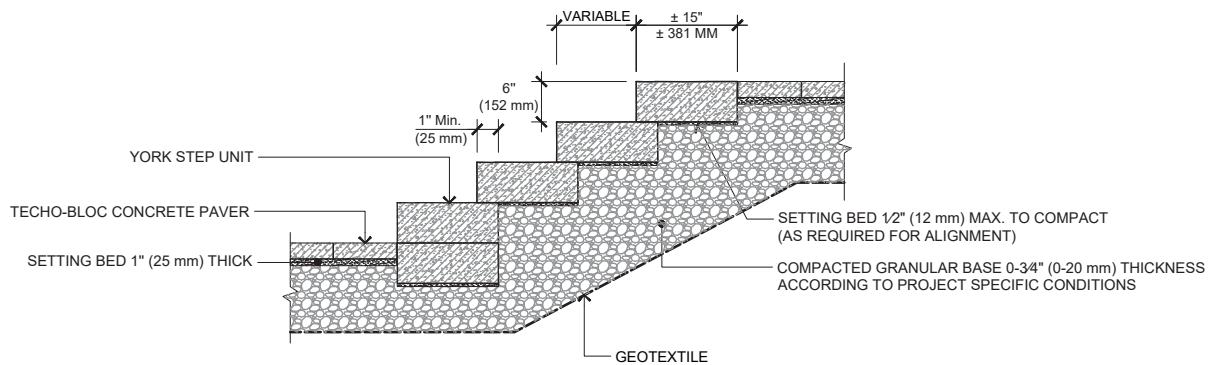



## BOREALIS

DESCRIPTION: Step TEXTURE: Wood

### Pallet Overview

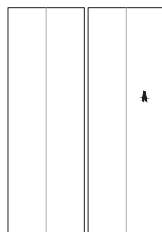

### Specifications per pallet



8 units / pallet

	Imperial	Metric
Dimension Front (L×D×H)	48 × 15 ¾ × 6	1 219 × 400 × 152
Dimension Back (L×D×H)	48 × 16 × 6	1 219 × 406 × 152
Cubing	32 lin. ft	9.76 lin. m
Approx. Weight	3 073 lbs	1 394 kg
Number of rows	4	
Coverage per row	8 lin. ft	2.44 lin. m
Lin. coverage per row	4 lin. ft	1.22 lin. m

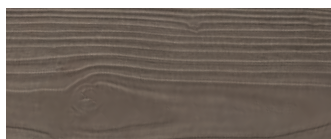

Wood  
Smoked Pine

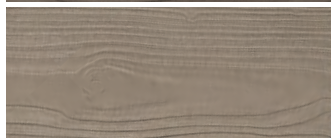

Wood  
Hazelnut Brandy

### NOTES

See page 6 for icons description.

\*For an authentic look, each color option is composed of a variety of darker & lighter tones. Natural ingredients such as granite are present within the recipe to allow for a range in tones, veining and textures from one stone to another.

To achieve a natural appearance, product dimensions can vary ± 3/16" (5 mm) for height and ± 1/2" (13 mm) for length and width.

Please note that for barefoot walking areas (e.g. pool deck) dark-colored paving units could get very hot under the sun.



# MAYA

DESCRIPTION: Step TEXTURE: Slate

Specifications per pallet	Imperial	Metric
 Product dimension (L×D×H)	48 × 32 × 6	1 219 × 813 × 152
Cubing	4 units	4 units
4 units / pallet	Approx. Weight	2 550 lbs / 1 157 kg
Number of rows	4	
Coverage (Approx.)	16 lin. ft	4.88 lin. m.
Linear coverage per row (Approx.)	4 lin. ft	1.22 lin. m.

## Pallet Overview

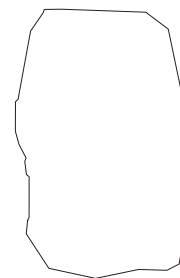

## MAYA STEP PATTERNS (EXAMPLES)

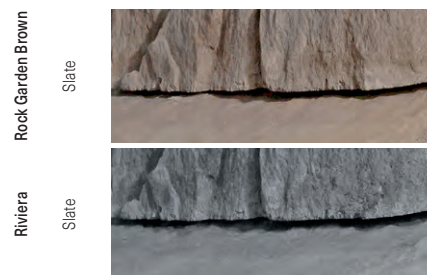
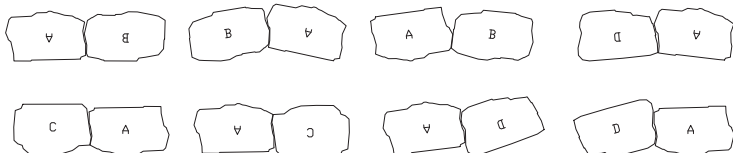

## NOTES

See page 6 for icons description.

\*For an authentic look, each color option is composed of a variety of darker & lighter tones. Natural ingredients such as granite are present within the recipe to allow for a range in tones, veining and textures from one stone to another.

To achieve a natural appearance, product dimensions can vary  $\pm \frac{3}{16}$ " (5 mm) for height and  $\pm \frac{1}{2}$ " (13 mm) for length and width.

Manufactured in four different shapes that may result in an uneven distribution in the packaging. As a result, it is not guaranteed that a pallet will contain all the 4 units in different shapes.

Please note that for barefoot walking areas (e.g. pool deck) dark-colored paving units could get very hot under the sun.



D ❄️

# RAFFINATO

DESCRIPTION: Step TEXTURE: Smooth

## Pallet Overview

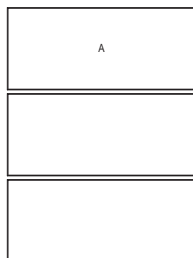

## Specifications per pallet



9 units / pallet

	Imperial	Metric
Product dimension (L x D x H)	42 x 14 1/2 x 7 1/8	1 067 x 368 x 180
Cubing	9 units	9 units
Approx. Weight	3 236 lbs	1 468 kg
Number of rows	3	
Coverage per row	10.5 lin. ft	3.2 lin. m
Lin. coverage per row	31.5 lin. ft	9.6 lin. m



Smooth

Caffè Crema



Smooth

Beige Cream

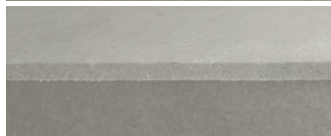

Smooth

Greyed Nickel

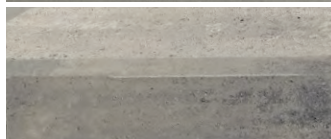

Smooth

Shale Grey

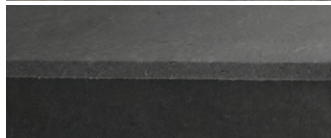

Smooth

Onyx Black

## NOTES

See page 6 for icons description.

Please note that for barefoot walking areas (e.g. pool deck) dark-colored paving units could get very hot under the sun.



# RÖCKA

DESCRIPTION: Step TEXTURE: Fossil stone

## 48" DOUBLE-SIDED

Specifications per pallet		Imperial	Metric
	Dimension Front (L x D x H)	48 x 14 7/8 x 6	1 219 x 378 x 152
	Dimension Back (L x D x H)	48 x 14 1/8 x 6	1 219 x 359 x 152
8 units / pallet	Cubing	8 units	8 units
	Linear coverage per pallet	32 lin. ft	9.76 lin. m
	Approx. Weight	2 770 lbs	1 256 kg
	Number of rows	4	
	Lin. coverage per row	8 lin. ft	2.44 lin. m

## 60"

Specifications per pallet		Imperial	Metric
	Dimension Front (L x D x H)	60 x 15 1/4 x 6	1 524 x 387 x 152
	Dimension Back (L x D x H)	60 x 14 5/8 x 6	1 524 x 371 x 152
6 units / pallet	Cubing	6 units	6 units
	Linear coverage per pallet	30 lin. ft	9.14 lin. m
	Approx. Weight	2 640 lbs	1 197 kg
	Number of rows	2	
	Lin. coverage per row	15 lin. ft	4.57 lin. m

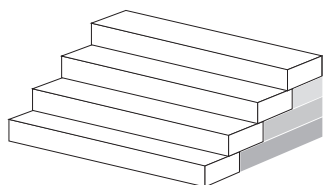

# RÖCKA

## WALL & EDGE

When building a staircase, the Röcka wall can be used to complete the sides and act as part of a structural system. See the product specifications on page 250.

## Pallet Overview - 48"

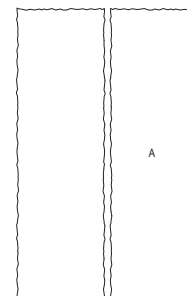

## Pallet Overview - 60"

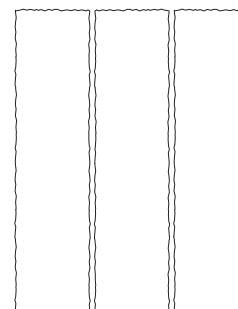

Chocolate Brown  
Rock Garden Brown  
Riviera

Fossil stone  
Fossil stone  
Fossil stone

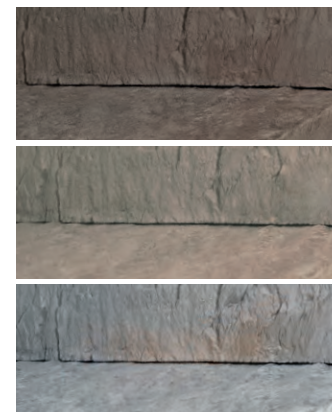

## NOTES

See page 6 for icons description.

Röcka 48" is a double-sided step. Each side has slight natural texture differences. Please take that into consideration when installing them side by side. We recommend keeping the same texture together.

Please note that there is a slight vertical angle on the front and back faces of the step 3/8", from the bottom to the top of the step.

To achieve a natural appearance, product dimensions can vary  $\pm 3/16"$  (5 mm) for height and  $\pm 1/2"$  (13 mm) for length and width.

\*For an authentic look, each color option is composed of a variety of darker & lighter tones. Natural ingredients such as granite are present within the recipe to allow for a range in tones, veining and textures from one stone to another.

Please note that for barefoot walking areas (e.g. pool deck) dark-colored paving units could get very hot under the sun.

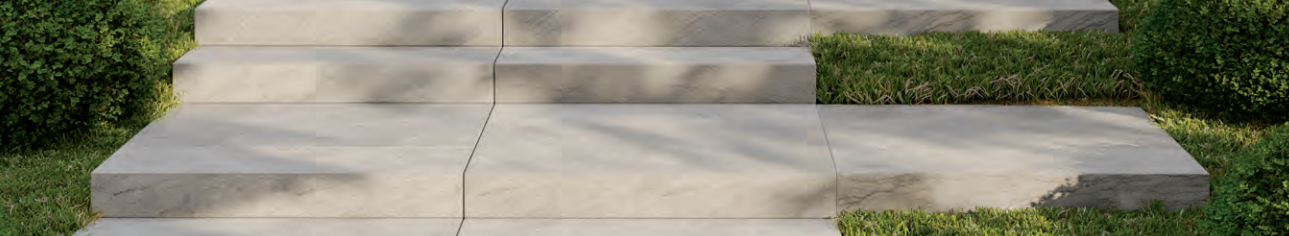

## SANDSTONE Natural Stone collection

DESCRIPTION: Step TEXTURE: Natural stone

### Pallet Overview

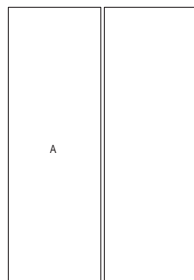

### Specifications per pallet



4 units / pallet

	Imperial	Metric
Product dimension (L x D x H)	47 1/4 x 15 3/4 x 5 7/8	1 200 x 400 x 150
Linear coverage per pallet	15.75 lin. ft	4.80 lin. m
Approx. Weight	1 742 lbs	790 kg
Number of rows	2	
Linear coverage per row	7.87 lin. ft	2.40 lin. m.



Natural stone  
Grey

Natural stone  
Beige

### NOTES

See page 6 for icons description.

#### NATURAL STONE COLLECTION

Natural stones are products of nature. They are sold as is and are not covered by Techo-Bloc's Warranty. Installation is deemed acceptance of products.

Please note that for barefoot walking areas (e.g. pool deck) dark-colored paving units could get very hot under the sun.

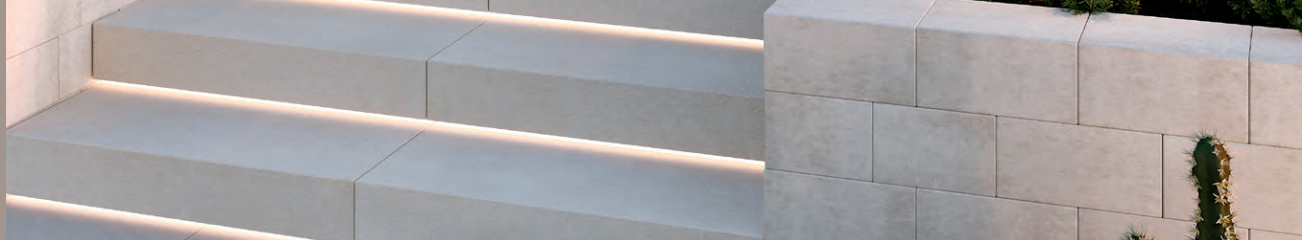

# SYSTEMA (Available Spring 2026)

**DESCRIPTION:** Lighting Ready Step\* **TEXTURE:** Smooth

Specifications per pallet	Imperial	Metric	
 8 units / pallet	Product dimension (L×D×H)	42 × 16 ¾ × 7 ¼	1 067 × 425 × 180
	Cubing	28 lin.ft	8.54 lin.m.
Approx. Weight	3 270 lbs	1 483 kg	
Number of rows	2		
Linear coverage per unit (Approx.)	3.5 lin.ft	1.07 lin.m.	

## Pallet Overview\*\*

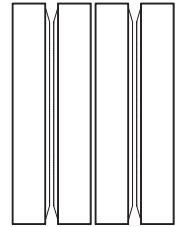

## NOTES

See page 6 for icons description.

\*Designed for easy integration of lighting with a 19 mm height recessed channel under the step.

\*\*Palletized upright.

Please note that for barefoot walking areas (e.g. pool deck) dark-colored paving units could get very hot under the sun.



# TERRAZZO

DESCRIPTION: Step TEXTURE: Polished

## Pallet Overview

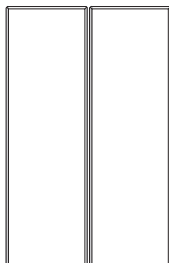

## Specifications per pallet



8 units / pallet

	Imperial	Metric
Product dimension (L x D x H)	48 x 15 x 6	1 219 x 381 x 152
Cubing	32 lin. ft	9.76 lin. m.
Approx. Weight	2 840 lbs	1 288 kg
Number of rows	4	
Lin. coverage per unit	4 lin.ft	1.22 lin.m.

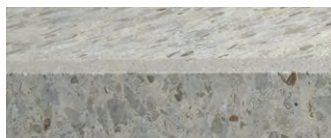

Polished  
Stardust Beige



Polished  
Mineral White

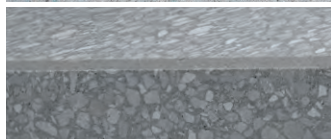

Polished  
Moonrock Grey

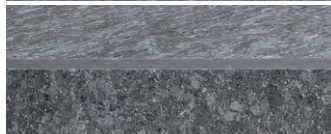

Polished  
Meteor Black

## NOTES

See page 6 for icons description.

Every unit is calibrated to ensure height is within a 1 mm tolerance.

\*The Terrazzo Collection comes with a factory-applied, water-based "natural look" protectant that enhances the surface and aids in maintenance. However, to maintain its de-icing salt resistant properties, it is essential to re-apply a concrete or natural stone water-based protectant or sealer periodically.

We recommend applying the protectant as soon as you observe water absorption. If water is still repelled, re-application is not yet necessary. Always test the protectant or sealer on a small, hidden area before full application.

Please note that for barefoot walking areas (e.g. pool deck) dark-colored paving units could get very hot under the sun.



## YORK 60"

**DESCRIPTION:** Step **TEXTURE:** Limestone surface with chiseled edges

Specifications per pallet	Imperial	Metric
 Product dimension (L×D×H)	60 × 15 × 6	1 524 × 381 × 152
Cubing	6 units	6 units
6 units / pallet	Linear coverage per pallet	30 lin. ft / 9.14 lin. m
	Approx. Weight	2 649 lbs / 1 202 kg
	Number of rows	2
	Linear coverage per row	15 lin. ft / 4.57 lin. m

### Pallet Overview

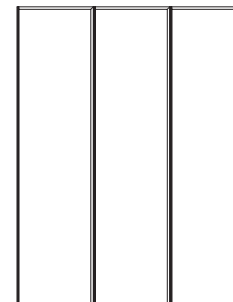

Rock Garden Brown

Limestone surface  
with chiseled edges



Riviera

Limestone surface  
with chiseled edges

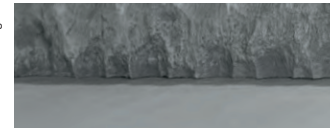

### NOTES

See page 6 for icons description.

York is a single sided step chiseled on 3 sides.

\*For an authentic look, each color option is composed of a variety of darker & lighter tones. Natural ingredients such as granite are present within the recipe to allow for a range in tones, veining and textures from one stone to another.

To achieve a natural appearance, product dimensions can vary  $\pm \frac{3}{16}$ " (5 mm) for height and  $\pm \frac{1}{2}$ " (13 mm) for length and width.

Please note that for barefoot walking areas (e.g. pool deck) dark-colored paving units could get very hot under the sun.



## BLU 45 mm

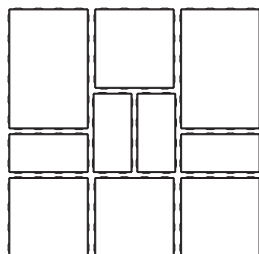

**DESCRIPTION:** Concrete Overlay System **TEXTURE:** Slate

### Pallet Overview



Slate  
Chestnut Brown  
Slate  
Champlain Grey  
Slate  
Shale Grey

### Specifications per pallet

		Imperial	Metric
<b>A</b> 	Product dimension (L x D x H) <b>A</b>	6 1/2 x 13 x 1 3/4	165 x 330 x 45
	Product dimension (L x D x H) <b>B</b>	13 x 13 x 1 3/4	330 x 330 x 45
48 units / pallet	Product dimension (L x D x H) <b>C</b>	19 1/2 x 13 x 1 3/4	495 x 330 x 45
<b>B</b> 	Cubing	127.44 ft <sup>2</sup>	11.84 m <sup>2</sup>
	Approx. Weight	2 631 lbs	1 193 kg
<b>C</b> 	Number of rows	12	
	Coverage per row	10.62 ft <sup>2</sup>	0.99 m <sup>2</sup>
24 units / pallet			

### Laying Patterns Options

01 | Linear

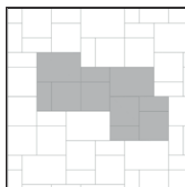

02 | Linear

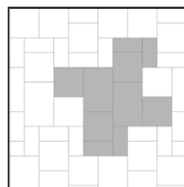

03 | Modular

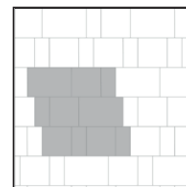

Patterns are for design inspiration only. The installer is responsible to calculate & purchase the correct amount of material.

### NOTES

See page 6 for icons description.

Blu 45 mm should only be used to overlay existing concrete patios.

**Techo-Bloc always recommends gluing the caps with concrete adhesive to ensure stability and safety.**

See page 248 for more technical information.



For joint filling surface coverage, see page 36.

Please note that for barefoot walking areas (e.g. pool deck) dark-colored paving units could get very hot under the sun.



## BLU 45 mm

**DESCRIPTION:** Concrete Overlay System **TEXTURE:** Smooth

Specifications per pallet		Imperial	Metric
<b>A</b>		Product dimension (L×D×H) <b>A</b> 6 ½ × 13 × 1 ¾	165 × 330 × 45
		Product dimension (L×D×H) <b>B</b> 13 × 13 × 1 ¾	330 × 330 × 45
		Product dimension (L×D×H) <b>C</b> 19 ½ × 13 × 1 ¾	495 × 330 × 45
	48 units / pallet		
<b>B</b>		Cubing 127.44 ft <sup>2</sup>	11.84 m <sup>2</sup>
	48 units / pallet	Approx. Weight 2 631 lbs	1 193 kg
<b>C</b>		Number of rows 12	
	24 units / pallet	Coverage per row 10.62 ft <sup>2</sup>	0.99 m <sup>2</sup>

### Pallet Overview

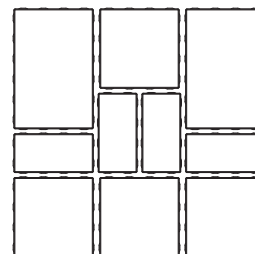

### Laying Patterns Options

01 | Linear

02 | Linear

03 | Modular

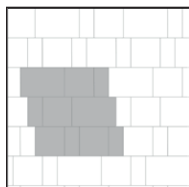
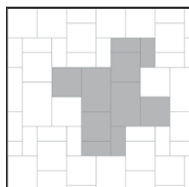
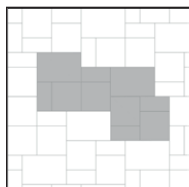

Patterns are for design inspiration only. The installer is responsible to calculate & purchase the correct amount of material.

Chestnut Brown

Smooth

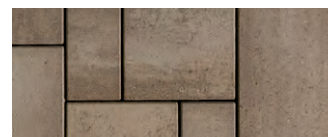

Champlain Grey

Smooth

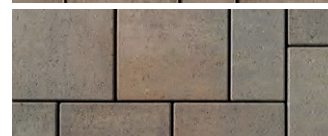

Beige Cream

Smooth

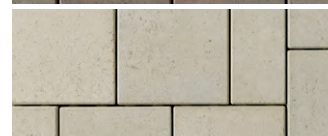

Grayed Nickel

Smooth

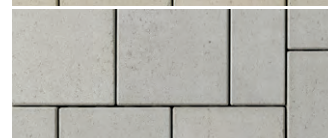

Shale Grey

Smooth

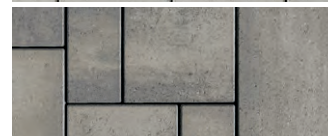

Onyx Black

Smooth

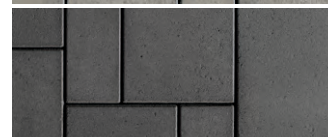

### NOTES

See page 6 for icons description.

Blu 45 mm should only be used to overlay existing concrete patios.

**Techo-Bloc always recommends gluing the caps with concrete adhesive to ensure stability and safety.**

See page 248 for more technical information.

For joint filling surface coverage, see page 36.

Please note that for barefoot walking areas (e.g. pool deck) dark-colored paving units could get very hot under the sun.



# SANDSTONE

**DESCRIPTION:** Natural Stone Cap Overlay System    **TEXTURE:** Natural Stone

## Pallet Overview

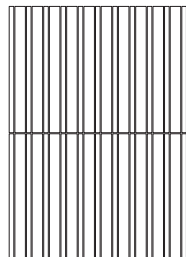

Natural Stone  
**Beige**

Natural Stone  
**Grey**

## Specifications per pallet



84 units / pallet

	Imperial	Metric
Dimension (L x D x H x H)	23 5/8 x 12 x 7/8 x 1 15/16	600 x 305 x 22 x 50
Cubing	165.35 lin. ft	50.4 lin. m
Approx. Weight	2 017 lbs	915 kg
Number of rows	2	
Linear coverage per row	82.68 lin. ft	25.2 lin. m

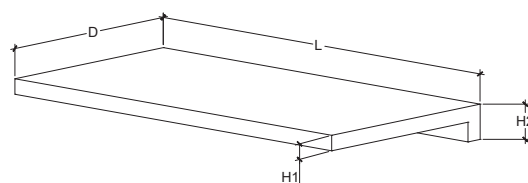

## NOTES

See page 6 for icons description.

Palletized upright.

### NATURAL STONE COLLECTION

Natural stones are products of nature. They are sold as is and are not covered by Techo-Bloc's Warranty. Installation is deemed acceptance of products.

Please note that for barefoot walking areas (e.g. pool deck) dark-colored paving units could get very hot under the sun.



# VENETIAN

DESCRIPTION: Step Overlay System    TEXTURE: Slate

## RISER

Specifications per pallet		Imperial	Metric
 48 units / pallet	Product dimension (L x D x H)	16 x 7 x 1 3/4	406 x 178 x 45
	Cubing	48 units	48 units
	Linear coverage per pallet	64 lin. ft	19.52 lin. m
	Approx. Weight	801 lbs	363 kg
	Units	1.33 lin. ft	0.41 lin. m
	Number of rows	4	
	Lin. coverage per row	16 lin. ft	4.88 lin. m

## Pallet Overview - Riser

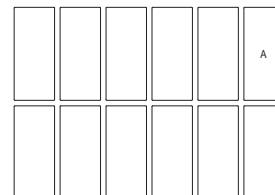

## CAP

Specifications per pallet		Imperial	Metric
 48 units / pallet	Product dimension (L x D x H)	16 x 14 x 1 3/4	406 x 356 x 45
	Cubing	48 units	48 units
	Linear coverage per pallet	64 lin. ft	19.52 lin. m
	Approx. Weight	1 530 lbs	694 kg
	Units	1.33 lin. ft	0.41 lin. m
	Number of rows	8	
	Lin. coverage per row	8 lin. ft	2.44 lin. m

## Pallet Overview - Cap



Chestnut Brown  
Champlain Grey  
Shale Grey

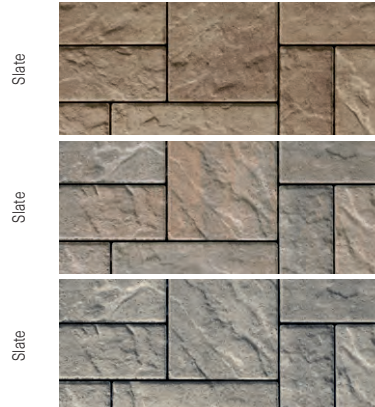

## NOTES

See page 6 for icons description.

**Techo-Bloc always recommends gluing the caps with concrete adhesive to ensure stability and safety.**

See page 248 for product compatibility.

Please note that for barefoot walking areas (e.g. pool deck) dark-colored paving units could get very hot under the sun.



# VENETIAN

**DESCRIPTION:** Step Overlay System **TEXTURE:** Smooth

## Pallet Overview - Riser

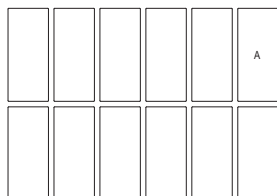

## Pallet Overview - Cap



### RISER

#### Specifications per pallet



48 units / pallet

	Imperial	Metric
Product dimension (L x D x H)	15 5/8 x 7 x 1 3/4	397 x 178 x 45
Cubing	48 units	48 units
Linear coverage per pallet	62.52 lin. ft	19.06 lin. m
Approx. Weight	811 lbs	368 kg
Units	1.30 lin. ft	0.40 lin. m
Number of rows	4	
Lin. coverage per row	15.63 lin. ft	4.76 lin. m

### CAP

#### Specifications per pallet



48 units / pallet

	Imperial	Metric
Product dimension (L x D x H)	15 5/8 x 14 x 1 3/4	397 x 356 x 45
Cubing	48 units	48 units
Linear coverage per pallet	62.52 lin. ft	19.06 lin. m
Approx. Weight	1 500 lbs	680 kg
Units	1.30 lin. ft	0.40 lin. m
Number of rows	8	
Lin. coverage per row	7.81 lin. ft	2.38 lin. m



Smooth Chestnut Brown  
Smooth Champlain Grey  
Smooth Beige Cream  
Smooth Greyed Nickel  
Smooth Shale Grey

## NOTES

See page 6 for icons description.

**Techo-Bloc always recommends gluing the caps with concrete adhesive to ensure stability and safety.**

See page 248 for product compatibility.



Please note that for barefoot walking areas (e.g. pool deck) dark-colored paving units could get very hot under the sun.



D ❄️

# ARCHITECTURAL

DESCRIPTION: Cap Double-Sided TEXTURE: Split Face

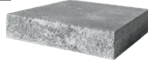
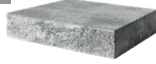
Specifications per pallet		Imperial	Metric
<b>A</b> 	Dimension Front (L x D x H) <b>A</b>	8 7/8 x 12 1/2 x 2 15/16	225 x 317 x 75
	Dimension Back (L x D x H) <b>A</b>	6 1/2 x 12 1/2 x 2 15/16	165 x 317 x 75
24 units / pallet	Dimension Front (L x D x H) <b>B</b>	11 13/16 x 12 1/2 x 2 15/16	300 x 317 x 75
<b>B</b> 	Dimension Back (L x D x H) <b>B</b>	9 7/16 x 12 1/2 x 2 15/16	240 x 317 x 75
	Dimension Front (L x D x H) <b>C</b>	14 3/4 x 12 1/2 x 2 15/16	375 x 317 x 75
24 units / pallet	Dimension Back (L x D x H) <b>C</b>	12 9/16 x 12 1/2 x 2 15/16	315 x 317 x 75
<b>C</b> 	Dimension Front (L x D x H) <b>C*</b>	14 3/4 x 12 1/2 x 2 15/16	375 x 317 x 75
	Dimension Back (L x D x H) <b>C*</b>	13 9/16 x 12 1/2 x 2 15/16	345 x 317 x 75
8 units / pallet	Cubing	66 lin. ft	20.12 lin. m
<b>C*</b> 	Approx. Weight	2 390 lbs	1 084 kg
	Number of rows	8	
	Lin. coverage per row	8.25 lin. ft	2.51 lin. m

## Pallet Overview

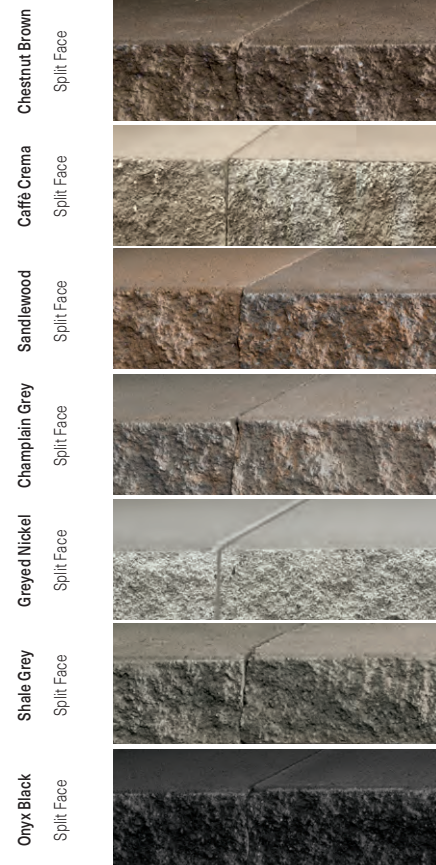
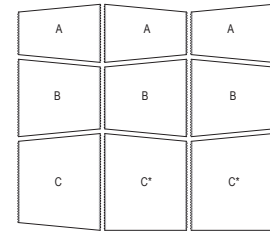

## NOTES

See page 6 for icons description.

See page 246 for product compatibility.

The **C\*** unit can be used as left and right corner units. It can also be used as a regular unit.

**Techo-Bloc always recommends gluing the caps with concrete adhesive to ensure stability and safety.**

Please note that for barefoot walking areas (e.g. pool deck) dark-colored paving units could get very hot under the sun.

# INSTALLATION GUIDE

## CAP RADIUS - ARCHITECTURAL

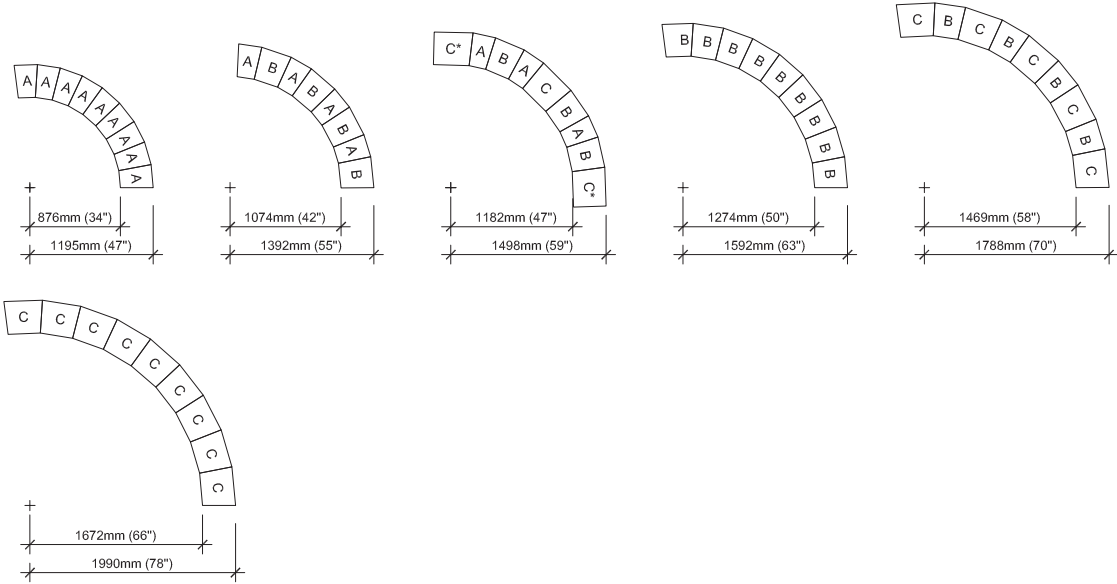

It is the user's responsibility to verify for the quantity of materials required.



## BALI TRAVERTINA RAW

**DESCRIPTION:** Bullnose Pool coping **TEXTURE:** Klean-Bloc Brushed Travertine

### Specifications per pallet



28 units / pallet

	Imperial	Metric
Dimension Front (L x D x H)	16 x 12 x 2 1/4	406 x 305 x 57
Dimension Back (L x D x H)	16 x 12 x 2 3/4	406 x 305 x 70
Cubing	28 units	28 units
Linear coverage per pallet	37.33 lin. ft	11.38 lin. m
Approx. Weight	1 069 lbs	485 kg
Number of rows	1	
Linear coverage per row	37.33 lin. ft	11.38 lin. m

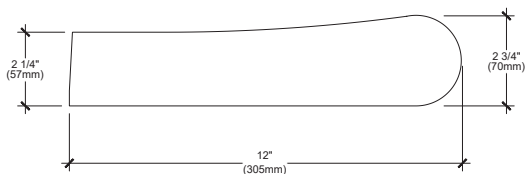

### Pallet Overview

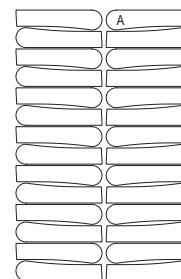

Rock Garden Brown

Klean-Bloc  
Brushed Travertine



Ivory

Klean-Bloc  
Brushed Travertine



Riviera

Klean-Bloc  
Brushed Travertine

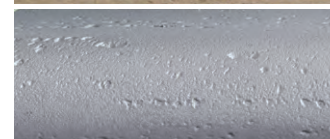

### NOTES

See page 6 for icons description.

Palletized upright.

**Techo-Bloc always recommends gluing the caps with concrete adhesive to ensure stability and safety.**

\*For an authentic look, each color option is composed of a variety of darker & lighter tones. Natural ingredients such as granite are present within the recipe to allow for a range in tones, veining and textures from one stone to another.

See 247 for more technical information.

Please note that for barefoot walking areas (e.g. pool deck) dark-colored paving units could get very hot under the sun.

D ❄️

# BRANDON

DESCRIPTION: Cap TEXTURE: Slate

## Pallet Overview

## Specifications per pallet

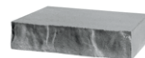

18 units / pallet

	Imperial	Metric
Product dimension (L x W x H)	16 x 14 x 3 5/16	406 x 356 x 90
Cubing	24 lin. ft	7.32 lin. m
Approx. Weight	1 213 lbs	550 kg
Linear coverage per row	24 lin. ft	7.32 lin. m
	1 lin. ft = .75 units	1 lin. m = 2.46 units



Slate  
Chestnut Brown



Slate  
Champlain Grey



Slate  
Caffè Crema

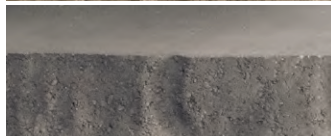

Slate  
Shale Grey



Slate  
Onyx Black

## NOTES

See page 6 for icons description.

### COMPATIBLE WALLS

See page 246 for product compatibility.

Please note that for barefoot walking areas (e.g. pool deck) dark-colored paving units could get very hot under the sun.



# LIMESTONE Natural Stone collection

DESCRIPTION: Cap TEXTURE: Natural stone

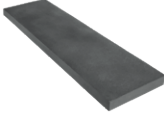
Specifications per pallet	Imperial	Metric	
 20 units / pallet	Product dimension (L x D x H)	47 1/4 x 13 3/4 x 1 15/16	1 200 x 350 x 50
	Cubing	79 lin. ft	24 lin. m
	Approx. Weight	2 601 lbs	1 180 kg
	Number of rows	10	
	Coverage per row	7.9 lin. ft	2.4 lin. m

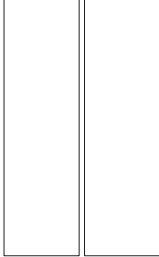
Pallet Overview

Onyx Black  
Natural stone

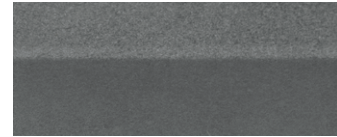

## NOTES

See page 6 for icons description.

### NATURAL STONE COLLECTION

Natural stones are products of nature. They are sold as is and are not covered by Techo-Bloc's Warranty. Installation is deemed acceptance of products.

Please note that for barefoot walking areas (e.g. pool deck) dark-colored paving units could get very hot under the sun.



# SANDSTONE & SANDSTONE BULLNOSE

DESCRIPTION: Cap TEXTURE: Natural stone

## Pallet Overview

### Sandstone & Sandstone Bullnose 14 × 48

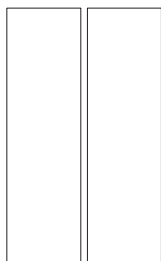

## Pallet Overview

### Sandstone Bullnose 16 × 48

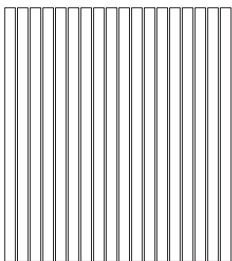

## Pallet Overview

### Sandstone Rockface

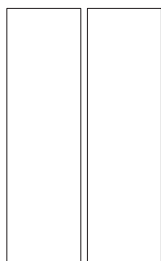

## SANDSTONE AND SANDSTONE BULLNOSE 14 × 48

### Specifications per pallet

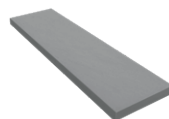

20 units / pallet

	Imperial	Metric
Product dimension (L × D × H)	47 ¼ × 13 ¾ × 1 15/16	1 200 × 350 × 50
Cubing	79 lin. ft	24 lin. m
Approx. Weight	2 601 lbs	1 180 kg
Number of rows	10	
Coverage per row	7.9 lin. ft	2.4 lin. m

## SANDSTONE BULLNOSE 16 × 48

### Specifications per pallet

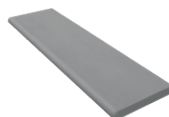

18 units / pallet

	Imperial	Metric
Product dimension (L × D × H)	47 ¼ × 15 ¾ × 1 15/16	1 200 × 400 × 50
Cubing	70.87 lin. ft	21.60 lin. m
Approx. Weight	2 597 lbs	1 178 kg
Number of rows	1	
Coverage per row	70.87 lin. ft	21.60 lin. m

## SANDSTONE ROCKFACE

### Specifications per pallet

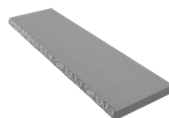

18 units / pallet

	Imperial	Metric
Product dimension (L × D × H)	47 ¼ × 13 ¾ × 1 15/16	1 200 × 350 × 50
Cubing	70.87 lin. ft	21.60 lin. m
Approx. Weight	2 271 lbs	1 030 kg
Number of rows	9	
Coverage per row	7.87 lin. ft	2.40 lin. m



## NOTES

See page 6 for icons description.

### NATURAL STONE COLLECTION

Natural stones are products of nature. They are sold as is and are not covered by Techo-Bloc's Warranty. Installation is deemed acceptance of products.

\*Sandstone Bullnose 16 × 48 only available in Grey

Please note that for barefoot walking areas (e.g. pool deck) dark-colored paving units could get very hot under the sun.



D ❄️

# BULLNOSE

**DESCRIPTION:** Cap and pool coping **TEXTURE:** Smooth

## Specifications per pallet



180 units / pallet

	Imperial	Metric
Product dimension (L×D×H)	5 7/8 × 12 × 2 3/8	150 × 305 × 60
Cubing	180 units	180 units
Linear coverage per pallet	88.60 lin. ft	27 lin. m
Units	2 units/lin. ft	6.56 units/lin. m
Approx. Weight	2 435 lbs	1 104 kg
Number of rows	4	
Linear coverage per row	22.15 lin. ft	6.75 lin. m
	1 lin. ft = 2.03 units	1 lin. m = 6.67 units

## Pallet Overview

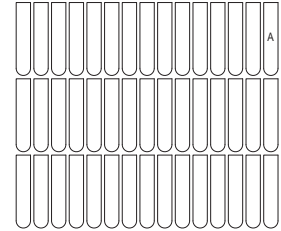

Chocolate Brown

Smooth



Chestnut Brown

Smooth



Champlain Grey

Smooth



Shale Grey

Smooth



Onyx Black

Smooth



## NOTES

See page 6 for icons description.

### COMPATIBLE WALLS

See page 246 for product compatibility.

**Techo-Bloc always recommends gluing the caps with concrete adhesive to ensure stability and safety.**

See 247 for more technical information.

Please note that for barefoot walking areas (e.g. pool deck) dark-colored paving units could get very hot under the sun.



D ❄️

## BULLNOSE GRANDE

DESCRIPTION: Cap and pool coping TEXTURE: Polished

### Pallet Overview

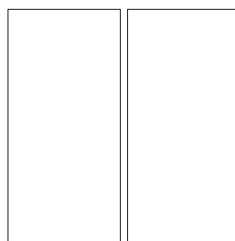

### Specifications per pallet



12 units / pallet

	Imperial	Metric
Product dimension (L x D x H)	29 1/2 x 13 13/16 x 2 3/16	750 x 351 x 55
Cubing	12 units	12 units
Linear coverage per pallet	29.53 lin. ft	9 lin. m
Approx. Weight	940 lbs	426 kg
Number of rows	6	
Linear coverage per row	4.92 lin. ft	1.50 lin. m



Polished  
Beige Cream



Polished  
Greyed Nickel

### NOTES

See page 6 for icons description.

#### COMPATIBLE WALLS

See page 246 for product compatibility.

**Techo-Bloc always recommends gluing the caps with concrete adhesive to ensure stability and safety.**



See 247 for more technical information.

Please note that for barefoot walking areas (e.g. pool deck) dark-colored paving units could get very hot under the sun.



# GRAPHIX

**DESCRIPTION:** Reversible Cap **TEXTURE:** Split Face and Smooth

Specifications per pallet		Imperial	Metric
28 units / pallet	Product dimension (L×D×H)	20 × 14 × 2 15/16	508 × 355 × 75
 split face side	Cubing	28 units	28 units
	Units	46.67 lin. ft	14.22 lin. m
 smooth side	Approx. Weight	0.60 unit/lin. ft	1.97 unit/lin. m
	Number of rows	1 950 lb	885 kg
	Lin. coverage per row	6.67 lin. ft	2.03 lin. m
		1 lin. ft = 0.60 unit	1.96 lin. m/unit

## Pallet Overview

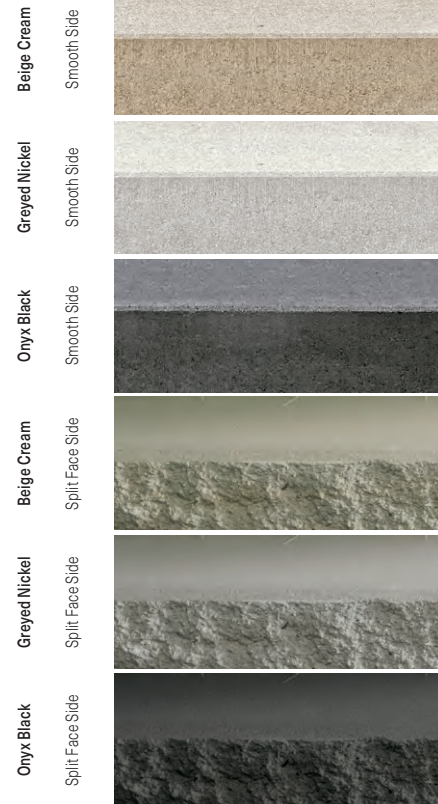
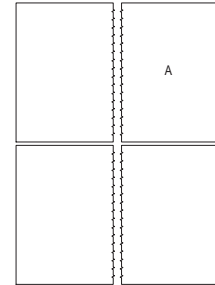

## NOTES

See page 6 for icons description.

### COMPATIBLE WALLS

See page 246 for product compatibility..

**Techo-Bloc always recommends gluing the caps with concrete adhesive to ensure stability and safety.**

Please note that for barefoot walking areas (e.g. pool deck) dark-colored paving units could get very hot under the sun.



# PIEDIMONTE

**DESCRIPTION:** Cap double-sided **TEXTURE:** Klean-Bloc Thermal

## Pallet Overview - 14" x 30"

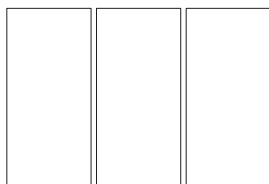

## Pallet Side View - 28" x 28"

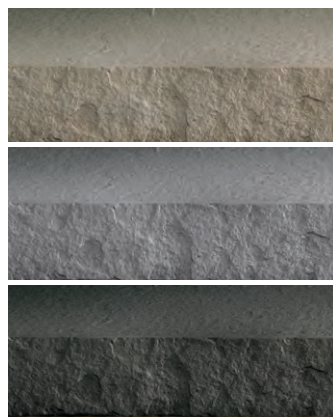
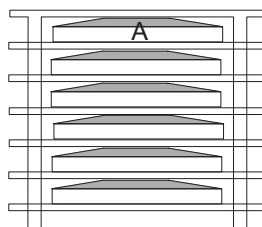

Klean-Bloc Thermal Klean-Bloc Thermal Klean-Bloc Thermal

Rock Garden Brown Riviera Onyx Black

## 14" x 30" WALL & STEP CAP

### Specifications per pallet



24 units / pallet

	Imperial	Metric
Product dimension (L x D x H)	30 x 14 x 2 1/4	762 x 356 x 57
Cubing	60 lin. ft	18.29 lin. m
Approx. Weight	1 840 lbs	835 kg
Number of rows	8	
Coverage per row	7.5 lin. ft	2.29 lin. m

## 28" x 28" PILLAR CAP

### Specifications per pallet



6 units / pallet

	Imperial	Metric
Product dimension (L x D x H)	28 x 28 x 2 7/8	711 x 711 x 73
Cubing	6 units	6 units
Approx. Weight	1 434 lbs	650 kg
Number of rows	6	

## NOTES

See page 6 for icons description.

### COMPATIBLE WALLS

See page 246 for product compatibility.

**Techo-Bloc always recommends gluing the caps with concrete adhesive to ensure stability and safety.**

**To achieve a natural appearance, stone dimension can vary up to 1/4". Metric measures are approximate.**





\*For an authentic look, each color option is composed of a variety of darker & lighter tones. Natural ingredients such as granite are present within the recipe to allow for a range in tones, veining and textures from one stone to another.

Please note that for barefoot walking areas (e.g. pool deck) dark-colored paving units could get very hot under the sun.



# PORTOFINO

DESCRIPTION: Cap double-sided TEXTURE: Fossil stone

Specifications per pallet		Imperial	Metric
<b>A</b> 	Dimension Front (L x D x H) <b>A</b>	11 3/4 x 14 1/2 x 2 1/4	298 x 368 x 57
	Dimension Back (L x D x H) <b>A</b>	9 5/8 x 14 1/2 x 2 1/4	238 x 368 x 57
14 units / pallet	Dimension Front (L x D x H) <b>B</b>	15 7/8 x 14 1/2 x 2 1/4	403 x 368 x 57
<b>B</b> 	Dimension Back (L x D x H) <b>B</b>	13 3/4 x 14 1/2 x 2 1/4	349 x 368 x 57
	Dimension Front (L x D x H) <b>C</b>	18 13/16 x 14 1/2 x 2 1/4	478 x 368 x 57
14 units / pallet	Dimension Back (L x D x H) <b>C</b>	16 1/2 x 14 1/2 x 2 1/4	419 x 368 x 57
<b>C</b> 	Dimension Front (L x D x H) <b>D</b>	19 x 14 1/2 x 2 1/4	483 x 368 x 57
	Dimension Back (L x D x H) <b>D</b>	19 x 14 1/2 x 2 1/4	483 x 368 x 57
7 units / pallet	Cubing	50.22 lin. ft	15.30 lin. m
<b>D</b> 	Approx. Weight	1 712 lbs	777 kg
	Number of rows	7	
7 units / pallet	Lin. coverage per row	7.17 lin. ft	2.19 lin. m

## Pallet Overview

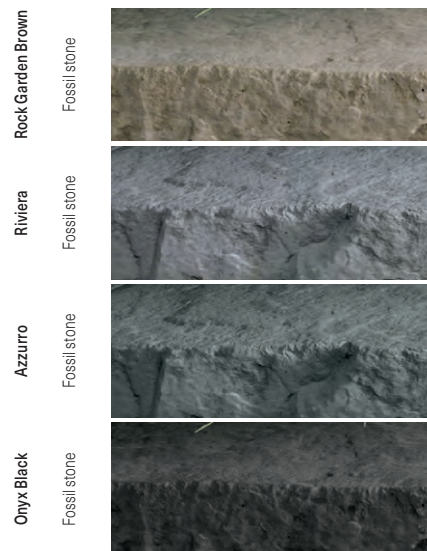
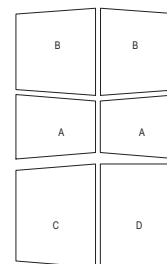

## NOTES

See page 6 for icons description.

### COMPATIBLE WALLS

See page 246 for product compatibility.

You can use the **D** cap as a left or right corner. It can also be used as a regular unit.

**Techo-Bloc always recommends gluing the caps with concrete adhesive to ensure stability and safety.**

**To achieve a natural appearance, stone dimension can vary up to 1/4". Metric measures are approximate.**

\*For an authentic look, each color option is composed of a variety of darker & lighter tones. Natural ingredients such as granite are present within the recipe to allow for a range in tones, veining and textures from one stone to another.

Please note that for barefoot walking areas (e.g. pool deck) dark-colored paving units could get very hot under the sun.

# INSTALLATION GUIDE

## CAP RADIUS - PORTOFINO

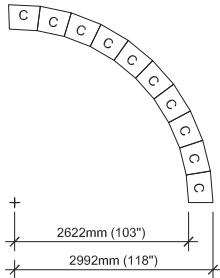
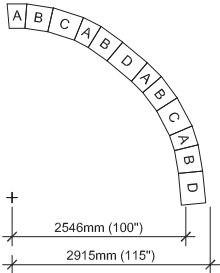
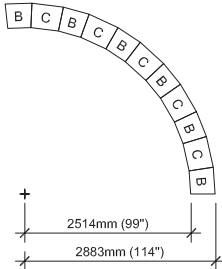
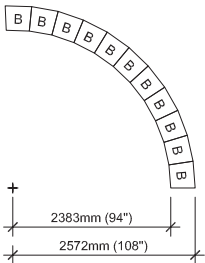
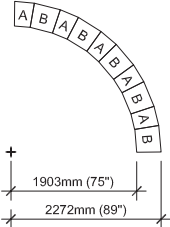
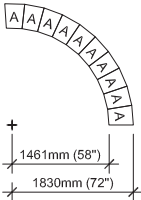



It is the user's responsibility to verify for the quantity of materials required.



## RAFFINATO 14" × 28"

DESCRIPTION: Cap double-sided TEXTURE: Smooth

90 mm		Imperial	Metric
 24 units / pallet	<b>Specifications per pallet</b>		
	Product dimension (L×D×H)	28 × 14 × 3 5/16"	711 × 356 × 90
	Cubing	24 units	24 units
	Approx. Weight	2 783 lbs	1 262 kg
	Number of rows	8	
	Linear coverage per pallet	56 lin. ft	17.07 lin. m
Linear coverage per row	7 lin. ft	2.13 lin. m	

60 mm		Imperial	Metric
 24 units / pallet	<b>Specifications per pallet</b>		
	Product dimension (L×D×H)	28 × 14 × 2 3/8"	711 × 356 × 60
	Cubing	24 units	24 units
	Approx. Weight	1 843 lbs	836 kg
	Number of rows	8	
	Linear coverage per pallet	56 lin. ft	17.07 lin. m
Linear coverage per row	7 lin. ft	2.13 lin. m	

By placing two units side by side, you will obtain a 28" pillar cap.

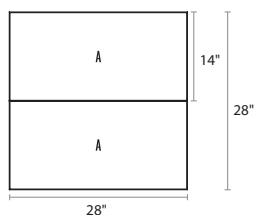

### Pallet Overview - 14" × 28"

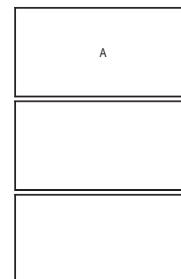

### NOTES

See page 6 for icons description.

#### COMPATIBLE WALLS

See page 246 for product compatibility.

Please note that for barefoot walking areas (e.g. pool deck) dark-colored paving units could get very hot under the sun.



# RAFFINATO 14" × 32"

DESCRIPTION: Cap double-sided TEXTURE: HD<sup>2</sup> Smooth

## Pallet Overview - 14" × 32"

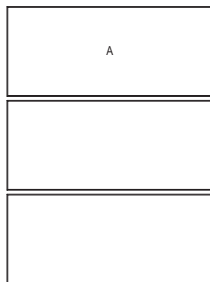

## Specifications per pallet



24 units / pallet

	Imperial	Metric
Product dimension (L × D × H)	32 × 14 × 2 3/8	812 × 356 × 60
Cubing	63.94 lin.ft	19.49 lin.m.
Approx. Weight	2 150 lbs	975 kg
Number of rows	8	
Linear coverage per row	7.99 lin.ft	2.44 lin.m.



HD<sup>2</sup> Smooth  
Chestnut Brown



HD<sup>2</sup> Smooth  
Caffè Crema



HD<sup>2</sup> Smooth  
Beige Cream



HD<sup>2</sup> Smooth  
Champlain Grey



HD<sup>2</sup> Smooth  
Greyed Nickel



HD<sup>2</sup> Smooth  
Silver Granite

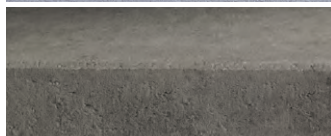

HD<sup>2</sup> Smooth  
Shale Grey

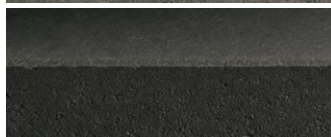

HD<sup>2</sup> Smooth  
Onyx Black

## NOTES

See page 6 for icons description.

### COMPATIBLE WALLS

See page 246 for product compatibility.

Please note that for barefoot walking areas (e.g. pool deck) dark-colored paving units could get very hot under the sun.



## TERRAZZO & TERRAZZO BULLNOSE

DESCRIPTION: Cap TEXTURE: Polished

### TERRAZZO

Specifications per pallet		Imperial	Metric
 24 units / pallet	Product dimension (L x D x H)	32 x 14 x 2 3/8	813 x 356 x 60
	Cubing	64 lin. ft	19.51 lin. m.
	Approx. Weight	2 228 lbs	1 011 kg
	Number of rows	8	
	Lin. coverage per row	8 lin.ft	2.44 lin.m.

### TERRAZZO BULLNOSE

Specifications per pallet		Imperial	Metric
 24 units / pallet	Product dimension (L x D x H)	32 x 13 13/16 x 2 3/8	813 x 351 x 60
	Cubing	64 lin. ft	19.51 lin. m.
	Approx. Weight	2 168 lbs	983 kg
	Number of rows	8	
	Lin. coverage per row	8 lin.ft	2.44 lin.m.

### Pallet Overview - Terrazzo

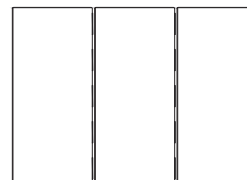

### Pallet Overview - Terrazzo Bullnose

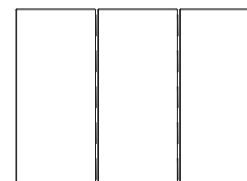

### NOTES

See page 6 for icons description.

Every unit is calibrated to ensure height is within a 1 mm tolerance.

The Terrazzo Collection comes with a factory-applied, water-based "natural look" protectant that enhances the surface and aids in maintenance. However, to maintain its de-icing salt resistant properties, it is essential to re-apply a concrete or natural stone water-based protectant or sealer periodically.

We recommend applying the protectant as soon as you observe water absorption. If water is still repelled, re-application is not yet necessary. Always test the protectant or sealer on a small, hidden area before full application.

Please note that for barefoot walking areas (e.g. pool deck) dark-colored paving units could get very hot under the sun.



## TRAVERTINA RAW

**DESCRIPTION:** Cap double-sided **TEXTURE:** Klean-Bloc Brushed Travertine

### Pallet Overview - 14" x 28"

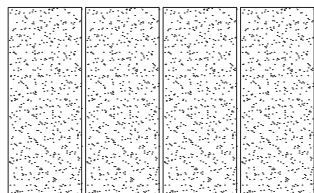

14 x 28"

#### Specifications per pallet



	Imperial	Metric
Product dimension (L x D x H)	28 x 14 x 2 1/4	711 x 356 x 57
Cubing	24 units	24 units
	56 lin. ft	17.07 m. lin
Approx. Weight	1 684 lbs	764 kg
Number of rows	8	
Linear coverage per row	7 lin. ft/row	2.13 lin. m/row

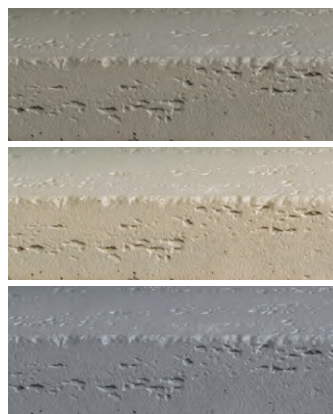

Klean-Bloc  
Brushed Travertine  
Rock Garden Brown

Klean-Bloc  
Brushed Travertine  
Ivory

Klean-Bloc  
Brushed Travertine  
Riviera

By placing two units side by side, you will obtain a 28" pillar cap.

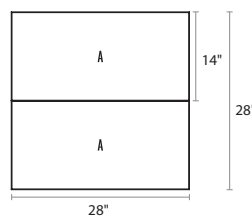

### NOTES

See page 6 for icons description.

#### COMPATIBLE WALLS

See page 246 for product compatibility.

Please note that for barefoot walking areas (e.g. pool deck) dark-colored paving units could get very hot under the sun.



## YORK Pillar Caps

**DESCRIPTION:** Cap double-sided **TEXTURE:** Klean-Bloc Brushed Limestone surface with chiseled edges

28" x 28"		Imperial	Metric
 6 units / pallet	Specifications per pallet		
	Product dimension (LxDxH)	28 ¾ x 28 ¾ x 3 ½	730 x 730 x 89
	Cubing	6 units	6 units
	Approx. Weight	1 440 lbs	653 kg
	Number of rows	6	

32" x 32"		Imperial	Metric
 6 units / pallet	Specifications per pallet		
	Product dimension (LxDxH)	32 x 32 x 3 ½	813 x 813 x 89
	Cubing	6 units	6 units
	Approx. Weight	1 727 lbs	783 kg
	Number of rows	6	

Pallet Side View - 28" and 32"

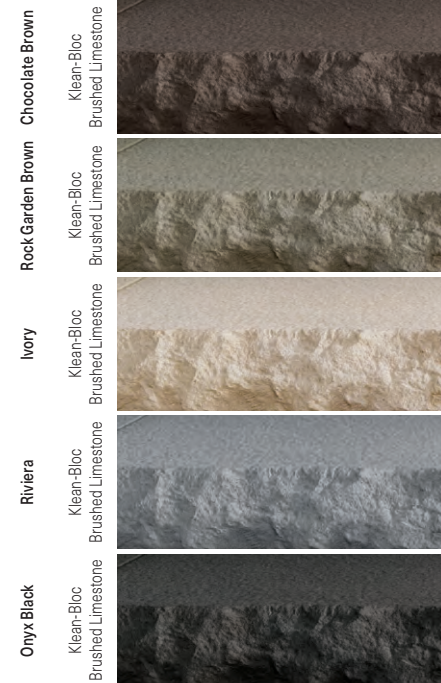
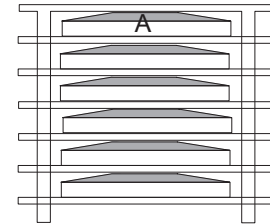

### NOTES

See page 6 for icons description.

**COMPATIBLE PILLARS - YORK 28"**

See page 246 for product compatibility.

**COMPATIBLE PILLAR - YORK 32"**

See page 246 for product compatibility.

**Techo-Bloc always recommends gluing the caps with concrete adhesive to ensure stability and safety.**

**To achieve a natural appearance, stone dimension can vary up to ¼".**

\*For an authentic look, each color option is composed of a variety of darker & lighter tones. Natural ingredients such as granite are present within the recipe to allow for a range in tones, veining and textures from one stone to another.

Please note that for barefoot walking areas (e.g. pool deck) dark-colored paving units could get very hot under the sun.



# YORK

**DESCRIPTION:** Wall caps double-sided **TEXTURE:** Klean-Bloc Brushed Limestone surface with chiseled edges

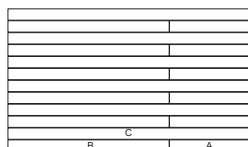

### Pallet Overview - 14" x 16", 14" x 32" & 14" x 48"

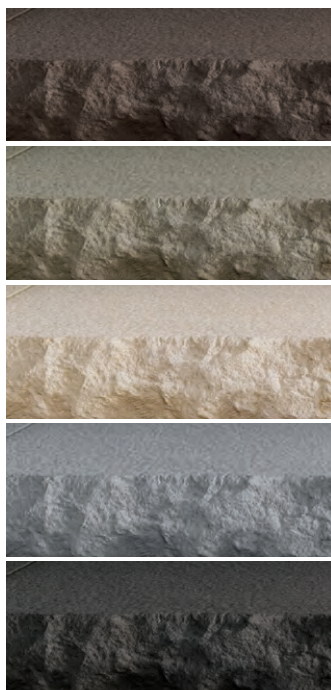
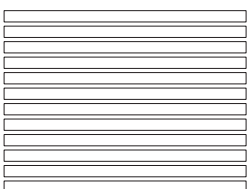

### Pallet Overview - 14" x 48"



Klean-Bloc Brushed Limestone  
Chocolate Brown  
Klean-Bloc Brushed Limestone  
Rock Garden Brown  
Klean-Bloc Brushed Limestone  
Ivory  
Klean-Bloc Brushed Limestone  
Riviera  
Klean-Bloc Brushed Limestone  
Onyx Black

14" x 16" 14" x 32" 14" x 48"		Imperial	Metric
<b>Specifications per pallet</b>			
<b>A</b>		Product dimension (L x D x H) <b>A</b> 16 x 14 x 2 1/4	406 x 356 x 57
	6 units / pallet	Product dimension (L x D x H) <b>B</b> 32 x 14 x 2 1/4	813 x 356 x 57
		Product dimension (L x D x H) <b>C</b> 48 x 14 x 2 1/4	1 219 x 356 x 57
<b>B*</b>		Cubing	48 lin. ft / 14.63 lin. m
	6 units / pallet	Approx. Weight	1 597 lbs / 724 kg
<b>C</b>		Number of rows	1
	6 units / pallet	Linear coverage per pallet	48 lin. ft / 14.63 lin. m

14"x48"		Imperial	Metric
<b>Specifications per pallet</b>			
		Product dimension (L x D x H) 48 x 14 x 2 1/4	1 219 x 356 x 57
	12 units / pallet	Cubing	48 lin. ft / 14.63 lin. m
		Approx. Weight	1 582 lbs / 718 kg
		Number of rows	1
		Linear coverage per unit	4 lin. ft / 1.22 lin. m

## NOTES

See page 6 for icons description.

### COMPATIBLE WALLS

See page 246 for product compatibility.

Palletized upright.

**Techo-Bloc always recommends gluing the caps with concrete adhesive to ensure stability and safety.**

**To achieve a natural appearance, stone dimension can vary up to 1/4".**

**Metric measures are approximate.**

**B\*** Double sided unit with finished texture at one end

\*For an authentic look, each color option is composed of a variety of darker & lighter tones. Natural ingredients such as granite are present within the recipe to allow for a range in tones, veining and textures from one stone to another.

Please note that for barefoot walking areas (e.g. pool deck) dark-colored paving units could get very hot under the sun.



## YORK 24" × 36"

**DESCRIPTION:** Counter top **TEXTURE:** Klean-Bloc Brushed Limestone surface with chiseled edges on the four sides

24" × 36"		Imperial	Metric
 16 units / pallet	<b>Specifications per pallet</b>		
	Product dimension (L×D×H)	36 × 24 × 2 ¼	914 × 610 × 57
	Cubing	16 units	16 units
	Approx. Weight	2 595 lbs	1 177 kg
	Number of rows	1	

Pallet Overview

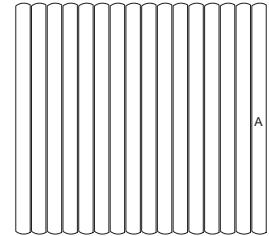

### NOTES

See page 6 for icons description.

Palletized upright.

**Techo-Bloc always recommends gluing the caps with concrete adhesive to ensure stability and safety.**

**To achieve a natural appearance, stone dimension can vary up to ¼".**

**Metric measures are approximate.**

\*For an authentic look, each color option is composed of a variety of darker & lighter tones. Natural ingredients such as granite are present within the recipe to allow for a range in tones, veining and textures from one stone to another.

Please note that for barefoot walking areas (e.g. pool deck) dark-colored paving units could get very hot under the sun.

# ACCESSORIES



Jointing Materials P. 284  
Permeable Bedding Solutions  
& Binders P. 285  
Adhesives P. 285

Edging & Base P. 286  
Cleaners P. 287  
Sealers P. 288  
Pedestals P. 291



## JOINTING MATERIALS



**FLEXLOCK - SAND - 50 LBS**

001210 - BEIGE

001211 - GREY



**FLEXLOCK - ULTRA SAND - 50 LBS**

001212 - BEIGE

001213 - GREY



**FLEXLOCK - G2 SAND - 50 LBS**

005733 - BEIGE

005734 - GREY



**FLEXLOCK - G2 ULTRA SAND - 50 LBS**

005735 - BEIGE

005736 - GREY

005737 - IVORY

005738 - ONYX BLACK



**GATOR - NITRO SAND - 40 LBS**

006013 - BEIGE

006014 - GREY

006015 - BLACK

006684 - SILVER



**GATOR - NITRO X FINE SAND - 27.5 LBS**

015011 - BLACK

015012 - GUNMETAL

015013 - TAUPE

015014 - PLATINUM



**SEK - POLY SWEEP SAND - 50 LBS**

006995 - TAN

006996 - GREY

006997 - PLATINUM

009058 - BLACK

009059 - FIELDSTONE

Exclusive to US Market



**SEK - POLY SWEEP WIDE JOINT SAND - 50 LBS**

009061 - TAN

009062 - GREY

009063 - PLATINUM

009064 - BLACK

009065 - FIELDSTONE

Exclusive to US Market



**ROMEX - ECOFINE 27.5 LBS**

009959 - STONE GREY

009960 - BEIGE

009961 - BASALT



**ROMEX - FLEXJOINT - 55 LBS**

009917 - STONE GREY

009915 - NEUTRAL

009916 - BASALT

SCAN



SCAN

DISCOVER ALL  
JOINTING MATERIALS PRODUCTS

## ROCK BINDING SOLUTIONS



**ROMEX - TRASS BEDDING - 55 LBS**  
009963



**ROMEX - ADHESIONAL ELUTRIANT - 55 LBS**  
009962



**SEK - EZ OVERLAY - 50 LB**  
009075



**SEK - SEK EZ SET - 50 LB**  
009076



**ROMEX - PROFI-DEKO ROCK BINDER**  
009910

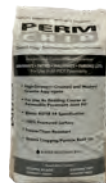

**SEK - PERMCHIP - 50 LBS**  
009071 - BLACK  
009072- TAN  
009073 - GREY



**GATOR - ROCK BOND**  
002464 - BINDER ONLY - 1 GAL  
007590 - BINDER KIT (ROCK & BINDER)



**GATOR AQUA ROCK**  
000194 - 2200 LBS  
001833 - 50 LBS

## ADHESIVES



**GATOR - BOND XP**  
007029 - 10oz  
007030 - 28oz



**SEK - SUREBOND ADHESIVES**  
009942 - SB-10 20oz  
009943 - SB-15 20oz



**PROSOCO ADHESIVE**  
008065 - 20oz



**PROSOCO - SAUSAGE GUN**  
009096 - FITS UP TO 20oz FORMATS



DISCOVER ALL PERMEABLE BEDDING SOLUTIONS, BINDERS & ADHESIVES PRODUCTS



## EDGING & BASE



**GATOR EDGE - 8FT**  
001828 - FLEX  
001829 - RIGID



**GATOR COMMON NAIL**  
001830 - 10"  
005144 - 12"



**GATOR EDGE - X4 - 8FT**  
015017



**GATOR EDGE  
MINI-PRO**  
005145



**SEK - SNAP EDGE - 8FT**  
009078



**GATOR SPACER**  
005148 - 1/4" - 6.4 mm  
005149 - 3/16" - 4.8 mm  
005150 - 1/8" - 3.2 mm



**GATOR BASE**  
007028



**GATOR SCREW**  
005147



**SEK - STEEL SPIKES**  
009082 - 8"  
009083 - 10"



**GATOR SPIRAL NAIL**  
005718 - 10 "  
005719 - 12"



**GATOR XTREME EDGE - 50 LBS**  
006016



**SEK - EDGECRETE - 50 LBS**  
009074

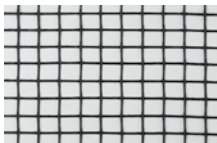

**TENCATE - GEOGRID GMG**  
006504 - 2XT, 12' X 150'  
006502 - 2XT, 4' X 50'  
001820 - 2XT, 6' X 150'

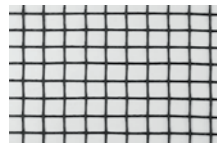

**TENCATE - GEOGRID GMG**  
001821 - 3XT, 6' X 150'  
001822 - 3XT, 12' X 150'

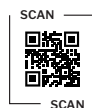

DISCOVER ALL  
EDGING & BASE PRODUCTS

## CLEANERS



### GATOR SHAMPOO

002421 - 1 GAL

002422 - 5 GAL



### GATOR EFFLORESCENCE CLEANER

002419 - 1 GAL

002420 - 5 GAL



### GATOR RUST REMOVER

002425 - 1 QUART



### ALLIANCE GATOR XP OIL & GREASE REMOVER

001884 - 1 QUART



### PROSOCO - 2010

006939 - 1 GAL

015061 - 5 GAL



### PROSOCO SAFETY - KLEAN

006990 - 1 GAL

015063 - 5 GAL



### PROSOCO - 600

006114 - 1GAL

015055 - 5GAL



### PROSOCO - VANATROL

008066 - 1 GAL

015064 - 5 GAL



### PROSOCO - LIGHT DUTY CONCRETE CLEANER

006940 - 1 GAL

015062 - 5 GAL



### PROSOCO - HEAVY DUTY CONCRETE CLEANER

070596 - 1 GAL

015065 - 5 GAL



### PROSOCO OIL AND GREASE

007499 - 1 GAL

015069 - 5 GAL



### PROSOCO CLEANER/DEGREASER

015066 - 1 GAL

015067 - 5 GAL



DISCOVER ALL  
CLEANERS PRODUCTS



## SEALERS



### GATOR SEAL - SATIN LOOK

002413 - 1 GAL

002414 - 5 GAL



### GATOR SEAL - WET LOOK

002415 - 1 GAL

002416 - 5 GAL



### GATOR - HYBRID SEAL LOW GLOSS

002459 - 1 GAL

002460 - 5 GAL



### GATOR SEAL - NATURAL LOOK

002417 - 1 GAL

002418 - 5 GAL



### PROSOCO - NATURAL STONE TREATMENT WB

008005 - 1 GAL

015071 - 5 GAL



### PROSOCO - SALTGUARD WB

007909 - 1 GAL

015070 - 5 GAL



### PROSOCO - SL100 WB

008082 - 1 GAL

015072 - 5 GAL



### PROSOCO - SAND JOINT STABILIZER

008155 - 1 GAL

015073 - 5 GAL



DISCOVER ALL  
SEALERS PRODUCTS



## TURF

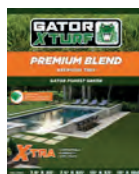

### ALLIANCE - GATOR XTURF PREMIUM BLEND FOREST GREEN

015018 - 15'X100'

015019 - 15'X33'

015020 - 7.5'X25'

015021 - 7.5'X50'

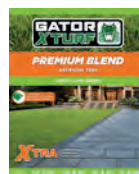

### ALLIANCE - GATOR XTURF PREMIUM BLEND LIME GREEN

015022 - 15'X100'

015023 - 15'X33'

015024 - 7.5'X25'

015025 - 7.5'X50'

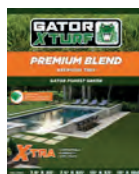

### ALLIANCE - GATOR XTURF CLASSIC BLEND FOREST GREEN

015026 - 15'X100'

015027 - 15'X33'

015028 - 7.5'X25'

015029 - 7.5'X50'



### ALLIANCE - GATOR XTURF CLASSIC BLEND LIME GREEN

015030 - 15'X100'

015031 - 15'X33'

015032 - 7.5'X25'

015033 - 7.5'X50'



### ALLIANCE - GATOR XTURF INFILL

015036 - Beige

015037 - Green

015038 - Zeo-White

## FIREPIT ACCESSORIES



### RECTANGLE WIND GUARDS

15198 - 43" X 15" X 6"



### SQUARE WIND GUARDS

15194 - 31" X 31" X 6"



DISCOVER ALL ACCESSORIES



## ADJUSTABLE PEDESTALS

Easy to adjust and support a suspended terrace using flagstones, granite or concrete slabs (on paver supports).

- Manufactured with fire retardant material.
- Height range from 0 to 3 feet (0 to 955 mm).
- Slope correction system from 0 to 5%.
- Enlarged surface area for an enhanced contact point.
- Installation made easier with material takeoff and plan layout service.
- Load capacity of 2,200 lbs (998 kg).



■ Fixed ■ Adjustable



### SPACER TABS



### TB-SHIM

The total height of the pedestal can be increased by 5/32 in (4 mm) (and stacked up to 4 high) perfect for minor height adjustment on site.



### SLOPE CORRECTOR TB-PH5

The TB-PH5 slope corrector is an adjustable unit which is placed under the base of the PB pedestal. It creates slopes of 0-5% in 0.5% intervals meaning a horizontal or inclined terrace can be easily installed. Note: Slope Corrector add 3/8 in (14 mm) in height.





# SELF-LEVELING MODULAR PEDESTALS



Based on the **3-in-1** concept, Uptec includes 3 base items that minimize inventory levels. The Uptec system can be assembled to any height and compensate for up to 5% slope of a structure's surface.

- Height of the pedestal can be adjusted from the top even when the floor is laid.
- Heads equipped with anti-slip and anti-noise rubber to reduce noise from footsteps and impacts.
- Made completely from 100% recycled and recyclable material.
- Pre-Scored base to facilitate placement on corners and perimeters.

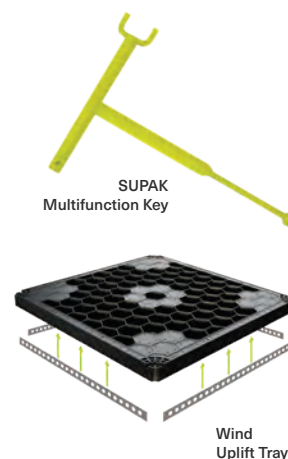

## EPD CERTIFICATION

Uptec is EPD certified. In building assessments, building products are evaluated through environmental product declarations (EPDs) conducted in accordance with ISO 14025 and EN 15804:2012+A2:2019.

The analysis evaluates the life cycle of the Uptec system and measures it in terms of carbon footprint with independent third-party verification of the statement and data, according to ISO 14025:2006. A series of case studies have shown that Uptec has an improvement of more than 70% in terms of carbon footprint over traditional methods of exterior floor assembly, such as glued tiles on a lightweight screed.









**NOW THAT THE JOB IS DONE,  
SEND US PICTURES OF IT!  
YOU COULD BE FEATURED  
IN OUR CATALOG!**

**WE'RE ALWAYS OPEN AT  
PHOTOS@TECHO-BLOC.COM**

**T—B**

# TECHO—BLOC

# TECHOSPEC

HARDSCAPER'S HANDBOOK

VOLUME 26

## USA

### ATLANTA

3908 Flint Hill Ext. SW  
Powder Springs, GA 30127

### CALIFORNIA

805 S. Kilroy,  
Turlock, CA 95380

### CINCINNATI

9950 Farr CT  
Cincinnati, OH 45246

### DETROIT

2210 Scott Lake Rd.  
Waterford, MI 48328

### ILLINOIS

8201 31st St. W  
Rock Island, IL 61201

### ILLINOIS

101 Serena Ct Minooka,  
Minooka, IL 60447

### INDIANA

2397 County Rd 27  
Waterloo, IN 46793

### MARYLAND

6710 Binder Ln.  
Elkridge, MD 21075

### MASSACHUSETTS

70 East Brookfield Rd.  
North Brookfield, MA 01535

### MINNESOTA

4372 170th St. W  
Farmington, MN 55024

### NASHVILLE

3603 Central Pike, Suite B,  
Hermitage, TN 37076

### NEW YORK

55-65 South 4th St.  
Bay Shore, NY 11706

### NORTH CAROLINA

5135 Surratt Dr.  
High Point, NC 27263

### OHIO

97 Industrial St.  
Rittman, OH 44270

### PENNSYLVANIA

852 W. Pennsylvania Ave.  
Pen Argyl, PA 18072

### PENNSYLVANIA

23 Quarry Rd.  
Douglassville, PA 19518

## CANADA

### MONTREAL

5255 Albert-Millichamp St.  
Saint-Hubert, QC J3Y 8Z8

### CHAMBLY

7800 Samuel-Hatt St.  
Chambly, QC J3L 6W4

### OTTAWA

581 Somme Street  
Gloucester, ON K1G 3Y3

### TORONTO

10 Freshway Dr.  
Vaughan, ON L4K 1S3

### TORONTO

2852 Cedar Creek Road  
Ayr, ON N0B 1E0

**TOLL FREE:**  
1.877.832.4625

**VISIT OUR WEBSITE:**  
[WWW.TECHO-BLOC.COM](http://WWW.TECHO-BLOC.COM)

**PROUD MEMBER OF**



CONCRETE  
**MASONRY &  
HARDSCAPES**  
ASSOCIATION

